



GENERAL CATALOGUE





“Sit down” è una delle prime espressioni che si apprendono studiando la lingua inglese, una frase che racchiude un tono imperativo, di comando. In realtà, l’atto del sedersi assolve a un’esigenza fondamentale dell’umano in quanto consente di far riposare l’intera muscolatura del corpo, lasciando ampia libertà di movimento. Nella sua essenzialità, la sedia, al pari degli altri complementi, è parte integrante del nostro vivere, in tutte le sue forme e manifestazioni. Praticità e comodità, funzione estetica, emotività e identità personale sono dunque fattori che si legano in modo indissolubile e di cui è indispensabile tener conto nella creazione dell’elemento d’arredo. Ecco perché possiamo parlare di filosofia del design, espressione dell’amore per la sapienza che sottostà la progettazione e la creazione di una seduta, di un divano, di un tavolo o di un qualsiasi altro complemento. Da anni, Segis è parte dello scenario più avanzato e di successo del design internazionale, di cui contribuisce a innovare i paradigmi creando complementi di estrema versatilità e bellezza. Il design Segis è “vivo”, concreto, pratico. Da molteplici competenze tecniche, produttive e creative e dalla collaborazione con importanti designer nascono pezzi dal grande valore iconico, oggetti quotidiani che trasformano il mondo che ci circonda e il nostro modo di vivere.

"Sit down" is one of the first sentences that is learned studying the English language, as if sitting were the easiest thing in the world. Many people, before taking a seat in a chair, observe how it is made and touch the material of which it is composed, if only they like it, sit down (provided that the chair is comfortable), otherwise change the chair. A chair is not a chair, but the mood created by sitting on it or just admiring it. That's why we can talk about design philosophy, a love of the wisdom behind designing and building a Chair, a sofa, a table or any other complementary item. For years, Segis is part of more advanced scenario internationally and innovates design paradigms by creating objects of versatility both functional and aesthetic. Segis design is "alive", concrete, practical. Different technical, productive and creative skills come together in a rich and original energy that flows from collaboration with clever designers. Each object has its own reason to exist and it's this meaning that emerges from the icons of product to represent the success of Segis. From the balance between ability and sensibility are born out everyday, necessary and ergonomic objects that change the world around us and our way to live it.

Le ragioni di una scelta

Segis nasce in Italia nel 1983, a Poggibonsi, ma la sua genesi culturale risale al Rinascimento, quando questo piccolo paese di antica storia, vicino a Siena, divenne famoso per la realizzazione artigianale di oggetti d'arredamento per le dimore patrizie.

Oggi il Gruppo Segis è uno dei leader mondiali nella progettazione e nella produzione di sedute innovative e di alta qualità per l'industria Contract. Dispone di strutture produttive tecnologicamente avanzate, su una superficie di circa quindicimila metri quadrati in Italia e settemila in Vietnam, con una base di assemblaggio, imbottitura, tappezzeria e distribuzione anche negli Stati Uniti. Da queste sedi Segis ha potuto espandere la penetrazione commerciale nei vari mercati, migliorando ovunque il controllo sui tempi di consegna e di servizio, senza per questo sacrificare il livello qualitativo. Tutte le strutture di produzione sono equipaggiate con le ultime tecnologie robotiche di piegatura, saldatura e verniciatura a polveri epossidiche di ultima generazione, capaci di far fronte a ogni particolare richiesta della clientela, da singoli ordini per uffici e ristoranti a progetti su larga scala, quali hotel e navi da crociera, dove il tipo e la qualità delle sedute rappresenta, con immediatezza, l'immagine in cui ogni singolo committente si riconosce e che desidera proiettare al mondo esterno.

Nel tempo, Segis ha contribuito a disegnare l'immagine globale e di marchio di conglomerati quali Grand Hyatt Hotels, Venice Laguna Palace Hotel, Marriott Hotels, Crown Casino, Disney Resorts, Group Accor Hotels, Union Bank

Of Switzerland, Carnival Lines, Art & Science Museums, Royal Yacht Club, Apple Computer, Microsoft, Mercedes Benz, Daimler Chrysler, Nestlé, AT&T, Swatch, Wimbledon, Mandarin Duck, Deutsche Bank, Chase Manhattan Bank, British Airways, Costa Cruise Lines, Eriksson, Leo Burnett, Lufthansa, il teatro dell'opera La Scala di Milano, Nortel Networks, oltre a numerosi caffè, ospedali, musei, aule universitarie e aeroporti, in ogni parte del mondo.

Oltre al suo design, vincitore di numerosi premi, Segis dedica la massima attenzione all'applicazione più rigorosa degli standard qualitativi internazionali. Implementa un programma di ricerca e sviluppo orientato alla continua ricerca dei migliori materiali e finiture, oltre al perfezionamento di un processo produttivo mirato all'ergonomicità del disegno, ma anche a rinforzare l'impegno aziendale in controlli di sostenibilità ambientale. Produrre prodotti di alta qualità non è però sufficiente per Segis, che continua a impegnarsi in rigorosi programmi di verifica e controllo, permettendo così di poter confermare alla clientela le garanzie richieste. La dedizione alla cura dei dettagli include anche una particolare attenzione alla qualità di un servizio dopo vendita che riflette quella dei processi produttivi e delle logistiche, perché considerata parte integrante del prodotto. La filosofia di Segis è affrontare ogni ordine come un'opportunità per accogliere nuovi clienti nel suo tessuto aziendale in continua crescita. È esattamente questo approccio personale, diretto e umano che continuerà a permettere a Segis di crescere insieme e in parallelo alla sua clientela.

Why Segis?

Segis was established in Italy in 1983, in Poggibonsi, but its cultural genesis dates back to the Renaissance, when this small town of ancient history, near Siena, became famous for developing handmade decorative objects for patrician and aristocrats.

Today, the Segis Group is a world leader in designing and manufacturing innovative, high-quality furniture for the Contract Market. Technologically advanced production facilities occupy an area of about 15,000 square meters in Italy and 7,000 in Vietnam. The United States has a base operation in TN of Assembly, Upholstery and Distribution to serve the US Market. From these locations, Segis could increase penetration into different markets, improving control over delivery time and service, without sacrificing the quality. All production facilities are equipped with the latest robotic technologies of bending, welding and epoxy powder coating. We are able to respond to requests from individual orders for offices and restaurants to large scale projects such as hotels and cruise ships, where the kind and the quality of the seatings is, immediately, the image in which every single customer is recognized and that want to project to the outside world.

Over time, Segis helped draw the overall image and brand of conglomerates such as Grand Hyatt Hotels, Venice Laguna Palace Hotel, Marriott Hotels, Crown Casino, Disney Resorts, Group Accor Hotels, Union Bank Of Switzerland, Carnival

Cruise Lines, Art & Science Museums, Royal Yacht Club, Apple Computer, Microsoft, Mercedes Benz, Daimler Chrysler, Nestle, AT & T, Swatch, Wimbledon, Mandarin Duck, Deutsche Bank, Chase Manhattan Bank, British Airways, Costa Cruise Lines, Eriksson, Leo Burnett, Lufthansa, the opera house La Scala in Milan, Nortel Networks, as well as numerous cafes, hospitals, museums, lecture theatres and airports, all over the world.

In addition to its design, winner of numerous awards, Segis devotes attention to stricter application of international quality standards. Implementation of a research and development program oriented to the continuous search for the best materials and finishes. In addition to perfecting a process aimed at ergonomics of design, Segis also reinforces the company's commitment to environmental sustainability controls. Producing high-quality products is not enough for Segis, which continues to engage in rigorous monitoring programs, allowing it to extend to customers the required guarantees. Dedication to detail also includes a focus on quality after sales service that mirrors that of the production processes and logistics, because it is considered part of the product. The philosophy of Segis is to approach each order as an opportunity to welcome new customers into its corporate fabric and continue to grow. It is precisely this direct and human personal approach that will continue to allow Segis to grow together and in parallel with its customers.

Politica di gestione

Da sempre Segis opera per produrre e commercializzare prodotti di design, basandosi su tre principi fondamentali: Qualità, Ambiente, Etica.

Qualità e certificazioni

Il Gruppo Segis ha conseguito un percorso di qualità che gli consente di essere leader in un mercato esigente come quello del Contract. Essendo un'azienda produttiva, ha dovuto integrare questo concetto a tutti i livelli: qualità di progetto, qualità di processo e qualità di prodotto. Della prima si fa carico in collaborazione con noti studi di architettura, implementando e ingegnerizzando, dove necessario, concetti stilistici e progetti più avanzati, per poi sviluppare dal prototipo alla pre-serie ed eseguire internamente i test prestazionali, secondo i principali standard internazionali. La qualità di processo è garantita dalla certificazione ISO 9001 del sistema qualità, che ha ottenuto nel 1998, tra le primissime aziende del settore, integrando questo sistema a ogni livello dei suoi processi (progettazione, produzione, logistica, servizi alla vendita e post vendita). Infine, la qualità di prodotto è garantita dall'applicazione delle più severe prove tecnico-prestazionali secondo gli standard ANSI Bifma e EN, tutte eseguite da laboratori riconosciuti e autorizzati.

Sostenibilità e Ambiente

Nell'antichità si realizzavano oggetti d'uso con il materiale che si aveva intorno, cercando di non alterare l'equilibrio ambientale. Oggi che le possibilità di sperimentazione sono infinite e l'intero pianeta è diventato fruibile, è importante non lasciarsi prendere dalla spinta dell'innovazione a danno dell'entourage e della natura. Per Segis, la qualità e la sostenibilità ambientale sono sempre stati principi fondanti, sin dalla nascita dell'azienda in uno dei paesaggi più belli al mondo, da preservare. Per questo, è sempre stata data la massima attenzione alla scelta di processi produttivi a basso impatto ambientale e ai controlli, severi sotto tutti gli aspetti: emissioni, scarichi e rifiuti. In coerenza con questi principi, già nel 2001, Segis ha conseguito la certificazione ISO 14001 per un sistema di gestione ambientale interno, con l'obiettivo di garantire il rispetto di norma riguardante la produzione e, soprattutto, di migliorare continuamente i limiti per tutti i reparti e le aziende del Gruppo.

Segis si impegna quotidianamente a studiare prodotti sostenibili, in modo da: mantenere sempre il massimo rispetto dell'ambiente / avere processi produttivi a basso impatto energetico / utilizzare materiali riciclati totalmente o in parte (quanto possibile) o riciclabili / ottimizzare i programmi di produzione al fine di ridurre gli scarti al minimo / usare finiture superficiali non inquinanti / non impiegare colle con presenza di formaldeide / controllare la filiera di fornitura per garantire il rispetto di questi principi, anche attraverso test di controllo per verificare l'assenza di sostanze volatili organiche (VOC) sui materiali. I prodotti Segis hanno ottenuto numerose certificazioni e riconoscimenti da vari enti, all'interno di progetti-quadro europei, da Legambiente e da consorzi produttivi (come ad esempio Casa Toscana Green Home).

Responsabilità Sociale

Quando si invita una persona a sedersi al proprio tavolo si dice "si accomodi". Ecco. Secondo il principio di accoglienza del Gruppo Segis, i collaboratori devono trovarsi a proprio agio sul posto di lavoro e i loro diritti devono essere rispettati a ogni livello. Per realizzare questa vocazione, è stata ottenuta la specifica certificazione SA8000 per la Responsabilità Sociale, che garantisce l'impegno dell'organizzazione aziendale in vari ambiti: garanzia di un posto di lavoro salubre per tutti i dipendenti / mantenimento degli impianti efficienti e affidabili in ambito di sicurezza / non impiego di lavoro infantile e minorile / nessun ricorso né sostegno ad alcuna forma di "lavoro obbligato", cioè di costrizione dei dipendenti a lavorare con ricatti di qualunque tipo / garanzia della salute e della sicurezza dei propri dipendenti e pieno rispetto delle norme di legge relative / garanzia della libertà delle organizzazioni sindacali e dei propri aderenti / assenza di discriminazioni di qualunque tipo dei lavoratori e fra i lavoratori / applicazione di procedure disciplinari nel pieno rispetto delle norme di legge / orario di lavoro rispondente ai requisiti di legge e agli accordi nazionali e locali / retribuzione corrispondente al Contratto nazionale e agli eventuali contratti integrativi aziendali / comunicazione all'esterno del proprio impegno al rispetto della norma SA 8000 / impiego di fornitori che rispettino anch'essi i principi di questa norma.

Management policy

As always, Segis works to produce and market designer products, based on three main principles: quality, environment, ethics.

Quality and certifications

The Group Segis holds a quality process that allows us to be a leader in a demanding market as that of the Contract. Being a manufacturing organization, we had to integrate this concept at all levels: project quality, process quality and product quality. The first takes charge in collaboration with famous architects, implementing and engineering, where necessary, style concepts and more advanced projects. We then develop from prototype to production and run the performance tests, according to international standards. Process quality is guaranteed by the ISO 9001 quality system, which we received in 1998. Segis was among the first companies in the sector, integrating this system at every level of its processes (design, production, logistics, sales and after sales services). Finally, the product quality is guaranteed by the application of the strictest technical and performance tests according to standards ANSI BIFMA and EN, all performed by laboratories approved and authorized.

Sustainability and Environment

In ancient times it cooperated on everyday objects with the material we had around, trying not to upset the environmental balance. Now that the possibilities for experimentation are endless and the whole planet became available, it is important not to get carried away by the force of innovation to the detriment of the entourage and nature. For Segis, quality and environmental sustainability have always been the founding principles, since the inception of the company in one of the most beautiful landscapes in the world, to be preserved. For this reason, it has always been given the highest attention to the choice of production processes with low environmental impact and strict controls in every aspect: emissions, effluents and waste. In line with these principles, as early as 2001, ISO 14001 certification for Segis has an internal environmental management system, in order to ensure compliance with rules as to production and, above all, to improve continually the limits for all departments and companies within the group.

Segis strives daily to study sustainable products, so: always keep the utmost respect for the environment / have low energy production processes / use recycled materials in whole or in part (where possible) or recyclable materials / optimize production schedules in order to reduce waste to a minimum / use non-polluting surface finishes / do not use glues with presence of formaldehyde / check the supply chain to ensure respect for these principles, including through control test to verify the absence of organic volatile substances (VOC) materials. Segis products have obtained numerous certifications and recognitions from various organizations, within the framework of European projects, from Legambiente (such as Casa Toscana Green Home) and production consortia.

Social Responsibility

When you invite a person to sit at their desks, it says "have a seat". According to the Principle of Reception for Group Employees at Segis, they must feel at ease in the workplace and their rights must be respected at all levels. To accomplish this vocation, we obtained the specific certification of SA8000 for social responsibility, which guarantees the commitment of the Organization in various areas: guarantee of a healthy workplace for all employees / maintenance of efficient and reliable security systems / no use of child labour / no remedy and no support to any form of "forced labour", that is coercion of employees working with blackmail of any type / guarantee the health and safety of its employees and full compliance with the law / ensuring freedom of trade unions and their members / no discrimination of any kind of workers and among workers / application of disciplinary procedures in full compliance with the law / working time fulfils the legal requirements of national and local agreements / salary corresponding to the National Agreement and any supplementary business contracts / communication outside of their commitment to the respect of the SA8000 standards / use of suppliers who respect themselves the principles of this standard.



(2005) Ethical Behaviour management system certified according to SA8000 Certificate no.064 - for Social Responsibility.



(1998) Quality management systems certified according to ISO 9001:2015 (registration IT4646)

(2001) Internal Environmental management system certified according to ISO 14001:2015 (Registration IT23310)



The mark of responsible forestry
FSC™ C155379

(2020) Ask for our FSC™ - certified products.

Premi / Awards

CAMEL

Bartoli Design

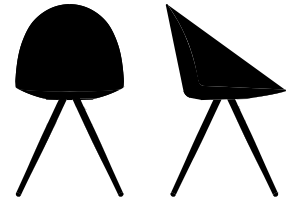

2018

Golden Key Award - Belgrade Furniture Fair

DRAGONFLY

Odo Fioravanti



2016

Honorable Mention XXIV Compasso d'Oro Award from ADI / France. Winner at Born Awards 2016

2015

Nominated for "Designs of the Year 2015" London Design's Museum

2014

Italy, exposed at Design Café, Triennale di Milano / Selected from ADI Design Index / U.S.A. winner of 2014 IIDA/HD Product Award for the Dining Seating Category / Nominated "Best of Year Awards" for the Seating category: contract-guests

HAMMER

Favaretto & Partners

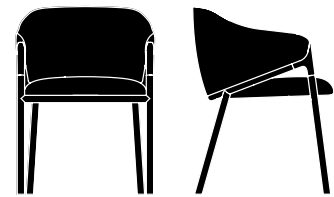

2019

I.F. Design Award

2018

Red Dot Award Product Design

2017

Good Design Award by the Chicago Athenaeum for Design Excellence and Innovation

RIVER

Bartoli Design



2014

U.S.A. winner of 2014 IIDA/HD Product Award - for the Lounge Seating Category

DERBY

Archirivolto Design

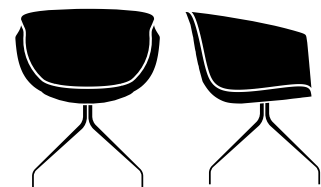

2016

U.S.A. winner of 2016 Adex Award for Design Excellence – Platinum Award.

BREEZE

Carlo Bartoli



2004

Italy - Selected for the "Coffee Design" collection by the Triennale di Milano Breeze sales reaches 1,000,000 units.

2000

Italy - Selected for Commemorative Stamp Collection by the Italian Postal Service.

1996

Germany - Vitra Design Museum. Greece - Thessaloniki Design museum. USA - I.D. Design Distinction Award I.I.D.A. Apex Product Design Ward Germany - High Design Quality Award I.F. Design Award Red Dot Design Award from Design-Zentrum Nordrhein Westfalen.

UNO

Bartoli Design & Fauciglietti Engineering

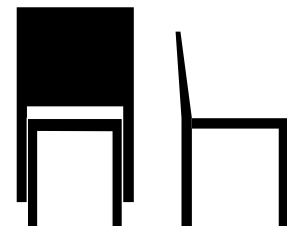

2008

XXI Compasso D'Oro Prize from ADI

2004

Materialica Design Award.

BLISS

Bartoli Design

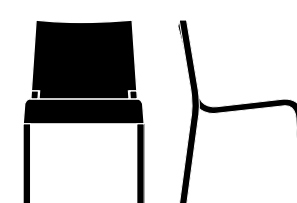

2004

U.S.A. - Selected for exhibition at the San Francisco Museum of Modern Art.

CAPO FAMIGLIA COLLECTION

Studio Mussapi

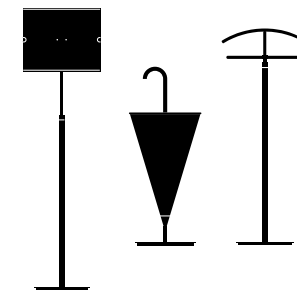

2004

U.S.A., Contract International Award.

PACIFIC

George J. Sowden

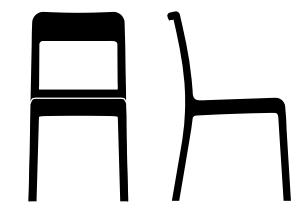

2004

Italy - Designated as an Environmentally Friendly Product by Casa Toscana Green home which certifies the environmental quality of furniture products thru their life cycle analysis. / Italy - Selected for the "Coffee Design" collection by the Triennale di Milano / USA - ADI index Selection.

NAMI

Paolo Crescenti

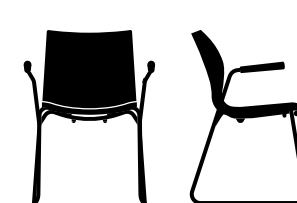

2002

Canada - INDEX Gold Award.

NOON

Archirivolto Design

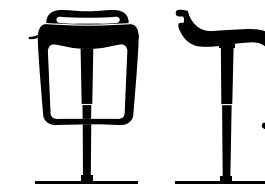

2002

Italy - Designated as an Environmentally Friendly Product by Casa Toscana Green home which certifies the environmental quality of furniture products thru their life cycle analysis.

PLEASE

Isao Hosoe



1999

USA - Good Design Award.

BLITZ

Carlo Bimbi Paolo Romoli

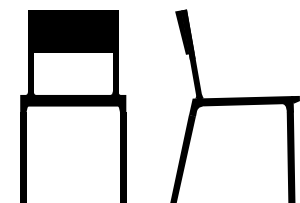

1999

USA - "I.D. Design Distinction Award", "I.I.D.A Apex Product Design Award".

STORM

Carlo Bartoli

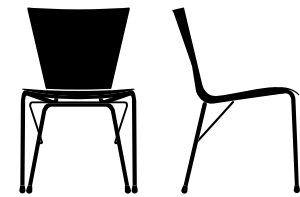

1996

Greece - Thessaloniki Design Museum.



ADI / Design Index

Sigma, Lambda Roberto Romanello Cloud, Carlo Bartoli Capo-Banda, Studio Mussapi Downtown, Anna Castelli Ferrieri Ellipse Collection, Bartoli Design Mistral, Bartoli Design Trono, Sottsass Associati Uno, Bartoli Design & Fauciglietti Engineering Slide, Matteo Thun with Antonio Rodriguez Pacific, George J. Sowden E-motion, Giancarlo Piretti

Realizzazioni / Installations

United States, Canada, South America

Hospitality / Resort

Carnival Cruise Fleet, Miami
Hyatt Regency Bellevue, Washington
Hilton Hotels, various US locations
Marriot Hotels, various US locations
Palace Station Hotel, Las Vegas
Paramount Studios, Hollywood
Residence INN –hotel, DOWntown Raleigh, NC

Restaurants / Coffee Shops

Ernst &Young cafeteria, Santiago
Hagen Dazs ice cream shops, Buenos Aires
Starbuck Coffee, various US locations
Worlds Sport Cafe, Buenos Aires

Sporting Facilities

Chicago Bears Stadium, Chicago
Cleveland and Indians Baseball team, Cleveland
National Jockey Club, Cicero (NY)
New Jersey Devils Stadium, New Jersey
Qualcomm Stadium, San Diego
San Diego Padres Baseball Club
US Tennis Open championship, NYC
USTA - National Tennis Association Flushing, NY

Aviation / Transportation

Atlanta Airport, Atlanta
Bob Hope USO at Lax Airport, Los Angeles
El Al Israel Airlines Vip Lounge, JFK Airport, NY
New Orleans Airport, New Orleans
Toronto International Airport, Toronto

Corporate

Atlas Copco, Chile
Bank Itau, Chile
Bunge International, St.Louis, MO
Canon Headquarter, Santiago
Check R Headquarters San Francisco, California
CMC Corporate Service, Toronto
Coca Cola office, various US locations
Concert Properties, Toronto
Girl Scouts of America, Houston
Google Office, Chile
Google Office, various US locations
IBI Group, Toronto
International Tobacco Headquarters, Toronto
National Car Rental Headquarters, Ft. Lauderdale
Nissan Automobiles dealerships, various locations
Nokia, Chile
Procter & Gamble Co., Cincinnati
Quad Real , Calgary

Retail

Adidas shops, Chile
Bon Marché dept. stores, various locations
Children Hospital, West Chester
Clear Channel, Minnesota
Dallas Market Center, Dallas
East Ridge Shopping Mall, San Jose, CA
Edgar Cayce Center-Holistic Health Center, Virginia Beach
L'Oreal Shops, Toronto
Luxottica, various US locations
Nemours Hospital, Orlando
Oakwood Mall, Hammond, Louisiana
Spence Diamonds, various US locations
United Health Care, Boston
Wyatt Jonson Toyota, Dealership

Healthcare

American Society of Gastroenterology Healthcare facility, Chicago
Children Hospital, West Chester
Edgar Cayce Center-Holistic Health Center, Virginia Beach
Healthcare Facility, Chicago
John Hopkins Hospital Servery, Baltimore
Nemours Children Hospital, City Wilmington
Nemours Hospital, Orlando
St. Jude Hospital, Memphis, TN
United Health Care, Boston
Wake Forest Baptist Hospital, Durham, NC
Westchester Hospital, Maryland

Educational / Institutional

Art Museum, Milwaukee (WI)
Boreal University College, Toronto
Brava Compass Bank , Birmingham
California Science Center, Los Angeles
Chabad Jewish Centre (synagogue) , Vancouver
Choctaw Indians Courthouse, (MS)
East Brampton Community Center and Library, Brampton-Toronto
EDLS -Eugene Dupuch Law School, Bahamas
Ellis Don – Courthouse, St Thomas, Canada
Exploratorium Connector Gallery, San Francisco
Forsyth County Public Library, Winstom Salem, NC
Government Offi ces, Kansas City
Miami Dade College (MDC), Florida
Middletown High School, Ohio
Mississauga Library, Toronto
Museum of Fine Arts, Boston
National Civil Rights Museum, Memphis
Natural History Museum, Los Angeles
North Caroline State University, Raleigh North Caroline
Northwestern University, Sioux Falls (SD)
Paul Getty Museum, Los Angeles
Pentagon Eatery, Washington DC
Poder Judicial, Santiago, Chile
Press Room, Washington DC
Ripley Sea Aquarium, Long Beach (CA)
Royal Canadian Police headquarters, Vancouver
San Diego Estate University
Schulic School of Business, Toronto
Science Museum, St. Paul (MN)
Syracuse University, Syracuse, NY
Tech Town Chattanooga, Chattanooga
The Diane B.Wilsey Center for Opera, San Francisco
Texas Souther University Library
Universidad Finis Terrae, Santiago
University of Central Florida, Orlando
University of Delaware, Wilmington
University of Michigan, Ann Arbor (MI)
University of Nebraska, Lincoln, NE
University of Utah
Univerisyt of Wisconsin “Eau Claire”, Eau Claire
University of Wisconsin, Madison Wisconsin
University of Kentucky
Villanova University, Philadelphia
Washington University, Washington
Waterford 51st District Court, Waterford (MI)
Zachry Hall Texas A&M University, Texas

Australia, New Zealand

Hospitality / Resort

Grand Hyatt Hotel, Melbourne
Melbourne Exhibition & Convention Centre
Sydney Convention Centre

Restaurants / Coffee Shops

Café 21, Sydney
Crown Casino restaurants, Melbourne
RACV Royal Pines Resort - Kalinda Restaurant, Brisbane
RSPCA Victoria, (Animal clinic)
Watermark Restaurant, Canberra

Sporting Facilities

Essendon Football Club, Melbourne
Melbourne Cricket Club, Melbourne
North Harbor Stadium, Auckland
Royal Automobile Club, Victoria
Royal Motor Yacht Club, Sydney
Werribee Sports & fitness Center, Melbourne

Aviation / Transportation

Perth Airport
Sydney International Airport, Sydney
Virgin Airlines headquarters, Brisbane
Wellington International Airport, Wellington

Corporate

AGC Security, Victoria
Apple Computer headquarters, Sydney
Barwon Water, Melbourne
DHL corporate, Sydney
Fisher & Parkel headquarters, Auckland
Future Fund Management Agency, Melbourne
GGU Insurance, Victoria
IBM Office, Victoria
Macquarie Bank, Sydney
Mazda Headquarter, Melbourne
Medibank Private headquarters, Melbourne
Nestlé headquarters, Sydney
Renault Automobiles dealership, Melbourne
Western Mining headquarters, Perth

Retail

Box Hill Shopping Center, Melbourne
Clifford Garden Shopping Center, Queensland
DFO Moorabbin Shopping Center, Victoria
Grand Plaza Food Court Shopping center, Queensland
Hyperdome Shopping Center, Canberra
Stocklands Wetherill Park Shopping Center, Sydney
Taigium Square - shopping center, Queensland
Westfield Miranda Shopping Center, New South Wales

Healthcare

Ebos Healthcare, Melbourne
Neuroscience Research, Randwick, New South Wales
Numurkah District Health Service, Melbourne
Royal Melbourne Hospital, Melbourne

Educational / Institutional

Anglican Church, Sydney
Ararat Prison, Victoria
Australian Department of Justice, Melbourne
Catholic Ladies'College, Melbourne
Davanport Living City, Davonport, Tasmania
Deakin University, Waterproof Campus in Geelong, Vic
Department of Defense, Canberra
Haileybury College, Melbourne
Islamic College of Melbourne
La Trobe University, Melbourne
Marion Cultural Centre, Adelaide
Melton Library & Learning Center, Melbourne
Monash University, Melbourne
Presbyterian Ladies College, Melbourne

Ringwood Library, Melbourne
Siena College, Melbourne
Skycity Casino, Darwin
St Andrews Cathedral School, Sydney
St. Josephs College,Melbourne
The National Museum of Australia, Canberra
The Papua Museum, Wellington
Victoria University-Footscray Campus in Melbourne
Wellington University, Wellington

Far East

Hospitality / Resort

Disneyland Resort Headquarters, Tokyo
One Farrer Hotel and Spa, Singapore

Restaurants / Coffee Shops

Bayside Restaurant, Yokohama
Caffetteria Spinelli, Singapore
Carnegie Bistrò, Singapore
Coffee Club Lounge, Singapore
Crematis Garden Wedding Palace, Tokyo
Disneyland Resort restaurants, Tokyo
Dragon-i Restaurant & Lounge, Hong Kong
Holland Valley Food Mall, Singapore
Manchester United Coffee Shop, Singapore
Overseas Coffee Shop, Singapore
Ribbon Beef Coffee Shop, Singapore
Rokkatei Restaurant, Sapporo
Sisui Food Court, Tokyo

Aviation / Transportation

Tokyo International Airport, Tokyo

Corporate

BMW, Beijing
China Trust Bank, Taipei
CISCO Globalisation, Bangalore
Facebook office, Singapore - India
FMC - Technologies, Singapore
Great Eastern Insurance, Singapore
Hewlett-Packard, Shanghai
IBM Malaysia
ING Bank N.V, Singapore
Japan Am-Way headquarters, Tokyo
Microsoft, Singapore
Ngee Ann Polytechnic-school, Singapore
Philips headquarters, Singapore
Pt. Schlumberger Geophysics Nusantar, Jakarta
Sengank Library, Singapore
Taishing Bank, Taipei
Union Bank of Switzerland headquarters, Singapore
Union Bank of Switzerland headquarters, Tokyo

Healthcare

NTFG Hospital, Singapore

Educational / Institutional

Australian Embassy, Tokyo
Bunkyo University, Bunkyo
Ministry of National Development, Singapore
National University of Singapore, Singapore
Taipei New Horizon Convention Center, Taipei
Tokai University Hospital, Tokyo
University of Science, Tokyo
Katayanagi Gakuen School, Tokyo
Kunitachi College of Music, Tokyo

Realizzazioni / Installations

Middle East

Hospitality / Resort

Ibis Hotel, Dubai
TwinTower Hotel, Doha

Restaurants / Coffee Shops

Israel Air Force VIP restaurant, Tel Aviv

Sporting Facilities

Lifeline Slimming Gynmasium Centre, Abu Dhabi

Corporate

Bank Saradar, various locations in Lebanon
Broadcom, Israel
Borouge Innovation Center, Abu Dhabi
Comverse headquarter, Israel
DNATA-Dubai National Air Travel, Dubai
Dubai World Trade Center
Eurovision International, Jerusalem
Grand Canyon Shopping Mall, Haifa
International Company West Pharma, Tel Aviv
Microbot Medical Ltd, Tel Aviv
MIGDAL Insurance Company, Tel Aviv
Perfecto Mobile, Tel Aviv
Philips Headquarter, Tel Aviv
World Trade Centre, Dubai

Healthcare

Asuta Hospital, Tel Aviv
Belison Hospital, Dubai
Barzilai Medical Center in Souther Israel
Das Hospital, Abu Dhabi
Jerusalem Belison Hospital, Jerusalem
Mina Al Fahal Center, Muscat
Medical Clinics (MDC), Tel Aviv
Wizman Science Institute, Rehovot
Ziv Medical Center, Tzfat

Educational / Institutional

Antonine International School (AIS), Beirut
Cinema City, Jerusalem
Grand Cinema in ABC Mall, Beirut
Louvre Museum, Abu Dhabi
Noura Princess University, Riyadh

Aviation / Transportation

Israel Airport Ben Gurion Terminal 3, Israel

Europe, North Africa

Hospitality / Resort

43 Station Hotel, Milano
Accor Ibis, Milano
Amalthia Hotel, Papos
Club la Costa, Malaga
Club Mediterranee, Ragusa & other locations, Italy
Euro Disney Restaurants, Paris
Faro Ria Hotel, Faro
Flotta Costa Crociere
Grand Hotel Senator, Ayia Napa
Group Accor, various locations , Europe
Holiday Inn Hotels, various locations, Italy
Holiday Inn Nicosia, Limassol
Hotel Don Carlos, Marbella
Hotel Grand Chalet, Athens
Hotel Le Soleil Restaurant, Jesolo
Hotel Pousada de Alcacer do Sal
Hotel Pullman, Marrakech
Laguna Palace Hotel, Venice
Monte Prado Hotel, Prado
Novotel, Lisbon
Penta Hotel Eisenach, Eisenach
Sofitel, Paris

Restaurants / Coffee Shops

Afroditi Restaurant, Athens
Alcatel Coffee Shop, Paris
Alsthom Restaurant, Paris
Antzoki Zaharra Restaurant, Bilbao
Bar Mascalzone Latino, Isola d’Elba
Bar Sea Breeze, Salerno
Bluebird Cafe, London
Cafe Opera, Stockholm
Caffè Fellini, Prague
Dash Restaurant, Athens
Dockx coffee shop, Antwerp
EniserviziCanteen, severallocations, Italy
Floridita Cafe, Prague
Goody’s Restaurant, Athens
Grandi Navi Veloci Restaurant
Hotel Ibis, restaurant area, France - various locations
Il Cantiere Restaurant, Fano
Kentucky Fried Chicken restaurant, Lamaca
Les Palaces coffee shop, Porto
Mallorca coffee shop, Madrid
Mc Donald’s Restaurant, Helsinki
Mc Donald’s Restaurant, Antwerp
Ondo Ondo Restaurant, Pamplona
Orient Express Restaurant, Railway Station, Stockholm
Praja Major disco bar, Braga
Pralina Cafe restaurant, Nicosia
Rendez Vous restaurant, Prague
Resch Cafe, Wels
Restaurant Le Bateau Parisienne, Paris
Restaurant Le Cocteau, Saint Quentin
Rodilla coffee shops, Madrid and various locations
Vertigo Terras, Amsterdam

Sporting Facilities

Boa Vista Stadium, Porto
Federation de Golf, Utrecht
Golf National, Guyancourt
Hockenheim F1 racetrack VIP Lounge
Irish Sport Council, Dublin
Olympiapark, Munich
Palmeriaie Golf Palace, Marrakech, Morocco
Ptuj International Golf Resort, Ptuj
Stade de France, Paris
Stade de Gerland, Lyon
Tennis Club “ Roland Garros”, Paris
Wimbledon Tennis & Sport Facilities, London

Aviation / Transportation

British Airways headquarters, London
Civil Aviation headquarters, Paris
Dublin Port Authority, Dublin
Gothenburgs Airport, Landvetter
Hamburg Airport, Hamburg
Heatrow airport, London
Kevlavik airport, Kevlavik, Iceland
Lanzarote International Airport, Lanzarote, Canary Island
Lufthansa Training Center, Frankfurt
Malpensa International Airport, Milan
Railway Central Station, Bruxelles
Rome International Airport, Rome
Saint Petersburg airport, Russia
Toulouse-Blagnac Airport, Toulouse
Vignadivalle Airport Headquarter

Corporate

Advania Company, Reykjavik
Aldi Headoffice Co., Dublin
Allianz, Paris
Aquopolis Costa Dorada, Tarragona
AT&T Headquarters, London
Autogrill motorway restaurants, several locations, Italy
Banca Commerciale Italiana headquarters, London
Boheringer-Ingelheim headquarters restaurant, Florence
Bord Gais, Dublin
British Telecom headquarters, London
Canon headquarters, Malmö
Cariparma, Centro Servizi Cavagnari, Parma
Chase Manhattan Bank, Nottingham
City Bank, Budapest
Coca Cola headquarters restaurant, Amsterdam
Daimler-Chrysler, Dresden
Deutsche Bank, several locations, Germany
DHL headquarters, Diegem
DZB Leiden Office, Lederdorp
Electrolux headquarters, Stockholm
Elleniki Technodomiki SA, Athens
Ericsson employees restaurant, Rome
Euro Plaza Center, La Défense
Equifax Office, Leeds
Ferrari Automobiles, Maranello
Giostyle showroom, Milan
Grey Communications headquarters, Copenhagen
Hewlett Packard headquarters, Wien
Jarowsky Television Network, Stockholm
Jazz Pharma Headquarter, Villa Guardia, Como
Leo Burnett headquarters, Copenhagen
Mandarina Duck headquarters, Bologna
Maserati Automobiles, Modena
Mercedes-Benz of Denmark, Hørsholm
Metropolis multiscreen movie theatre, Frankfurt
Microsoft headquarters restaurant, Dublin
Montblanc Shop, Hamburg
Nortel Network headquarters, Den Haag
NKG Spark Plugs, Meung sur Loire
Ote Greek National Telephone Company, Athens
PTT Telecom headquarters restaurant, Engelo
Railway Central Station, Bruxelles
Saab-Scania headquarters, Stockholm
Sächsische Landesbank, Fresden
Sadler’s Well theatre, London

Sanofi Headquarter, Paris
Sparkasse, Aachen
Sun Microsystems headquarters Restaurant, Kista
Swatch headquarters, Athens
Telecom Italia Mobile calling centers, Italy
The Bank of Greece, Athens & other locations
The Bank of Italy, Rome
The House of Music, Parma
The Italian Parliament restaurant, Rome
VIP Fitness Center, Bruxelles
Vodafone-Omnitel break areas, Italy
Volkl trade fair displays, Munich
Volksbank, Mönchengladbach

Retail

Factory shopping mall, Seville
Feira Nova shopping mall, Sintra
Geant Casino, Amiens
Ikea, Bayone
Palace Flora shopping mall, Prague
Shopping Center, Veliz
Shopping Center, Auchan, France, various locations
Shopping Center Leclerc, Estancarbon
Shopping Center Les Authieux, France
Shopping Park Otrada, Russia
Twin Towers shopping mall, Lisbon

Healthcare & Institutions

Aboriginal Art Museum, Utrecht
Alfredo da Costa Medical Center, Lisbon
Alte Pinakothek, Munich
American Hospital, Paris
Centre Hospitalier Genk, Belgium
Clinique Mutualiste de l’Estuaire, Saint Nazare
Cromwell Hospital, London
Hvidovre Hospital, Hvidovre
Industrial Design University, Florence
Istitut Gustav Roussy, Villejuf Cedex
Irish Department of Education, Dublin
IUC Oncopole, Toulouse
John Moore University, Liverpool
Klinikum Garmisch, Partenkirchen
Museum of Ireland life, Castlebar
Museum of Modern Art, Thessaloniki
Ospedali Riuniti di Bergamo
Otokos University, Athens
Psychiatrishe Klinik, Wiesbaden
Royaumont Abbey, Royaumont
Saint Crispopher Foundation, Nicosia
Scala Theatre Museum, Milan
The C.R. Mc Intosh House Museum, Glasgow
Tor Vergata Hospital, Rome
Universität, Duisburg
University of Lisbon, Lisbon
University of Saragozza, Saragozza
University of Siena, Siena
Waterford Institute of Technology

Educational / Institutional

Auditorium Vivaldi, Turin
Centre Culturel de Marrakech, Marrakech
European House, Vilnius, Lituania
Fondazione Residenza Amica ONLUS, Giussano
Groupon Office, UK
Institut d’etude Politiques, Bordeaux
Politecnico di Torino, Turin
PTV Policlinico Tor Vergata, Rome
Town Council, Noisy
Town Council, Periguex
Kedge University, Talence
Komida Campus Middelheim, Antwerpen
Sadler’s Theather Wells, London
University Santa Chiara, Siena
Université Européenne de Bretagne, Brest

Designers



Basaglia + Rota Nodari



Altherr Désile Park



Orlandini Design



Archivolto Design

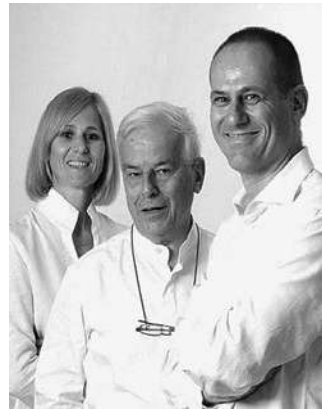

Bartoli Design

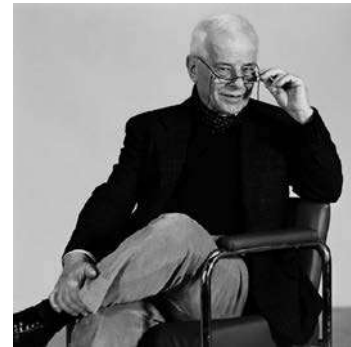

Carlo Bartoli



Massimiliano Mornati



Alejandro Valdés

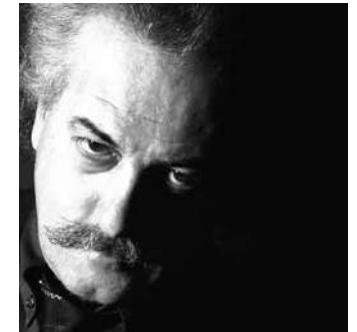

Vegni



Carlo Bimbi



Cisotti & Laube



Odo Fioravanti

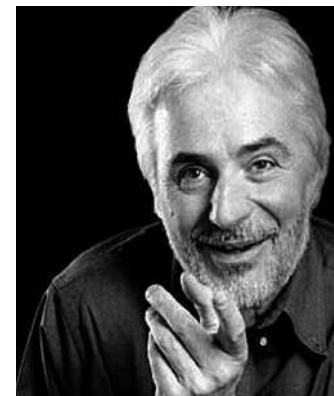

Giancarlo Piretti



Roberto Romanello

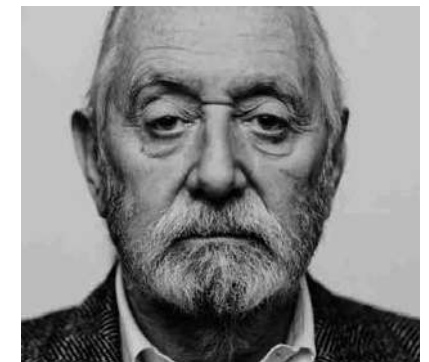

Sottsass Associati



Favaretto & Partners



Lucci & Orlandini



George J. Sowden



Matteo Thun



Luigi Trenti



INDEX

NOVITÀ / NEWS / NOUVEAUTÉS / NEUHEITEN

22



CARELL
24



RION
30



TWIRL
46



ARTFUL IRON
54



SAMU
62

ICONE / ICONS / ICÔNES / IKONEN

64



E-MOTION
66



SLIDE
70



TRONO
74



UNO
78

SEDUTE / SEATING / CHAISES / STÜHLE

82



BILLA CHAIR
84



BREEZE
88



CAMEL
92



CROSSING
104



CULT
108



CULT WOOD
116



DERBY
118



DRAGONFLY
124



GRACE
136



HAMMER-S
142



NAMI
150



PACIFIC
158



POLO
162



POPPYSTAR
168



STAMP
176



TO-BE
200



TO-BE OUTDOOR
206

TAVOLI / TABLES / TABLES / TISCHE

214



AGORÀ
216



AGORÀ DOUBLE
216



ARTFUL
222



BOOM COLLECTION
228



COMPASSO
236



CONI
240



CULT
244



EASY BOY
248



EASY BOY SMART
248



Y-BOY
248



FOLD UP
258



HOTEL
264



JUXT
268



K COLLECTION
272



LONGWAY TABLE
278



POLO
282



SAMU
288



SLIM
294



STAY-ON
298



TIN-MAN
302



TOP&STOP
304



AGORÀ
310



ALPHABET COLLECTION
318



BE-ON
326



BILLA LOUNGE
330



CARELL
336



CROSS
344



FLORES
350



HAMMER-M/L
356



HOTEL
364



LONGWAY
378



NOLDOR
398



OSCAR
408



REY
414



SKYLAN
420



STEAK&STILTON
430



TERMINUS
436



ELLIPSE COLLECTION
442



NOVITÀ
NEWS
NOUVEAUTÉS
NEUHEITEN

CARELL

Alejandro Valdès

Poltroncina dal forte carattere grafico, essenziale nelle linee ma dall'aspetto sofisticato, indicata per ambienti healthcare, ristoranti, sale riunione. Struttura in profilato di tubo di acciaio ovale verniciato a polveri epossidiche e braccioli in legno massello rovere.

Armchair with a strong graphic character, essential in the lines but with a sophisticated appearance, suitable for healthcare environments, restaurants and working spaces. Frame in oval steel tube profile with powder coated finish and armrests in oak solid wood.

Fauteuil au fort caractère graphique, aux lignes épurées mais à l'aspect sophistiqué, indiqué pour les environnements de santé, restaurants et salles de réunion. Structure en profilé de tube d'acier ovale avec finition époxy laquée et accoudoirs en chêne massif.

Sessel mit starkem grafischen Charakter, essenziell in den Linien aber mit einem raffinierten Look. Geeignet für Gesundheitswesen, Restaurants und Arbeitsräume. Gestell aus pulverbeschichtetem ovalem Shahlrohrrahmen und Armlehnen aus massiver Eiche.

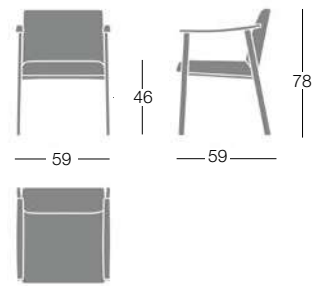

S0130

Finiture / Finishes / Finitions / Ausführungen

Struttura / Frame / Structure / Gestell

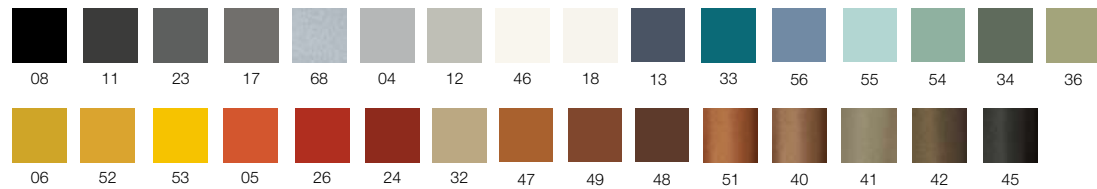

Legno / Wood / Bois / Holz

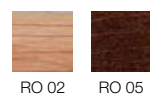

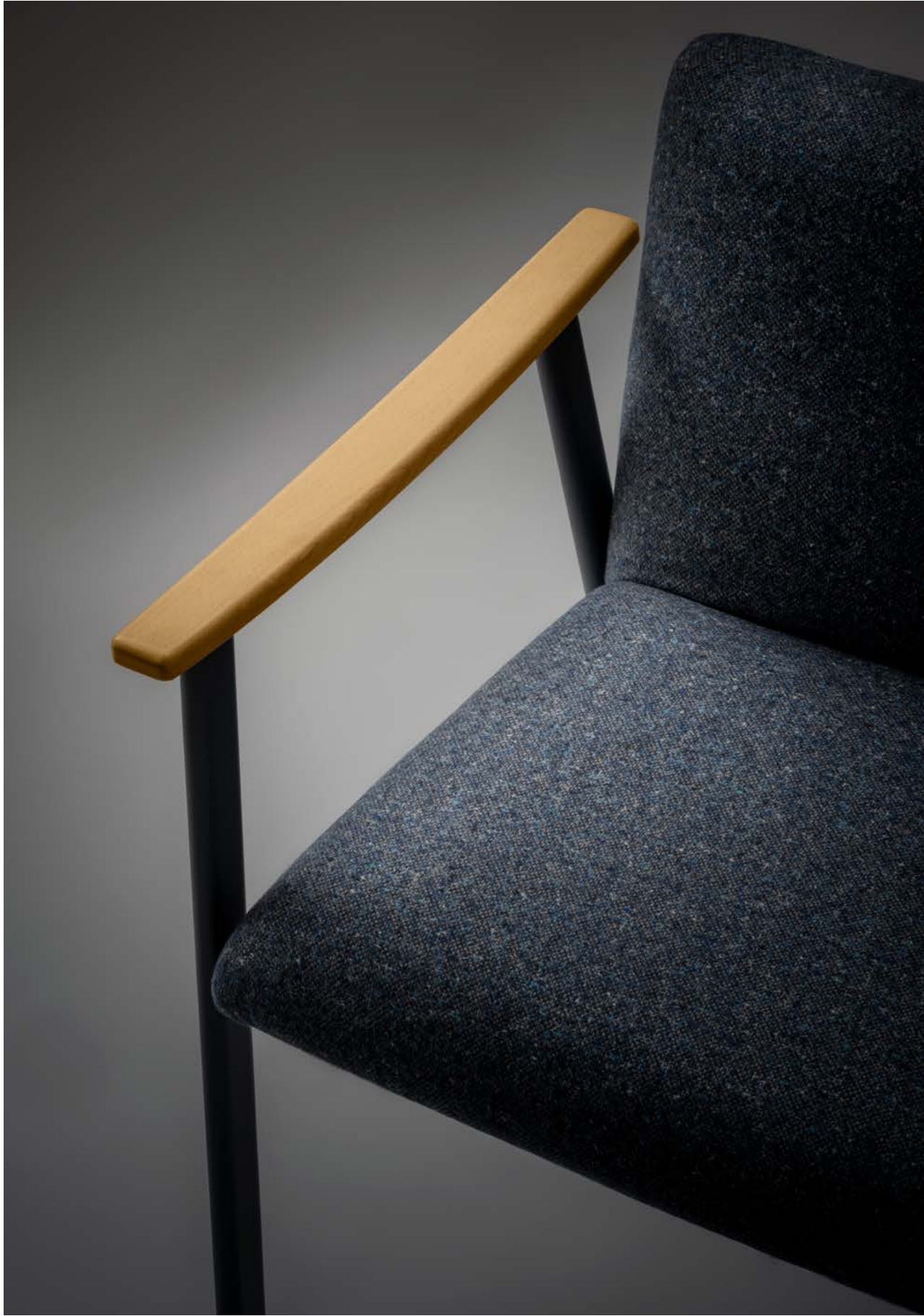



RION

Redesign Basaglia + Rota Nodari

OMAGGIO DI SEGIS A CARLO BARTOLI IRON diventa RION REDESIGN

Basaglia + Rota Nodari.
La sedia IRON disegnata da Carlo Bartoli nel 2009 si presenta in una nuova veste, che restituisce, attualizzandolo, il valore intrinseco di una seduta senza tempo disegnata da uno dei maestri del Design Italiano. Basaglia + Rota Nodari sono intervenuti sul progetto IRON, attraverso un processo di redesign che rappresenta un fil rouge che unisce passato presente e futuro di un'azienda in continua evoluzione come Segis. RION è una sedia dalle linee sfuggenti, leggera e resistente, perfetta per il mondo della Community, può diventare protagonista nel settore dell' Hospitality. Una struttura in tondino di metallo o in tubolare, nella versione a quattro gambe, regge una seduta ed uno schienale in polipropilene. È disponibile in numerose versioni e colori anche tono su tono.

SEGIS'S TRIBUTE TO CARLO BARTOLI IRON becomes RION REDESIGN

Basaglia + Rota Nodari.
The IRON chair designed by Carlo Bartoli in 2009 presents itself in a new guise; its updating restores the intrinsic value of a timeless seat designed by one of the masters of Italian Design. Basaglia + Rota Nodari intervened on the IRON project through a redesign process that represents a common thread uniting the past, present and future of a continuously evolving company like Segis. RION is a chair with elusive lines, light and resistant; it will become a protagonist in the Hospitality sector. Four-legged models feature a metal rod or tubular structure supporting a polypropylene seat and backrest. RION is available in numerous styles and colours, including tone-on-tone.

HOMMAGE DE SEGIS À CARLO BARTOLI IRON devient RION REDESIGN

Basaglia + Rota Nodari.
La chaise IRON conçue par Carlo Bartoli en 2009 se présente sous un nouveau look, qui restitue, en l'actualisant, la valeur intrinsèque d'un siège intemporel conçu par l'un des maîtres du Design Italien. Basaglia + Rota Nodari sont intervenus sur le projet IRON, par un processus de redéfinition qui représente un fil rouge qui unit passé présent et futur d'une entreprise en constante évolution comme Segis. RION est une chaise aux lignes élusives, légère et résistante, parfaite pour l'univers de la Collectivité, elle peut devenir protagoniste dans le secteur de l'Hôtellerie. Une structure en tige de métal ou en tube, dans la version à quatre pieds, soutient une assise et un dossier en polypropylène. Disponible en plusieurs versions et couleurs, même ton sur ton.

SEGIS' HOMMAGE AN CARLO BARTOLI Aus Eisen wird RION NEUGESTALTUNG

Basaglia + Rota Nodari.
Der 2009 von Carlo Bartoli entworfene Stuhl IRON präsentiert sich in einem neuen Gewand. Die Aktualisierung dieses zeitlosen Entwurfs, der von einem Meister des italienischen Designs gestaltet wurde, macht die inneren Werte sichtbar. Basaglia + Rota Nodari beteiligten sich am IRON-Projekt durch einen Neugestaltungsprozess, der einen roten Faden darstellt, der Vergangenheit, Gegenwart und Zukunft eines sich ständig weiterentwickelnden Unternehmens wie Segis vereint. RION ist ein Stuhl mit ausgefallenen Linien, leicht und widerstandsfähig, perfekt für die Welt der Gemeinschaft, er kann zu einem Protagonisten im Gastgewerbe werden. Eine Metallstangen- oder Rohrstruktur, in der vierbeinigen Version, trägt einen Sitz und eine Rückenlehne aus Polypropylen. Es ist in zahlreichen Ausführungen und Farben erhältlich, auch Ton-in-Ton.

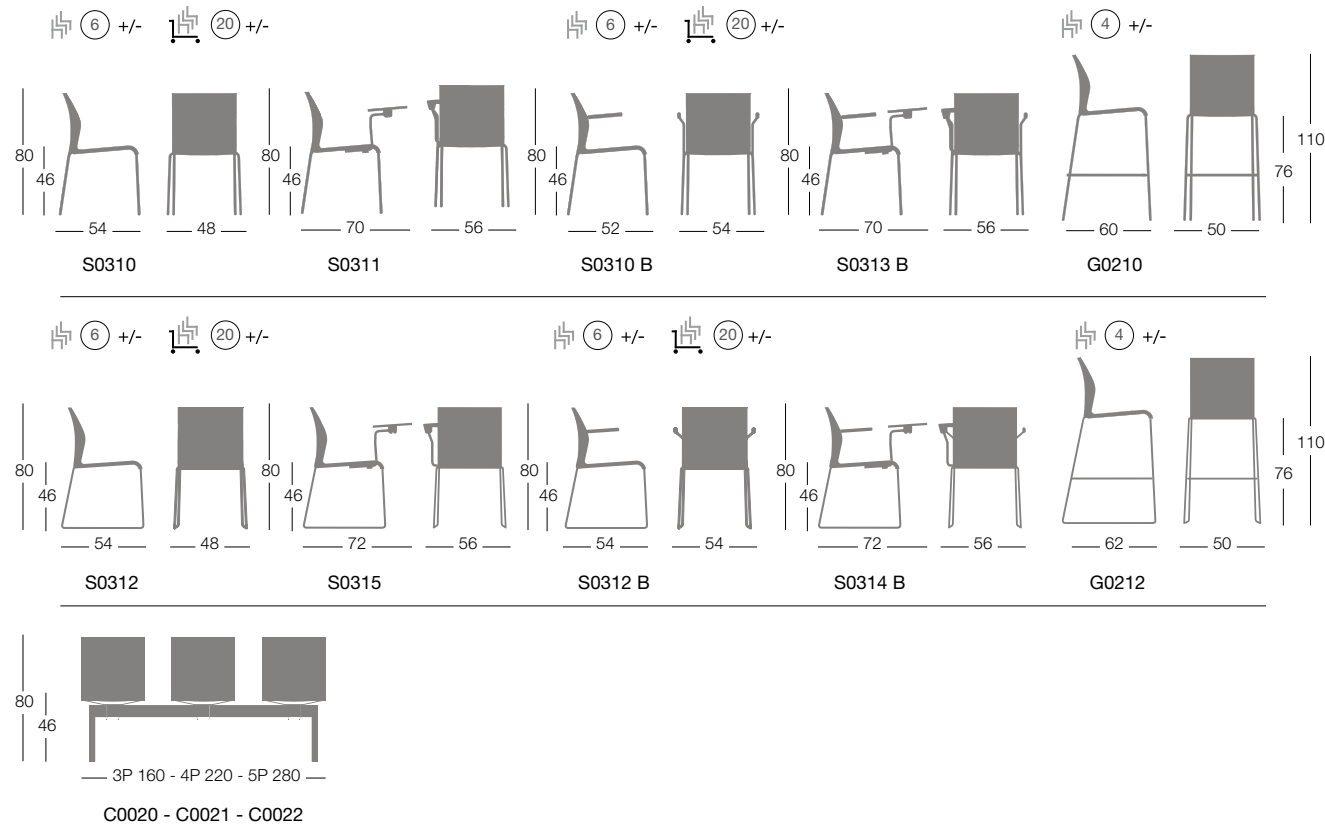

Finiture / Finishes / Finitions / Ausführungen

Polipropilene / Polypropylene / Polypropylène / Polypropylen

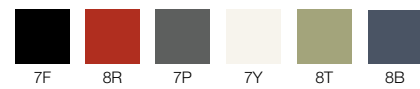

Struttura / Frame / Structure / Gestell

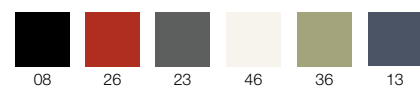

RION

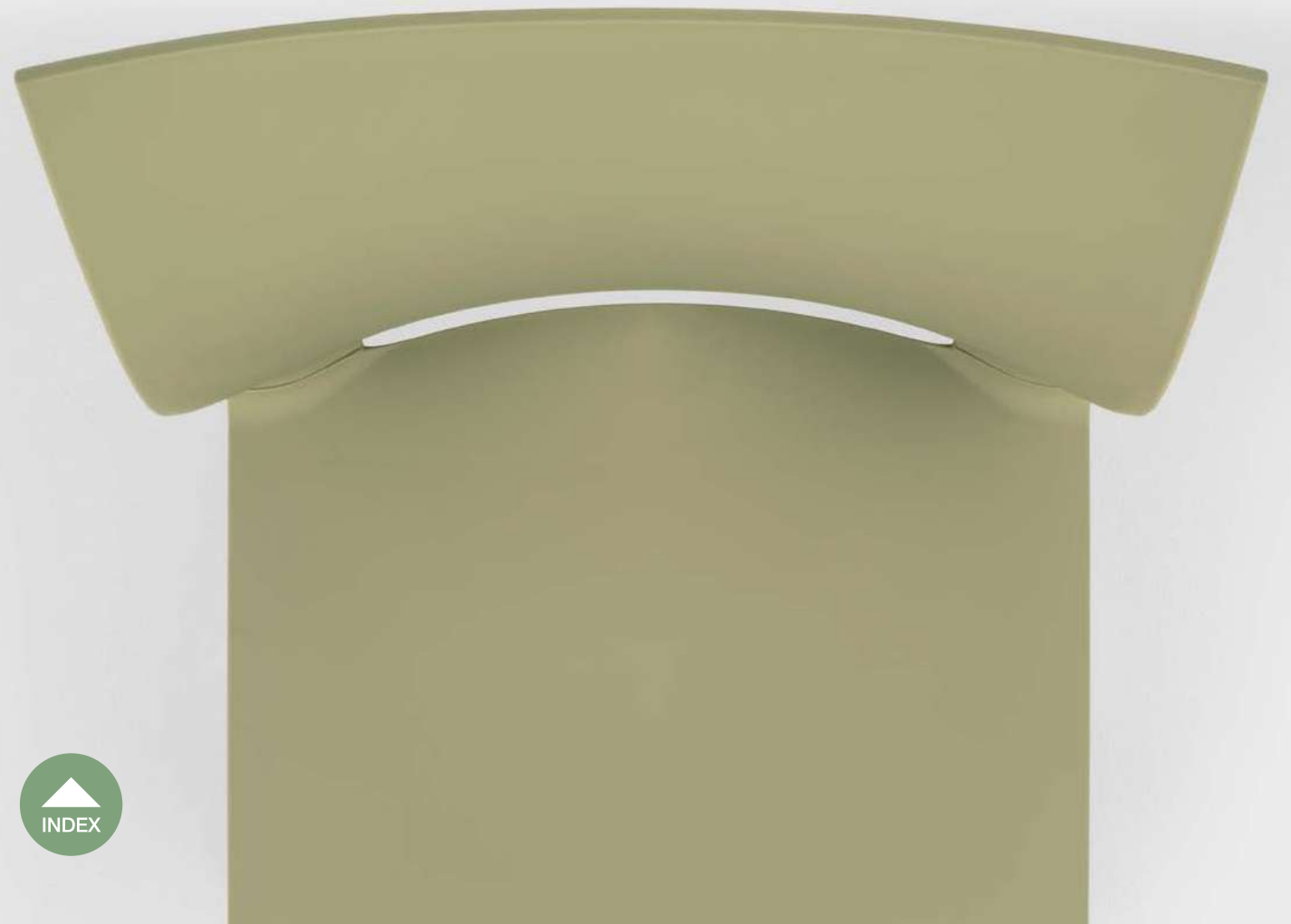
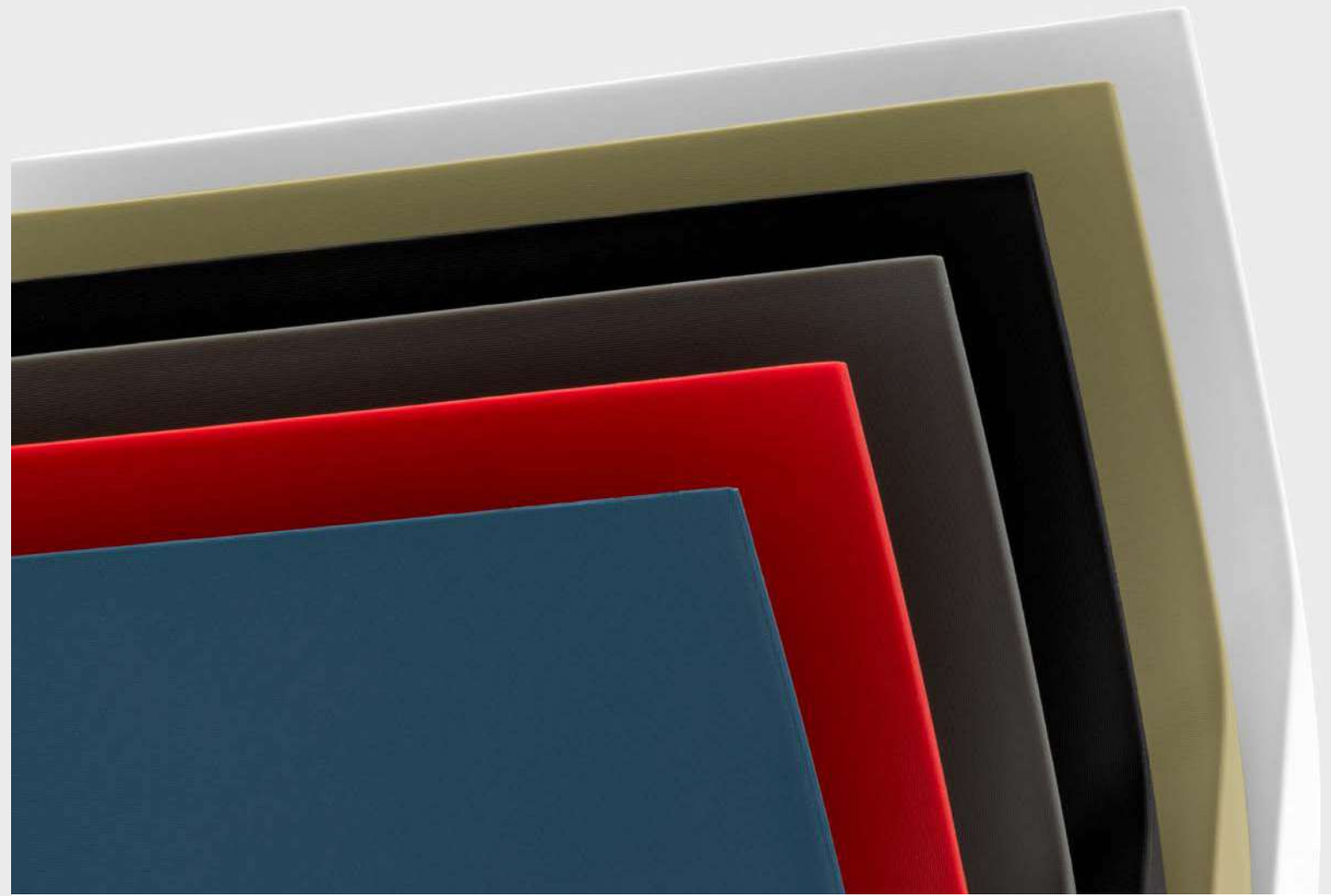

RION













TWIRL

UTS

Creato dal dipartimento Ricerca e Sviluppo di Segis, Twirl rappresenta perfettamente lo stile dell'azienda. Uno sgabello dalla forte personalità, funzionale e disponibile in due altezze. La seduta è in polipropilene stampato, la base è invece disponibile in tondino di acciaio o in legno: perfetto sia per gli ambienti industrial che per quelli dal sapore nordico. È disponibile nei colori verde, blu, rosso, bianco, antracite e nero delle sedute coordinabili con la base in metallo colore su colore. Twirl è uno sgabello che si distingue nei locali ristorante o caffè ed è perfetto nelle zone break di ufficio e coworking.

Created by Segis' Research and Development Department, Twirl perfectly represents the company's style. This functional stool has a strong personality and is available in two heights. The molded polypropylene seat and steel rod or wood base make Twirl perfect for both industrial environments and those with a Nordic flavour. The seats are available in green, blue, red, white, anthracite or black and can be coordinated with the color-on-color metal base. Twirl is a stool that stands out in restaurant or café areas and is perfect in office and coworking break areas.

Créé par le département Recherche et Développement de Segis, Twirl représente parfaitement le style de l'entreprise. Un tabouret avec une forte personnalité, fonctionnel et disponible en deux hauteurs. L'assise est en polypropylène moulé, tandis que la base est disponible en tige d'acier ou en bois: parfait autant les environnements industriels que pour ceux avec une saveur nordique. Twirl est disponible dans les couleurs vert, bleu, rouge, blanc, anthracite et noir des sièges coordonnés à la base en métal ton sur ton. Twirl est un tabouret qui se démarque dans les espaces de restauration ou les cafés et est parfait dans les espaces de bureau et de coworking.

Twirl wurde von der Forschungs- und Entwicklungsabteilung von Segis entwickelt und repräsentiert perfekt den Stil des Unternehmens. Ein funktionaler Hocker mit starker Persönlichkeit, der in zwei Höhen erhältlich ist. Der Sitz besteht aus geformtem Polypropylen. Das Untergestell ist entweder in Stahl oder in Holz erhältlich. Der Hocker ist perfekt für eine industriell geprägte Umgebung und Ambiente mit nordischem Flair geeignet. Die Sitze sind in den Farben grün, blau, rot, weiß, anthrazit und schwarz erhältlich. Das Metallgestell kann farblich mit den Sitzen abgestimmt werden. Twirl ist ein Hocker, der in Restaurant- oder Cafébereichen hervorsteht und sich perfekt für Büro- und Coworking-Pausenbereiche eignet.

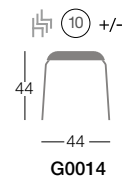

G0014

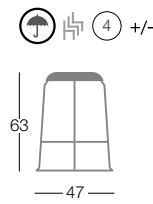

G0012

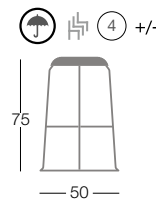

G0013

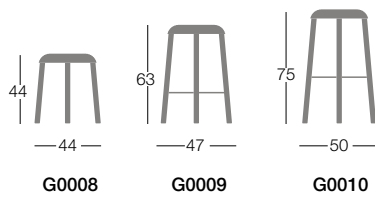

G0008

G0009

G0010

Finiture / Finishes / Finitions / Ausführungen

Polipropilene / Polypropylene / Polypropylène / Polypropylen

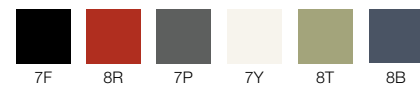

Struttura / Frame / Structure / Gestell

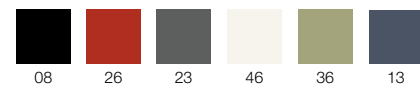

Legno / Wood / Bois / Holz







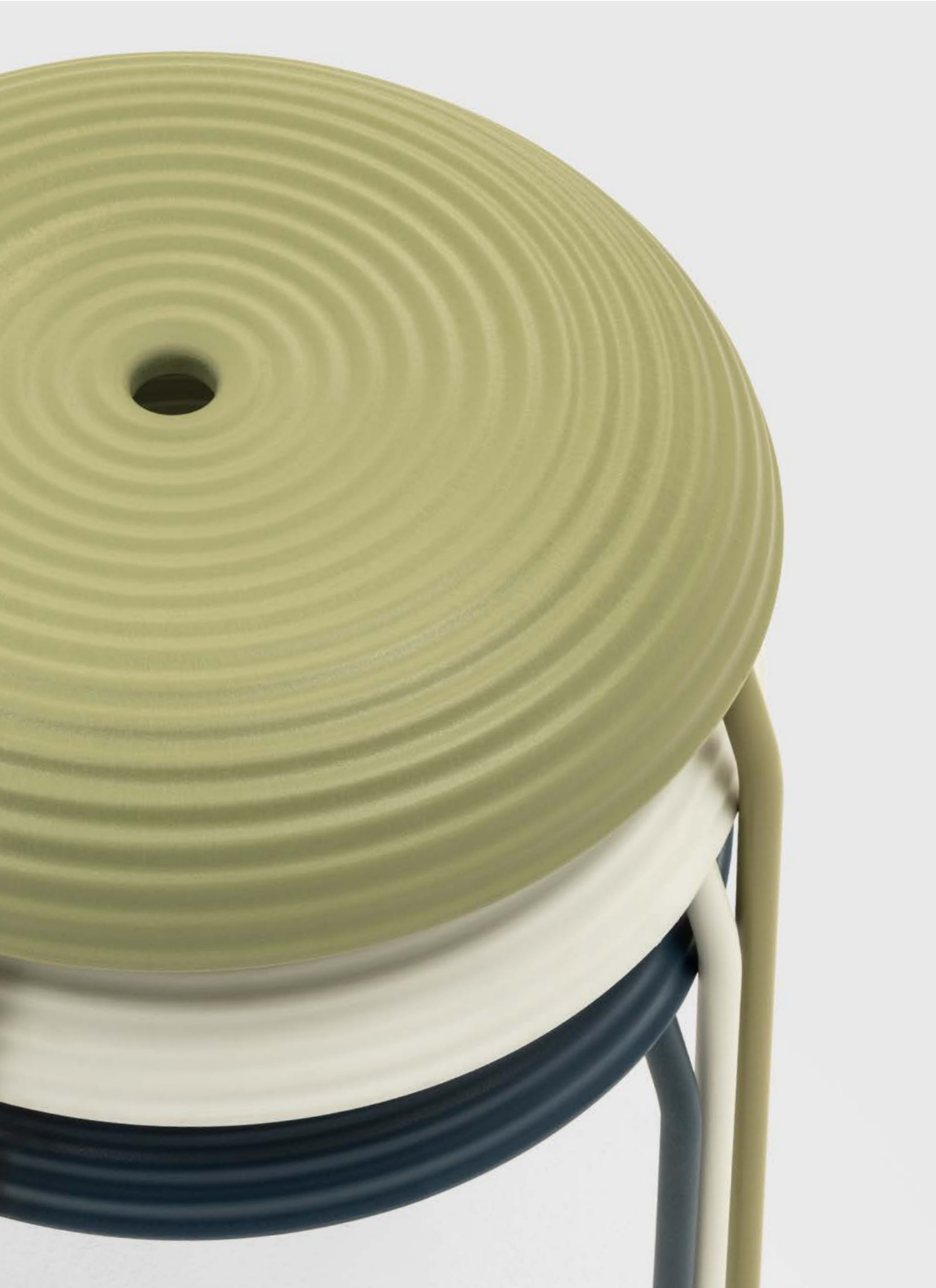

ARTFUL IRON

Massimiliano Mornati

Il tavolo Artful Iron coniuga l'unicità e complessità compositiva di Artful, declinandolo in un'intera collezione di tavoli perfetta per il mondo ufficio. Dalla versione scrivania fino al formato da sala riunioni presidenziale, il tavolo Artful Iron si distingue per l'eleganza la leggerezza del disegno e resistenza. La base è in metallo verniciato e supporta piani in diverse finiture accessoribili con un discreto top access per facilitare il collegamento dei dispositivi elettronici all'impianto elettrico.

The Artful Iron table combines the uniqueness and compositional complexity of Artful, expanding it into an entire collection of tables perfect for the office world. From the desk version to the presidential meeting room format, the Artful Iron table stands out for its elegance, lightness of design and resistance. The powder coated metal base supports tops in different finishes and can be accessorised with a discreet top access to facilitate the connection of electronic devices to the electrical system.

La table Artful Iron allie l'unicité et la complexité de composition d'Artful, en la déclinant dans une collection entière de tables parfaites pour le monde du bureau. De la version bureau au format salle de réunion présidentielle, la table Artful Iron se distingue par son élégance, sa légèreté et sa résistance. La base est en métal peint et supporte les plateaux de différentes finitions qui peuvent être accessorisés par un discret top-access pour faciliter la connexion des appareils électroniques au système électrique.

Der Artful Iron-Tisch verbindet die Einzigartigkeit und kompositorische Komplexität von Artful und erweitert ihn zu einer ganzen Tischkollektion, die perfekt für die Arbeitswelt geeignet ist. Geeignet als Schreibtisch bis zum Konferenztisch für die Geschäftsleitung zeichnet sich der Artful Iron-Tisch durch seine Eleganz, Leichtigkeit im Design und Robustheit aus. Der Sockel ist aus lackiertem Metall und kann mit Tischplatten in verschiedenen Ausführungen, die mit einem diskreten Zugang von oben ausgestattet werden können, um den Anschluss elektronischer Geräte an das elektrische System zu erleichtern, bestückt werden.

* altezza tavolo piano escluso / base height without top / hauteur base hors plateau / Höhe Tischgestell ohne Platte

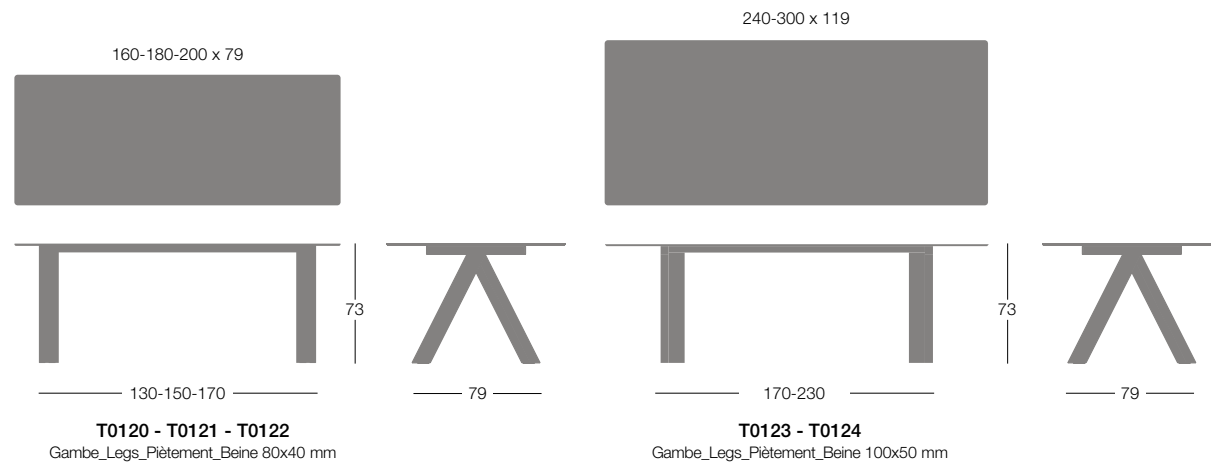
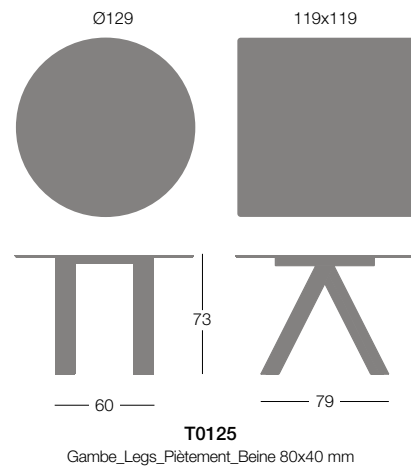

Finiture / Finishes / Finitions / Ausführungen

Struttura / Frame / Structure / Gestell

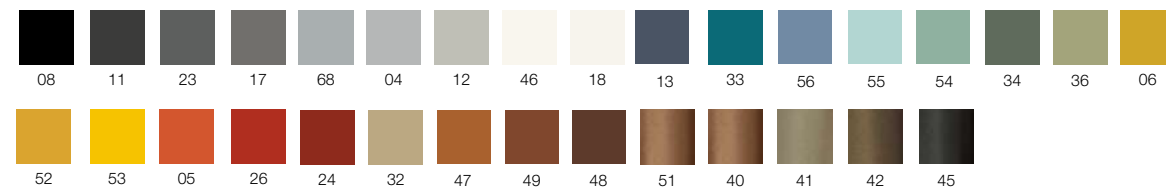



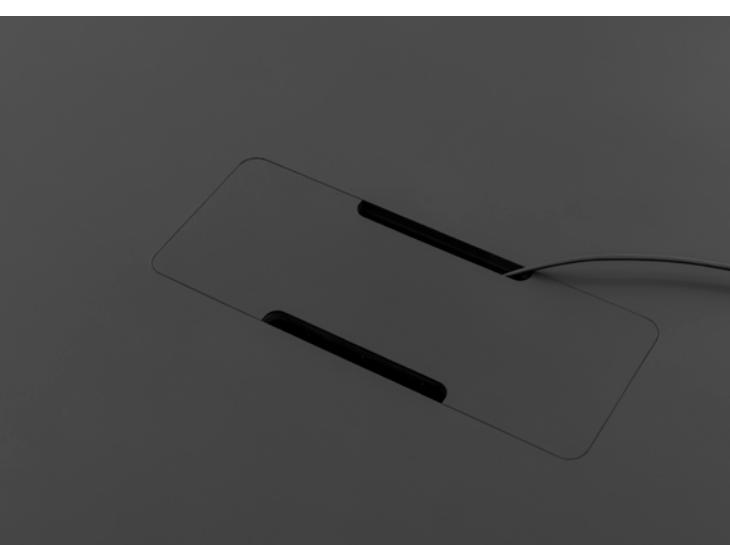
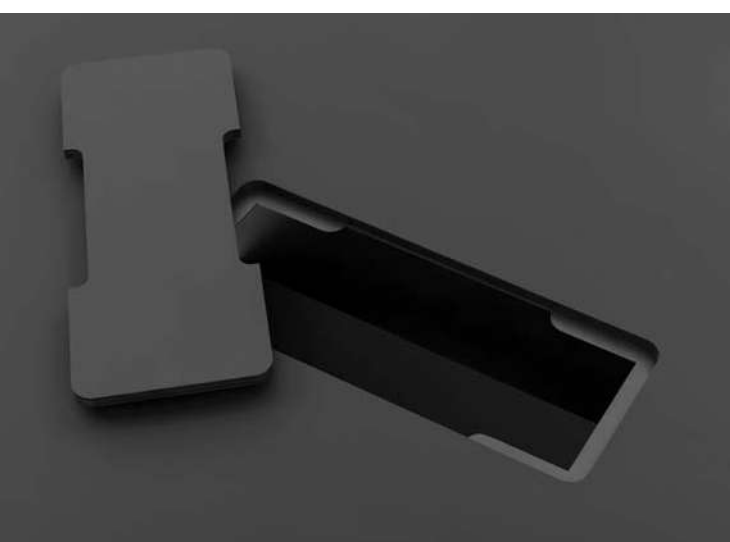
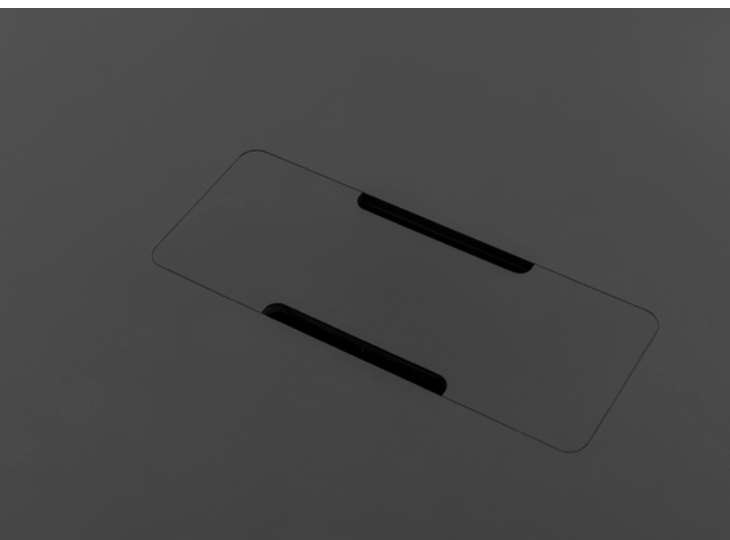



SAMU

Bartoli Design

Sistema di tavoli e tavolini per soddisfare tutte le esigenze in ambiente contract. Modelli diversi si compongono con basi centrali a quattro razze abbinabili a molteplici piani. Il design lineare delle basi, prodotte in tre altezze, è ottenuto con profili in acciaio verniciato a polveri in una gamma di svariati colori per uso interno ed esterno.

Alla collezione di tavoli SAMU si aggiunge la versione a 3 gambe.

System of tables and low tables to meet all needs in the contract environment. Different models with either four-spoke or two-spoke bases can be combined with various tabletops. The linear design of the bases, available in three heights, are made in steel profile powder coated in a range of various colours for inside and outdoor environments.

A three-legged table base complements the SAMU Collection.

Programme de tables, pour répondre à tous les besoins de l'environnement contract ou habitat. Samu a un piètement central à quatre branches à utiliser avec divers types de plateaux. Le design linéaire des bases, se décline en trois hauteurs, est obtenu par un profilé d'acier époxy laqué, dans une variété de différentes couleurs pour l'intérieur ou l'extérieur.

La version 3 piétements complète collection de tables SAMU.

System von Tischen und Beistelltischen, um alle Bedürfnisse im Contract-Bereich zu erfüllen. Verschiedene Modelle fügen sich aus mittigen Basen mit vier Speichen zusammen, die mit unzähligen Platten kombiniert werden können. Das lineare Design der Basen, die in drei Höhen hergestellt werden, wird durch pulverbeschichtete Stahlprofile in einer Reihe von verschiedenen Farben für den Innen- und Außenbereich erreicht.

Die 3-beinige Version wird zur SAMU-Tischkollektion hinzugefügt.

* altezza tavolo piano escluso / base height without top / hauteur base hors plateau / Höhe Tischgestell ohne Platte

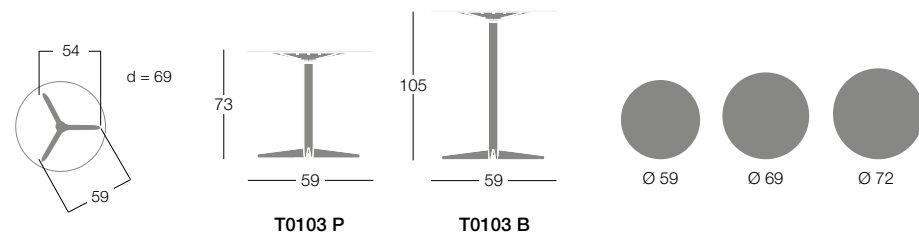

Finiture / Finishes / Finitions / Ausführungen

Struttura / Frame / Structure / Gestell

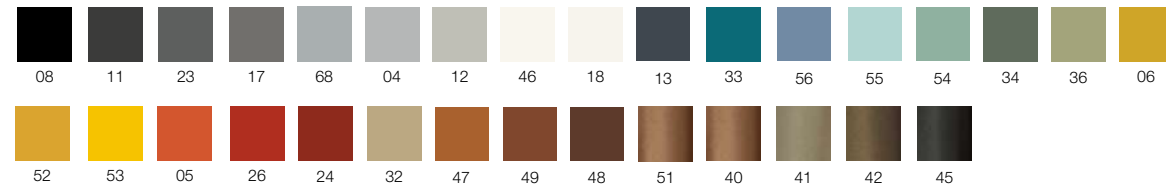

Piani tavolo / Table tops / Plateaux de table / Tischplatten

Nobilitato con bordo ABS / Melamine with ABS edge / Mélaminé avec chants ABS / Melaminplatte mit ABS-Kante (art. PNL)
Spessore / Thickness / Epaisseur / Stärke: 25 mm



Laminato su truciolare bordo ABS / Laminated on chipboard with ABS edge / Stratifié sur aggloméré avec chants ABS
Laminat auf Spanplatte mit ABS-Kante (art. PLT). Spessore / Thickness / Epaisseur / Stärke: 10 mm

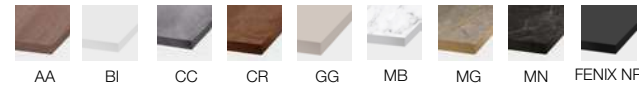

HPL (art. PHP)

Spessore / Thickness / Epaisseur / Stärke: 10 mm



Lamiera verniciata / Powder coated steel / Acier laqué epoxy / Metall Epoxydlackiert (art. PMT)
Spessore / Thickness / Epaisseur / Stärke: 19 mm

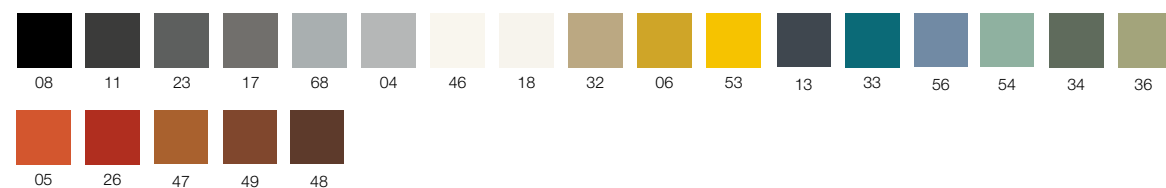

ICONE
ICONS
ICÔNES
IKONEN

E-MOTION

Giancarlo Piretti

Caratterizzata da un movimento di flessione unico nel suo genere, capace di emozionare, è stata pensata e brevettata da Giancarlo Piretti, icona del design italiano. Il progettista è riuscito a trasformare un prodotto tradizionalmente solido e robusto in un'autentica novità tecnologica e stilistica. Una confortevole reinterpretazione della classica sedia in polipropilene stampata con tecnologia air moulding. Disponibile in versione monocolore e bicolore.

This trendy design patented by Giancarlo Piretti, icon of Italian design, transforms the traditionally solid and sturdy back bending movement into an authentic technological and stylistic innovation. A comfortable reinterpretation of the classic chair in polypropylene, injected with the air moulding technology. Available in monochrome or bicoloured finish.

Le mouvement de flexion unique de E-Motion est une expérience hors du commun. Conçue et brevetée par Giancarlo Piretti, personnalité incontournable du design italien, ce produit traditionnellement solide et robuste accède au rang de nouveauté technologique et stylistique. Une réinterprétation confortable de la chaise classique en polypropylène moulé avec la technologie de l'air moulding". Disponible en version unie et bicolore.

E-Motion begeistert durch eine einzigartige Flexion. Entworfen und patentiert von Giancarlo Piretti, Ikone des italienischen Designs, dem es gelungen ist, ein traditionell solides und robustes Produkt in eine echte Innovation zu verwandeln, was Technologie und Stil angeht. Eine komfortable Neuinterpretation des klassischen Stuhls aus Polypropylen in airmoulding Technologie. Erhältlich in einfarbiger und zweifarbiger Ausführung.

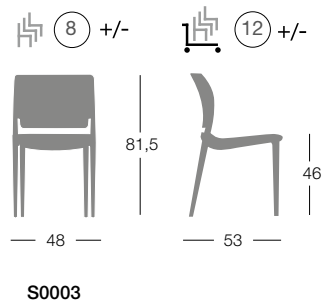

Finiture / Finishes / Finitions / Ausführungen

Struttura-schienale / Frame-back / Structure-dossier / Rücken-gestell

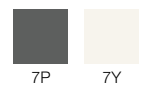

Seduta / Seat / Assise / Sitz





SLIDE

Matteo Thun

Slide reinterpreta e rende attuale una seduta che appartiene alla memoria collettiva. L'applicazione di un materiale moderno, quale il policarbonato, esalta l'essenzialità della struttura in acciaio verniciato, una combinazione che dà vita ad un pezzo dal carattere minimale e raffinato. Esteticamente ricercata ma al contempo pratica, ha un'impugnatura incorporata nel retro dello schienale che permette di maneggiarla con facilità.

Slide exemplifies a chair that belongs to the collective memory and makes it current. With a modern material, such as polycarbonate, it enhances the essentiality of a powder coated steel frame, characterized by its minimal shape and the attention to the details. Aesthetically refined but also practical, Slide has a handle in the back that allows for ease of movement.

Slide réinterprète et réactualise une assise qui appartient à la mémoire collective. En utilisant un matériau moderne, comme le polycarbonate, ce modèle exalte l'essentialité d'une structure époxy laquée. Son design minimaliste ne néglige en rien les détails. Aussi esthétiquement recherché que pratique, Slide a une poignée intégrée à l'arrière du dossier qui permet de la déplacer facilement.

Slide ist die zeitgemässe Neuinterpretation eines Stuhles, der in kollektiver Erinnerung ist. Ein modernes Material, wie Polycarbonat, unterstreicht die Leichtigkeit der Struktur aus oder lackiertem Stahl. Eine minimale Form mit grosser Liebe zum Detail. Ausgesuchte Ästhetik, leicht zu handhaben. Für ein leichtes Handling ermöglicht der Stuhl Slide einen integrierten Griff an der Rückenlehne.

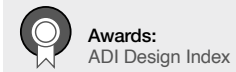
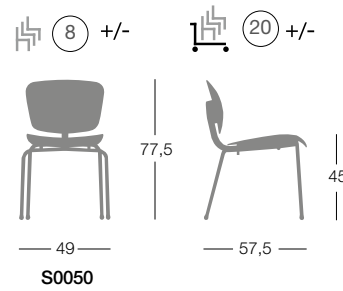

Finiture / Finishes / Finitions / Ausführungen

Struttura / Frame / Structure / Gestell

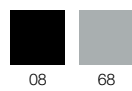

Policarbonato / Polycarbonate / Polycarbonate / Polycarbonat





TRONO

Sottsass Associati

Trono, ironica nel disegno e resistente nella struttura nasce da un progetto di Sottsass Associati. Realizzata in un'unica stampata di tecnopolimeri a forte spessore e adatta anche ai contract più impegnativi, può essere impilata fino a quindici pezzi.

Irony with high thickness. Born from a project of Sottsass Associati Design, it has an ironic design and a resistant structure. Made from a single injection of various technopolymers with a strong thickness, is suitable even for the most exciting situations. Trono is stackable, up to fifteen pieces.

Une fantaisie toute en solidité. Né d'un projet de l'étude Sottsass e Associati, Trono est à la fois amusant dans son design tout en étant résistant dans la structure. Réalisé en une seule injection de technopolymère à forte épaisseur, il est parfaitement indiqué pour un usage intensif. Trono est empilable, jusqu'à quinze pièces.

Ein Ein Stuhl mit doppelter Funktion. Aus dem Studio Sottsass Associati ist er ironisch und zugleich stabil im Design. Aus einem einzigen Spritzguss verschiedener Technopolymeren mit starker Dichte eignet er sich auch für anspruchsvolle Objekteinsätze. Trono ist bis zu fünfzehn Stück stapelbar.

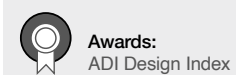
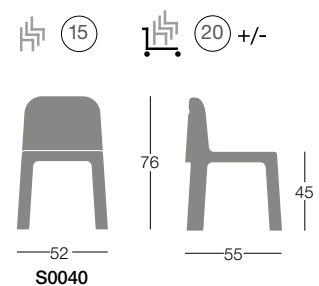

Finiture / Finishes / Finitions / Ausführungen

Policarbonato / Polycarbonate / Polycarbonate / Polycarbonat





UNO

Bartoli Design, Fauciglietti Engineering

Sorprendente e innovativo mix di resistenza e comfort, Uno è il frutto di un preciso equilibrio di materiali, che le ha permesso di aggiudicarsi il XXI Compasso d'Oro. All'interno, una struttura in acciaio assicura la solidità dell'elemento, mentre un tecnopolimero elastico permette una comoda oscillazione dello schienale e una seduta estremamente confortevole.

Inventive, original surprising mix of resistance and comfort, the result of a precise balance of materials, lives in the Uno chair which won the XXI Compasso d'Oro. Inside, a steel frame ensures solidity, while an elastic technopolymer allows a fluctuation of the backrest and comfortable seat.

Mélange surprenant de résistance et de confort, résultat d'un équilibre précis entre les matériaux, la chaise Uno a gagné le XXI Compasso d'Oro. Sa structure en acier assure la solidité, tandis que son technopolymère élastique garantit un basculement confortable du dossier et son confort.

Eine überraschende Mischung aus Beständigkeit und Komfort, Ergebnis einer genauen Balance von Materialien. Dank dieser Tatsache gewann UNO den Compasso d'oro XXI. Das Innenleben aus Stahl sorgt für Stabilität, während sich das flexible Technopolymer dem Körper anpasst und somit ein bequeme.

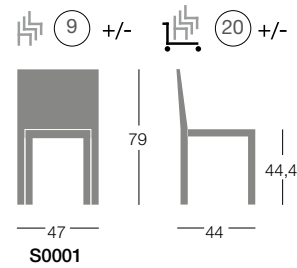

Awards:
Materialica Design Award (2004)
ADI Design Index
XXI Compasso D'Oro ADI (2008)



Finiture / Finishes / Finitions / Ausführungen

Poliuretano / Polyurethane / Polyuréthane / Polyurethan







SEDUTE
SEATING
CHAISES
STÜHLE

BILLA CHAIR

Favaretto & Partners

La nuova seduta nasce come evoluzione spontanea e curata del modello lounge. I medesimi materiali, con il sapore caldo dell'atmosfera nordica, dato dal multistrato, unito all'eleganza del tubo ellittico, disegnano ora nuove proporzioni, a completare una linea capace di essere al tempo stesso originale e di tendenza.

The new Billa Chair is a spontaneous evolution of the lounge model. The same materials, with the Nordic atmosphere given by the warmth of beech plywood combined with the elegance of the elliptical tube, now enhance new proportions to complete a collection both original and trendy.

Ce nouveau siège est né d'une évolution spontanée du modèle lounge. Les mêmes matériaux pour une saveur chaleureuse et l'atmosphère nordique. L'association du multiplis et l'élégance du tube elliptique, créent naturellement une nouvelle proposition d'assise à la fois originale et tendance.

Der neue Sessel ist eine ungezwungene, jedoch gut durchdachte Weiterentwicklung des Modells lounge. Die gleichen Materialien mit einer warmen nordischen Ausstrahlung-dank des Sperrholzes-vereint mit der Eleganz des Ellipsenrohres, schaffen neue Proportionen und vervollständigen eine originelle und gleichzeitig trendige Produktserie.

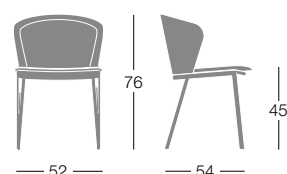

I245

Finiture / Finishes / Finitions / Ausführungen

Struttura / Frame / Structure / Gestell

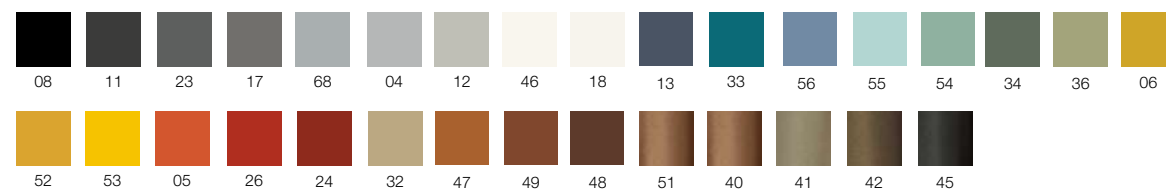

Struttura cromata / Chromed frame / Structure chromée / Gestell Verchromt



02

Legno / Wood / Bois / Holz



RO 02 RO 05





BREEZE

Carlo Bartoli

L'essenziale in forma di sedia. Breeze viene realizzata con il minimo uso di materiali uniti in un'estrema sintesi formale e contrassegnati da elevate prestazioni. L'alluminio, anodizzato o verniciato per la struttura, e il polipropilene riciclabile per la seduta e lo schienale, la rendono perfetta anche per un uso esterno grazie alla sua leggerezza e impilabilità.

Award winning stacking chair with the simplicity of form and function essential for any environment. Aluminum, anodized or powder coated; seat and back in recyclable polypropylene. The chair and stool are perfect for indoor or outdoor.

Breeze est la quintessence de l'assise. Fabriquée avec un minimum de matériaux, ce modèle extrêmement épuré offre une performance structurelle maximale. La structure est en aluminium, anodisé ou époxy laqué, l'assise et le dossier, sont en polypropylène recyclable. Empilable et légère, Breeze est idéale pour une utilisation en extérieur.

Breeze verkörpert das Wesentliche was ein Stuhl bieten kann. Minimalistisch in Verwendung von Materialien in einer starken Formsynthese, mit maximaler Leistung. Struktur aus Aluminium, eloxiert oder lackiert, Sitz und Rücken aus recycelbarem Polypropylen. Perfekt für den Außenbereich, dank seiner Leichtigkeit und Stapelbarkeit.

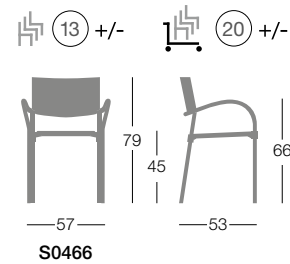

Awards:

2004 / Italy-Selected for the "Coffee Design" collection by the Triennale di Milano Breeze sales reaches 1.000.000 units.

2000 / Italy-Selected for Commemorative Stamp Collection by the Italian Postal Service.

1996 / Germany-Vitra Design Museum. Greece-Thessaloniki Design museum. USA-I.D. Design Distinction Award I.I.D.A. Apex Product Design Ward Germany-High Design Quality Award I.F. Industrie Forum Design Award Red Dot Design Award from Design-Zentrum Nordrhein Westfalen.

Finiture / Finishes / Finitions / Ausführungen

Alluminio verniciato / Powder coated aluminium / Aluminium époxy laqué / Aluminium lackiert

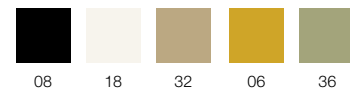

Polipropilene / Polypropylene / Polypropylène / Kunststoff

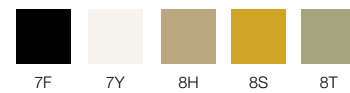

Struttura alluminio anodizzato / Anodized aluminium frame
Structure aluminium anodisé / Aluminium eloxiert Gestell

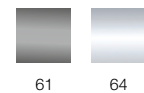



La Cisterna Hotel, San Gimignano, Italy



Arnarbaer Restaurant, Iceland

CAMEL

Bartoli Design

Camel è un sistema di sedute dalle linee morbide e sobrie e dal carattere eclettico, adatto a situazioni diverse. La scocca, in polipropilene, può essere abbinata a differenti basi e accessori, ed è disponibile anche in soluzioni su barra, ideali per sale d'attesa e spazi di transito.

An eclectic collection of seating with delicate soft designed lines, comfortable in a variety of applications. The shell, in polypropylene, is combined with numerous bases and multiple seating for meeting, dining or public waiting environments.

Camel est une gamme de sièges aux lignes douces et sobres, qui s'adaptent à tous les contextes. La coque, en polypropylène, se marie avec un grand nombre de piétements et d'accessoires. Camel peut également être associé avec un système modulable d'assises sur poutre parfait pour les salles d'attente et les lieux de passage.

Camel ist eine Stuhreihe mit weicher und klarer Linienführung, bequem in jeder Situation. Die Schale, aus Polypropylen, kann mit verschiedenen Gestellen und Accessoires kombiniert werden. Verfügbar auch als Bank, Ideal für Wartebereiche und Aufenthaltsräume. Eine vielfältige Serie, für den formellen und auch informellen Einsatzbereich.

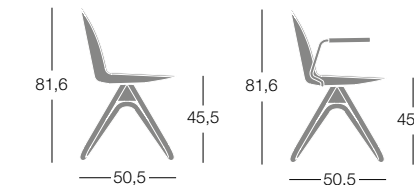
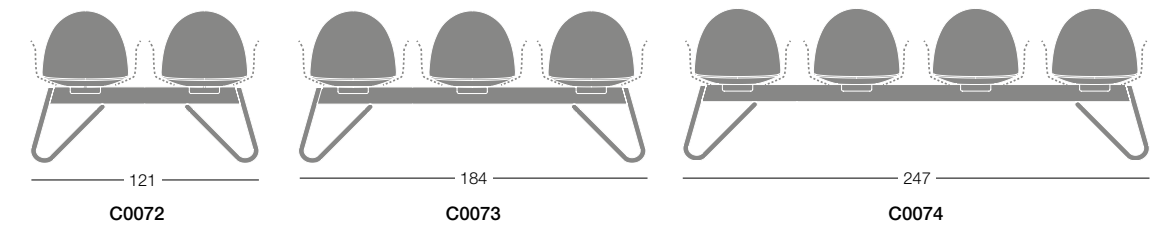
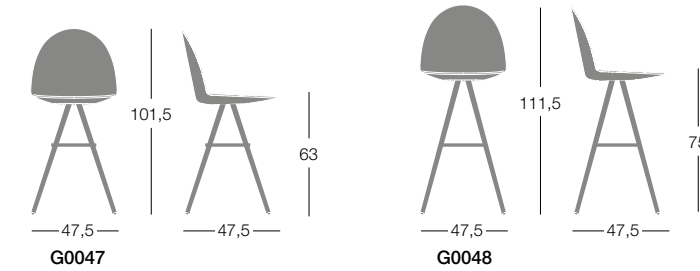
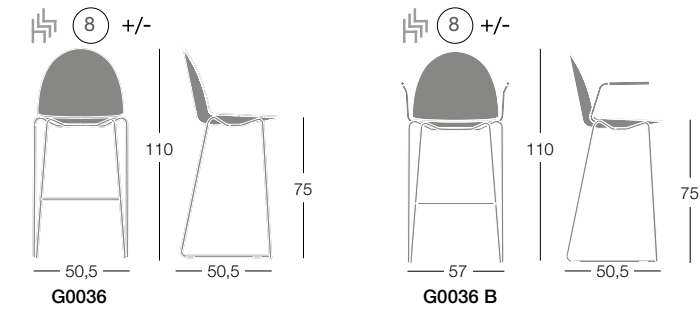
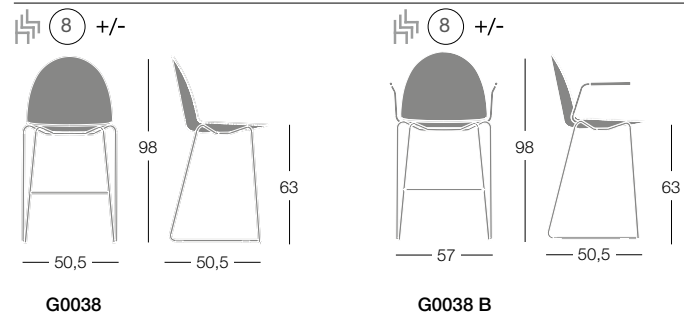
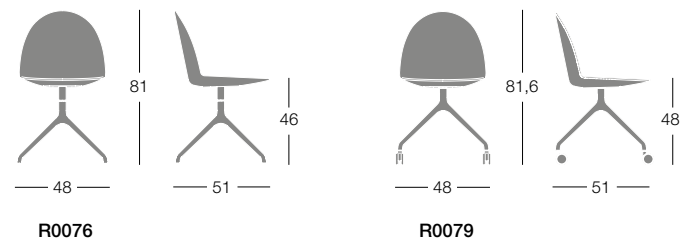
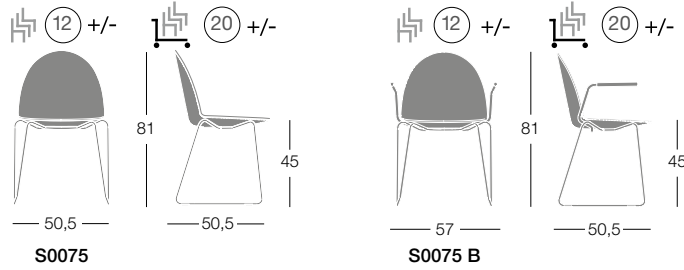
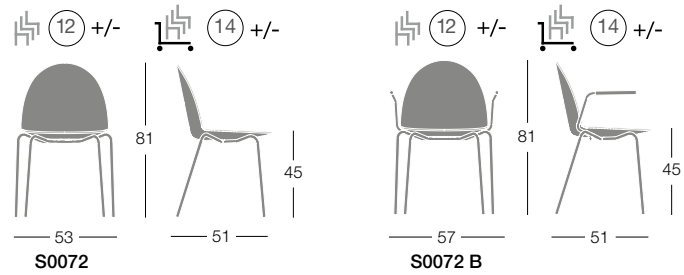
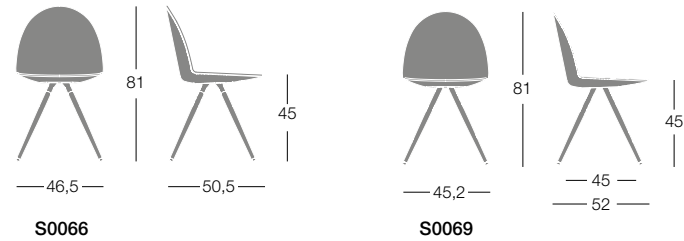

Finiture / Finishes / Finitions / Ausführungen

Polipropilene / Polypropylene / Polypropylène / Kunststoff

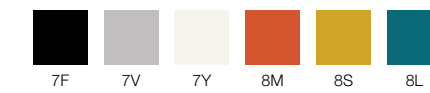

Struttura / Frame / Structure / Gestell

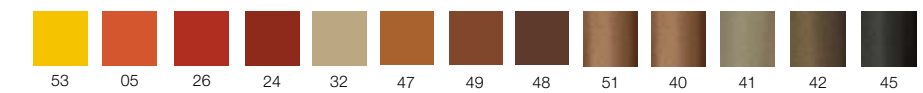
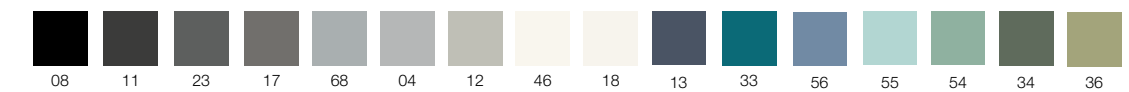

Struttura cromata / Chromed frame / Structure chromée / Gestell Verchromt



Legno / Wood / Bois / Holz

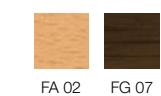





Albert Park College, Liberal Art Centre, Melbourne, Australia





Melbourne University "New Student Precinct" - Melbourne, Australia



Ten Ren Tea Room, Ho Chi Minh City, Vietnam



Urological medical clinic waiting room, Vienna, Austria Peppp-Burzi&Gartenmaier Innenarchitektur und Design OG



CROSSING

Archirivolto Design

Nata dalla combinazione di linee severe sulla scocca e sinuose sull'imbottitura, Crossing è una poltroncina passe-partout dal fascino internazionale, adatta per qualsiasi ambiente. Non solo charme, ma anche praticità grazie a una struttura in metallo, verniciato o cromato, e a una seduta in poliuretano stampato rivestito, a richiesta, in tessuto, pelle o similpelle.

A classic functional club chair for commercial or residential use. The international design is suitable for the most discriminate environment. Available with a powder coated or chromed frame and cold-injected polyurethane foam upholstered in a wide range of materials.

Par la rigueur des lignes de sa structure et les courbes de son rembourrage, Crossing est un bridge versatile au charme international, adaptée à tous les environnements. En plus de son charme fou, sa fonctionnalité grâce à sa structure en métal époxy laqué ou chromé a une assise en polyuréthane moulé qui peut être recouverte de divers matériaux.

Eine strenge Form mit weicher Polsterung, Crossing ist ein Allround Sessel mit internationalem Charme, passend zu jedem Ambiente, nicht nur durch Charme, sondern auch durch ihre Zweckmäßigkeit. Gestell lackiert oder verchromt, Sitz aus geformtem Polyurethan mit verschiedenen Materialien überzogen.

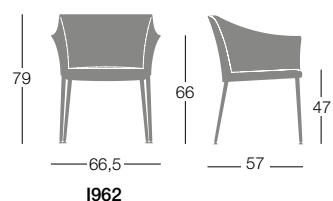

Finiture / Finishes / Finitions / Ausführungen

Struttura / Frame / Structure / Gestell

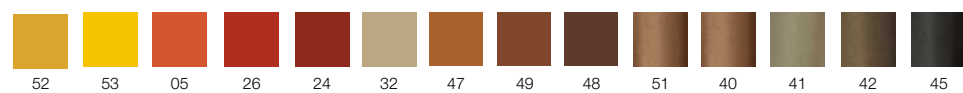

Struttura cromata / Chromed frame / Structure chromée / Gestell Verchromt



02



MCH, Hospital in Tel Aviv, Israel



CULT

Archirivolto Design

Le linee contemporanee della sedia Cult si ispirano all'armonia di un'epoca passata. Forme esili e delicate che danno luogo a un perfetto equilibrio tra i diversi materiali utilizzati, come il metallo e il polipropilene, e l'accurata scelta cromatica, per una finitura monocolore.

Contemporary lines with a vintage touch describe this stacking chair. The delicate and slim design with tapered legs brings a harmony of years past and present. Matching epoxy powder coat and polypropylene colours create a monochromatic finish.

Résolument contemporaine, la chaise Cult est inspirée par l'harmonie d'une époque révolue. Ses formes fines et délicates offrent un équilibre parfait entre les différents matériaux; le métal et le polypropylène avec leur gamme de couleurs soigneusement choisie, pour un rendu monochrome.

Cult, zeitgemäße Linien inspiriert von der Harmonie vergangener Zeiten. Schlanke und zarte Formen, die durch eine perfekte Materialmischung aus Metall und Polypropylen, sowie gekonnt gewählten Farben entstehen.

 Cult is not available for North and South America

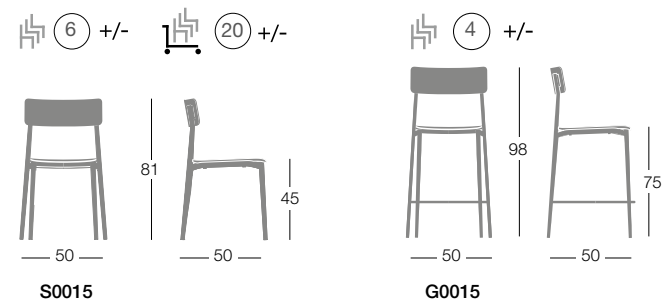

Finiture / Finishes / Finitions / Ausführungen

Polipropilene / Polypropylene / Polypropylène / Polypropylen

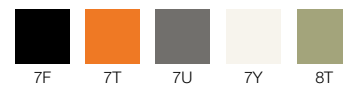

Struttura / Frame / Structure / Gestell

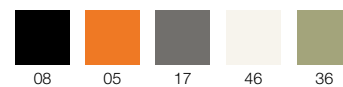



Greenvale Secondary College, Victoria, Australia

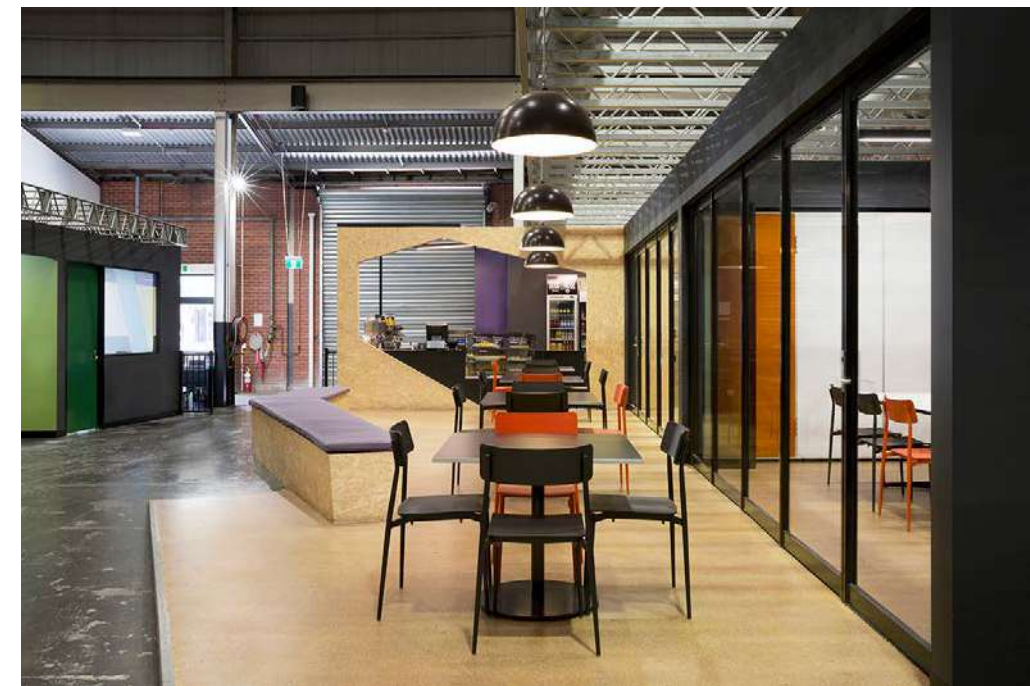

Sleeves Up, Spaces for Idea, Melbourne, Australia





Antica Casa Vinicola Scarpa, Nizza Monferrato, Italy



Ten Ren Tea Room, Ho Chi Minh City, Vietnam

CULT WOOD

Archirivolto Design

La nuova versione in multistrato impiallacciato rovere arricchisce la collezione Cult in polipropilene dando un particolare gusto retro. Struttura in acciaio ad alta resistenza con finitura verniciata a polveri epossidiche, caratterizzata da conifatura alle estremità del tubo.

The new version in oak veneered plywood seat and back adds a retro taste value to the Cult collection in polypropylene. Frame in tapered steel tube in powder coated finish.

La nouvelle version en multiplis contreplaqué de chêne ajoute une valeur au goût rétro à la collection Cult en polypropylène. Structure en pieds coniques en acier à haute résistance en finition époxy laquée.

Die neue Version aus Sperrholz mit Eichenfurnier bereichert die Cult-Kollektion aus Polypropylen und verleiht ihr einen besonderen Retro-Geschmack. Gestell aus konischem, epoxydackiertem Stahlrohr.

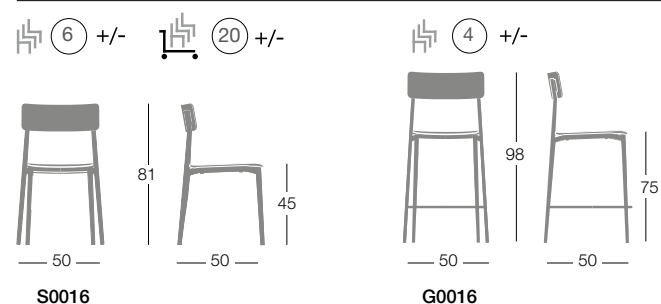

Finiture / Finishes / Finitions / Ausführungen

Legno / Wood / Bois / Holz



Struttura metallo - tappo * / Frame - endcap * /
Structure - bouchon * / Gestell - Endkappe *

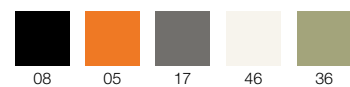

Struttura / Frame / Structure / Gestell

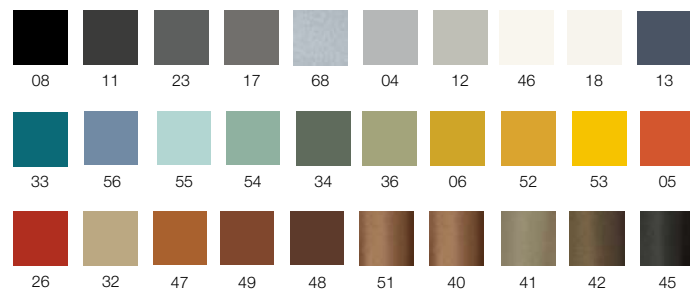

* Tappo / Endcap / Bouchon / Endkappe



* Indicare colore tappo per strutture di colore diverso da:

* Specify the colour of endcap if frame different from:

* Indiquer la couleur du bouchon pour les structures de couleur différente de:

* Bitte geben Sie die Farbe der Endkappe an, wenn der Rahmen von den folgenden Farben abweicht:

08 - 05 - 17 - 46 - 36



DERBY

Archirivolto Design

Derby è una collezione di sedute dallo stile brioso e dinamico, in cui si combinano cromie disponibili in versione mono o bicolore e uno schienale esterno ondulato. A decretare il suo successo nelle soluzioni contract concorrono la molteplice varietà di basi applicabili e la possibilità di disporre di una scocca in poliuretano integrale oppure in poliuretano stampato rivestito in diversi materiali.

Derby is a collection of seating with a cheerful and dynamic style, with a combination of colours available in monochromatic or bicoloured with an external back displaying a raised pattern. To decree its success in contract solutions contribute the variety of applicable bases and the possibility of having a shell in integral polyurethane foam or a cold-injected polyurethane foam upholstered in several materials.

Derby est une collection d'assises au style pétulant et dynamique grâce à son dossier affichant un motif en relief. Disponible dans une combinaison de couleurs monochrome, mais surtout bicolore. La grande variété des piétements et la possibilité d'avoir une coque en mousse de polyuréthane intégrale ou une coque revêtue de différents matériaux a largement contribué à son succès dans l'univers du contract.

Derby, eine Stuhlreihe fröhlich und dynamisch, verfügbar in zweifarbiger oder einfarbiger Ausführung. Die Rückseite der Rückenlehne erinnert an Wellen. Erfolgreich im Objektbereich einsetzbar, dank der Vielfalt der Gestelle und der Möglichkeit die Polyurethanschale auch in gepolstert zu erhalten.

Awards:
2016: USA Winner of 2016 Adex Award for Design Excellence-Platinum Award

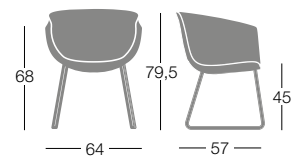

S0090 - I0030

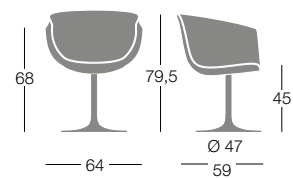

S0092 - I0032

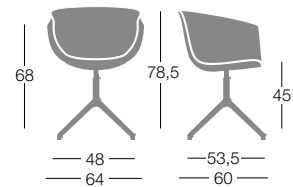

S0097 - I0097

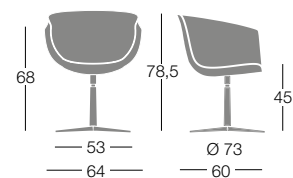

S0094 - I0034

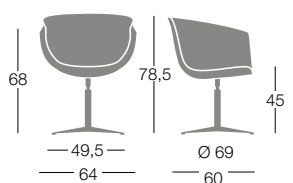

S0095 - I0035

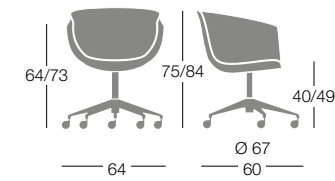

RS0097 - RI0037

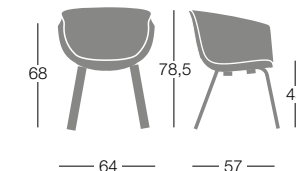

S0098 - I0038

Finiture / Finishes / Finitions / Ausführungen

Struttura / Frame / Structure / Gestell (art. S0090-S0093)

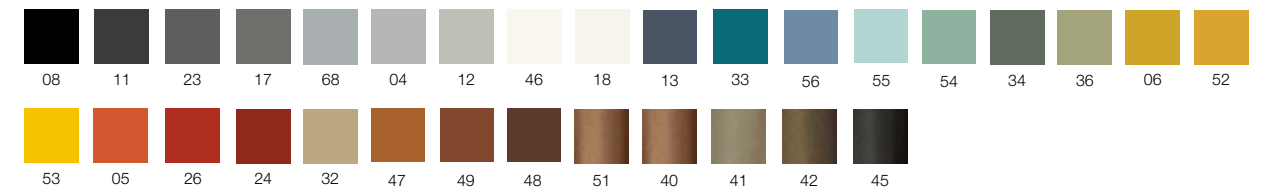

Struttura cromata / Chromed frame / Structure chromée / Gestell Verchromt



art. S0092-S0095-I0032-I0035

art. S0094-RS0097-I0034-RI0037

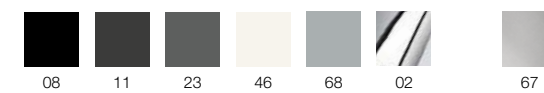

POLIURETANO / POLYURETHANE / POLYURÉTHANE / POLYURETHAN

Scocca monocolore / Monochromatic shell / Coque monochrome / Einfarbige Schale



Scocca bicolore / Bicoloured shell / Coque bicolore / Zweifarbige Schale

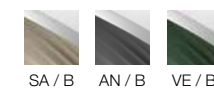

Legno / Wood / Bois / Holz (art. S0098-I0038)

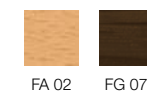



Private House, Ho Chi Minh City, Vietnam



MAZDA dealership, Victoria, Australia



DRAGONFLY

Odo Fioravanti

Dragonfly nasce dall'osservazione del corpo della libellula, caratterizzato da uno sbilanciamento tra le gambe, poste nella parte anteriore del corpo, e la coda che è a sbalzo. Da tale gioco formale scaturisce una sedia in cantilever le cui gambe sono innestate sul fronte mentre la seduta sembra sfidare la forza di gravità. A questa versione si sono aggiunte una serie di basi multifunzione in modo da costruire un vero e proprio sistema di sedute

Dragonfly was born from the likes of the body of a dragonfly which is characterized by an imbalance of weight between the legs at the front and cantilevered tail. This observation inspired seating which thus appears to challenge gravity; the shell's vertical ribbing mimics wings. Multi-functional bases may be paired with a variety of polypropylene shell colours for chairs and stools.

La chaise Dragonfly est née de l'observation de la libellule dont elle porte d'ailleurs le nom. En effet, le corps de la libellule est déséquilibré et semble suspendu dans les airs. En matière de design, le résultat donne une chaise à la structure flottante avec une assise qui semble défier les lois de la gravité. Tout en conservant la même coque, la Dragonfly se décline avec différents types de piétements, afin de constituer une véritable famille de produits capable de répondre à tous les besoins et les utilisations.

Dragonfly ist durch die Beobachtung eines Libellenkokons inspiriert worden. Das Ungleichgewicht zwischen den Vorderbeinen und dem freischwebenden hinteren Teil des Körpers. So entstand dieser Stuhl, ein Freischwinger mit vorderen Beinen und einem Sitz, der die Schwerkraft herauszufordern scheint. Eine Reihe von Gestellen ergänzen die Serie.

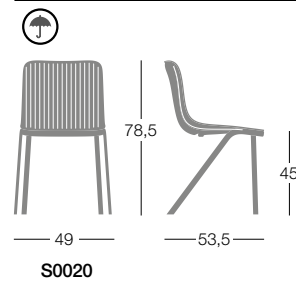

S0020



S0037



G0030



G0040

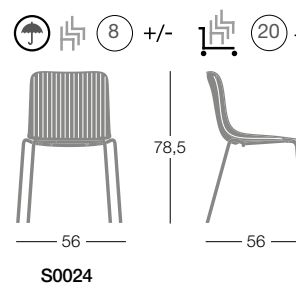

S0024

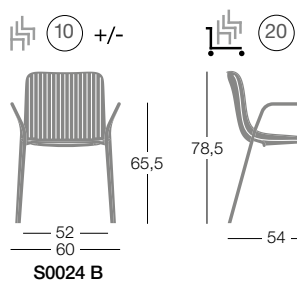

S0024 B

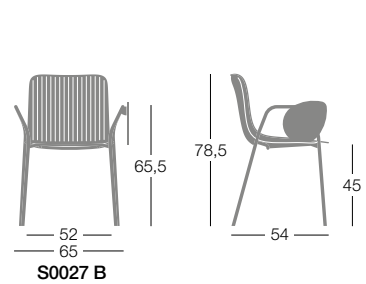

S0027 B

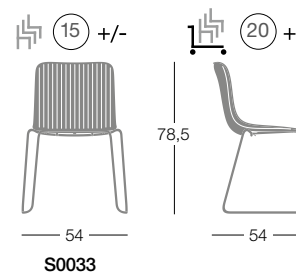

S0033

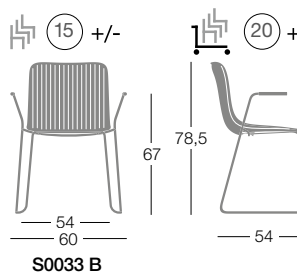

S0033 B



S0033 B



Awards:
2016: Menzione d'Onore al XXIV Compasso d'Oro ADI / Winner at Born Awards in France.
2015: Nominated for "Designs of the Year 2015" London Design's Museum.
2014: exposed at Design Café, Triennale di Milano / Selected from ADI Design Index USA winner of 2014 IIDA/HD Product Award for the Dining Seating Category.
 USA Nominated "Best of Year Awards" for the Seating category: contract / guests

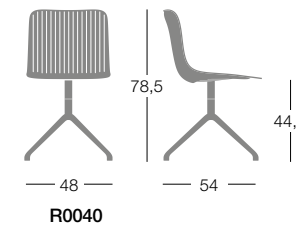

R0040

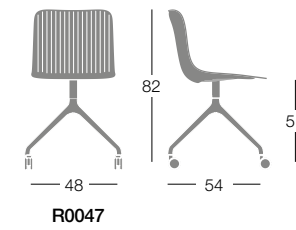

R0047

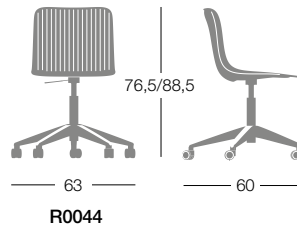

R0044

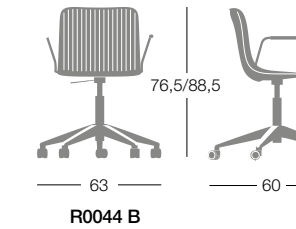

R0044 B

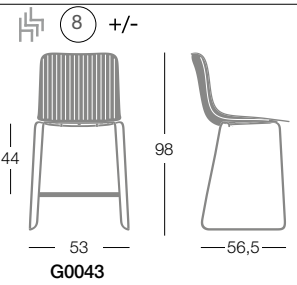

G0043

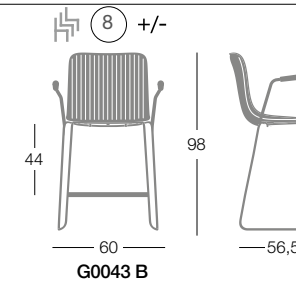

G0043 B

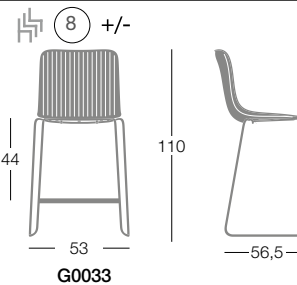

G0033

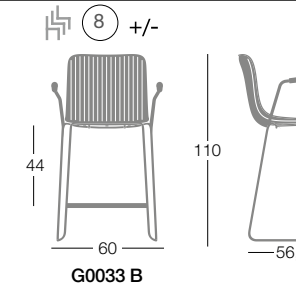

G0033 B

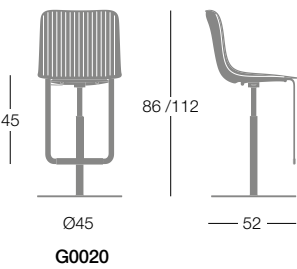

G0020

Finiture / Finishes / Finitions / Ausführungen

Polipropilene / Polypropylene / Polypropylène / Kunststoff

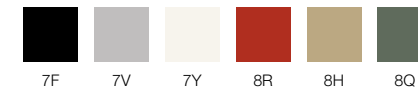

Struttura / Frame / Structure / Gestell

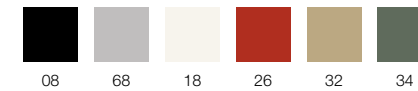

Struttura cromata / Chromed frame / Structure chromée / Gestell Verchromt



Legno / Wood / Bois / Holz
 (art. S0037-G0030-G0040)

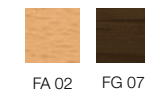



Viterra - Natural Restaurant, Spain





University of Nebraska, Lincoln, NE, Usa



Cobaw Community Health Services, Kyneton, Victoria, Australia



DRAGONFLY





GRACE

Studio Esseci

La seduta avvolgente e la struttura elegante, sono gli elementi che contrassegnano Grace.
La sua scocca in poliuretano stampato, rivestibile in vari materiali, può essere abbinata a diverse basi, dal metallo, alla versione slitta e girevole, al legno massello, offrendo molteplici possibilità di utilizzo.

Adaptable transitional enveloping tub chair with an elegant structure. Solid reliable moulded polyurethane shell upholstered in several materials with three base options: solid beech, steel sled and four star swivel blade in powder coat or chrome finish.

Une assise enveloppante dotée d'une structure élégante, voilà comment décrire parfaitement Grace. La coque en polyuréthane moulée, revêtue de divers matériaux, est proposée avec une grande variété de piètements: en métal, luge et pivotante, ou en bois massif pour un large éventail d'utilisation.

Eine Sitzschale mit einer eleganten Struktur, beschreibt Grace perfekt. Die Polyurethan-Schale kann mit verschiedenen Materialien gepolstert, sowie mit verschiedenen Untergeräten kombiniert werden. Verfügbar in drei unterschiedlichen Gestellvarianten: Kufen- und Drehgestell aus Metall, oder einer Holzversion, bieten vielfältige Verwendungsmöglichkeiten.

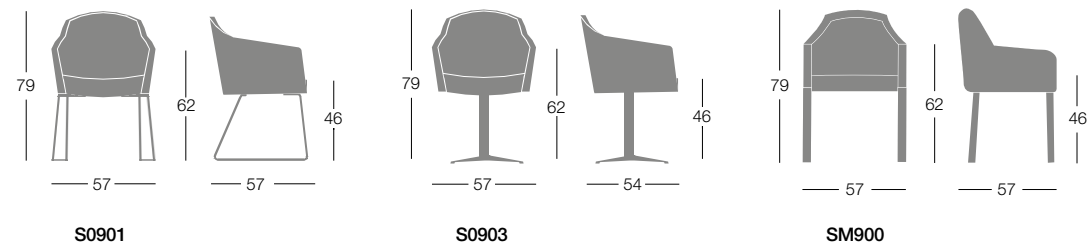

Finiture / Finishes / Finitions / Ausführungen

Struttura / Frame / Structure / Gestell

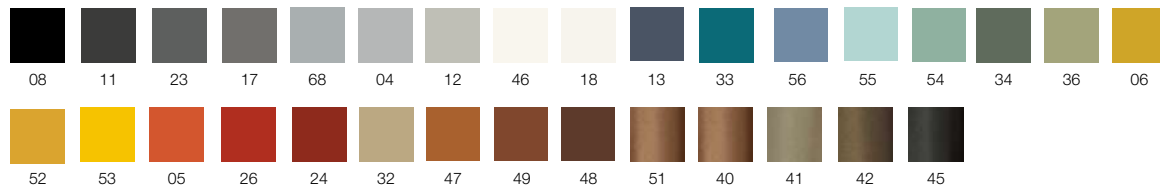

Struttura cromata / Chromed frame / Structure chromée / Gestell Verchromt



Legno / Wood / Bois / Holz (art. SM900)

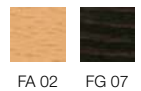





HAMMER-S

Favaretto & Partners

Poltroncina elegante e dalle linee ricercate, è frutto della creatività dello studio Favaretto & Partners. L'abbinamento degli elementi in gioco-l'acciaio del tubolare, il giunto in fusione e il poliuretano stampato-contribuiscono a definire un prodotto di grande pregio. Rivestita in tessuto, pelle o similpelle. Si distingue in ogni ambiente, dalla casa al contract, dalla camera d'albergo alla sala riunioni.

Hammer, elegant and sophisticated, is the result of the creativity of Favaretto & Partners Studio. The combination of the different elements-steel tube, die-cast aluminium element and cold-injected polyurethane foam contribute to define a product of great value. Covered in fabric, leather or faux-leather. Hammer stands out in every contract environment: lobbies, meeting rooms, hotels, and collaborative areas.

La ligne de fauteuils Hammer, élégante et raffinée, est une création du studio Favaretto & Partners. La diversité et la richesse de ses différents composants, l'acier de la structure, la jonction en fonte d'aluminium et le polyuréthane moulé, en font un produit très précieux. Disponible en revêtement tissu, cuir ou simili cuir. Idéale, cette collection s'adapte à tout type d'environnement, du résidentiel au contract, de la chambre d'hôtel à la salle de réunion.

Elegant und anspruchsvoll, das Resultat der Kreativität vom Studio Favaretto&Partners. Die Zusammensetzung verschiedener Elemente, Stahlrohr, Aludruckguss, kaltgepresster Polyurethanschaum, machen hieraus ein wertvolles Produkt. In Stoff, Kunstleder und Leder, passt er in jeden Raum vom Hotel bis hin zu Konferenzzimmer.

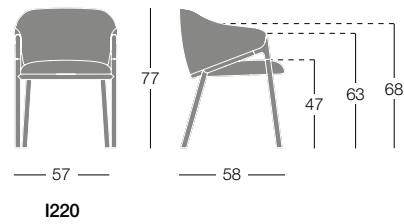

Awards:

2017: Good Design Award by the Chicago Athenaeum for Design Excellence and Innovation
2018: Red Dot Award Product Design
2019: IF Design Award



Finiture / Finishes / Finitions / Ausführungen

Struttura / Frame / Structure / Gestell

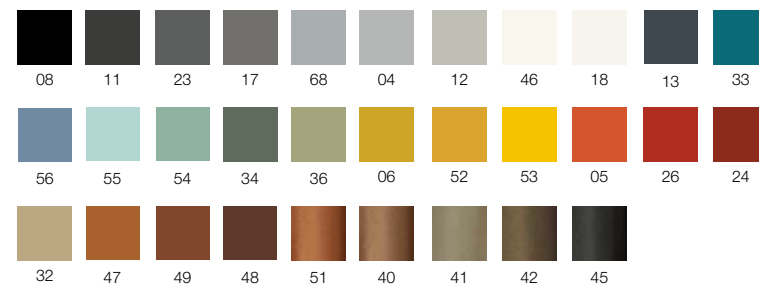

Struttura cromata / Chromed frame / Structure chromée / Gestell Verchromt









NAMI

Paolo Crescenti

Nami offre a chi si accomoda una leggera flessione che, assecondando i movimenti del corpo, garantisce un comfort illimitato. Impilabile, con o senza braccioli, con scocca in polipropilene riciclabile e possibilità di tavoletta scrittoio e aggancio, è ideale per aree conferenze, auditorium, strutture sanitarie, così come per negozi, caffetterie e spazi ricreativi.

Stacking chair with or without armrests, polypropylene shell, with possibility of ganging device and writing tablet. Nami is ideal in training and conference areas, auditoriums, classrooms and healthcare facilities but it is also attractive in a retail setting, cafeteria and recreational space.

Nami offre una légère flexion du dossier qui suit les mouvements du corps pour garantir un confort optimal. Chaise avec ou sans accoudoirs avec coque en polypropylène recyclable, avec système de crochetage et tablette écriteiro rabattable anti-panique. Nami est idéal pour les espaces de conférence, les auditoriums, les établissements de santé, ainsi que pour les magasins, les cafétérias et les espaces de loisirs.

Nami bietet eine leichte Flexion der Sitzschale, die sich der Körperbewegung mit hohem Komfort anpasst. Stuhl oder Hocker mit recycelbaren Polypropylen-Schalen. Verfügbar mit oder ohne Armlehnen, sowie der Möglichkeit einer Reihverbindung und Schreibtischar. Nami ist ideal für Konferenzräume, Auditorien, Gesundheitseinrichtungen, sowie für Geschäfte, Cafeterias und Erholungsräume.

 Nami is produced and distributed by Segis in the following countries: Austria, Germany, Italy, Netherlands, Norway, Spain, Sweden.

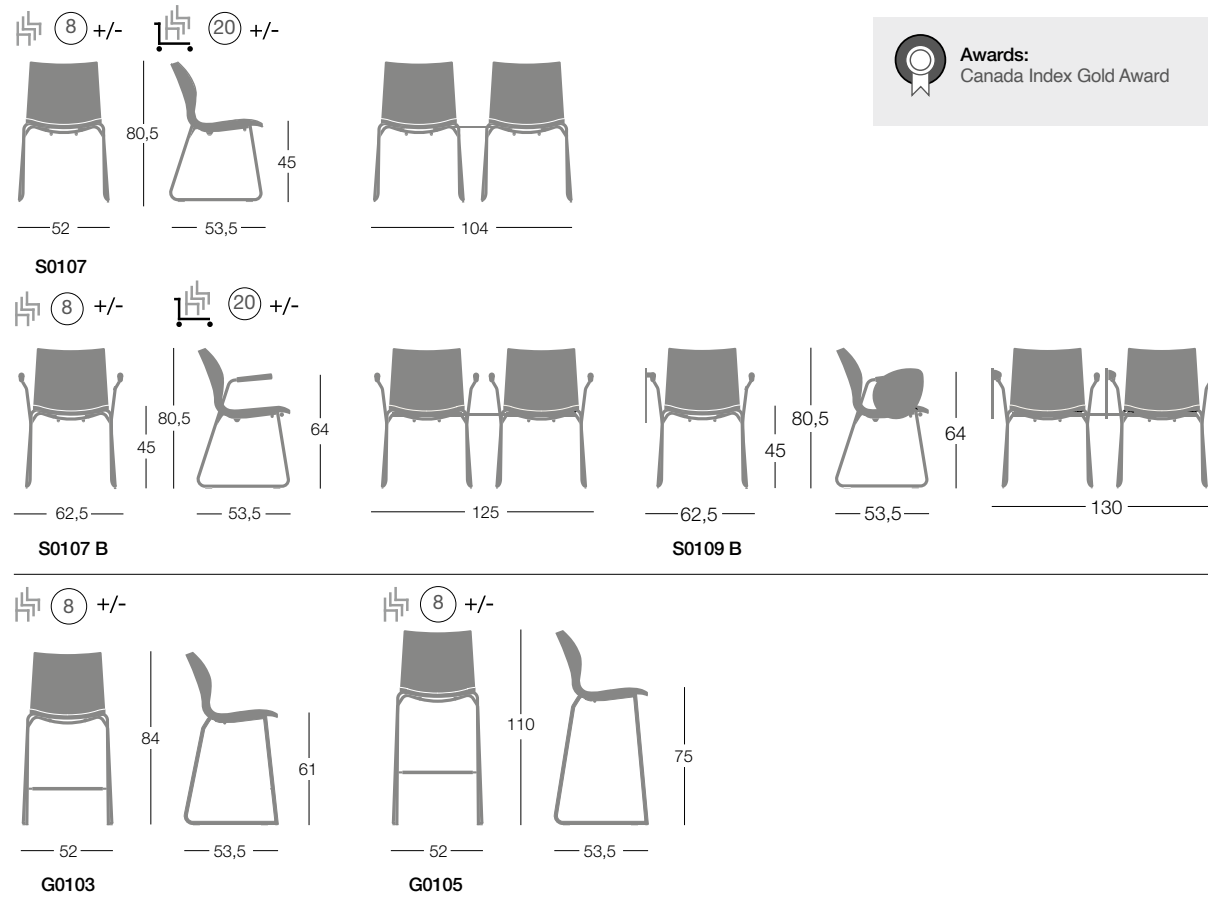

 **Awards:**
Canada Index Gold Award

Finiture / Finishes / Finitions / Ausführungen

Struttura / Frame / Structure / Gestell

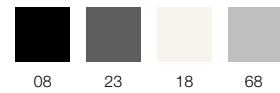

Struttura cromata / Chromed frame / Structure chromée / Gestell Verchromt



Polipropilene / Polypropylene / Polypropylène / Kunststoff

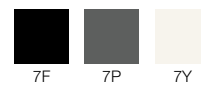



Star of the Sea College Victoria, Brighton, Australia







PACIFIC

George J. Sowden

Pacific si distingue da tutte le altre sedie in polipropilene riciclabile, per almeno due motivi. Il primo è la struttura, realizzata in unica stampata e rinforzata con fibra di vetro, ottimo risultato di una costante ricerca sulle possibilità della tecnologia air moulding. Il secondo risiede nel materiale di stampa che, colorato in massa, consente una finitura superficiale satinata ed esclusiva. Non resta che scegliere tra i vari colori disponibili. È inoltre perfetta per un uso esterno.

Incomparable chair with its durable structure, made with the air moulding technology in one single injection of recyclable polypropylene reinforced with fiberglass. Perfect for indoor or outdoor use available in several colours.

Pacific diffère de toutes les autres chaises en polypropylène recyclable pour au moins deux raisons. Premièrement pour sa structure, réalisée en une seule injection et renforcée avec de la fibre de verre, fruit d'une recherche constante sur les possibilités de la technologie "air-moulding". La deuxième est que le matériel, injecté et coloré dans la masse permet d'obtenir une finition satinée, que vous ne trouverez nulle part ailleurs. Le plus dur sera de choisir entre les différentes coloris disponibles, parfaite également pour l'extérieur.

Pacific hebt sich von allen anderen recycelbaren Polypropylenstühlen aus zwei Gründen ab: der erste ist seine Struktur im Einspritzverfahren, mit Fiberglas verstärkt, das Ergebnis ständiger Air Moulding Technologieforschung. Der zweite Grund ist das Material, welches durchgefärbt ist, und somit einen gewissen Satinlook erhält. Es bleibt nur die Wahl unter den vielen Farben.

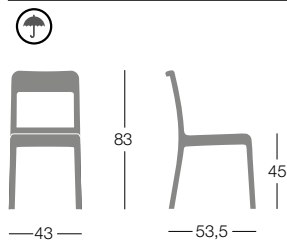

S0500



Awards:

ADI Design Index
2004: Designated as an Environmentally Friendly Product
by Casa Toscana Green home.
Selected for the "Coffee Design" collection by the Triennale di Milano.

Finiture / Finishes / Finitions / Ausführungen

Polipropilene / Polypropylene / Polypropylène / Polypropylen

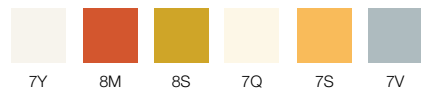

Polipropilene ignifugo / Fire-retardant polypropylene
Polypropylène (PP) non feu / Feuerhemmend





POLO

Archirivolto Design

Seduta dalle linee classiche ma al contempo originali, è realizzata in alluminio fuso ed estruso, successivamente verniciato con polveri epossidiche in svariate tonalità di colore. Ideale per gli ambienti esterni, senza escludere la possibilità di utilizzo in uno spazio interno.

Classic fresh comfortable stacking armchair and non-stacking stool made in die-cast extruded aluminum in a variety of colours. Ideal for indoor or outdoor patios and pool areas.

Véritable objet déco, Polo est un siège en fonte d'aluminium et aluminium extrudé et époxy laqué disponible en différentes nuances de couleur. Idéal pour tout type de contexte que ce soit en intérieur ou en extérieur.

Ein Kunstobjekt als Stuhl. Polo ist aus Aluminiumguss, pulverbeschichtet in verschiedenen Farben. Für den Aussenbereich gedacht, aber auch gut geeignet für den Innenbereich.

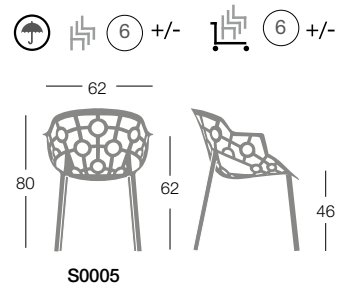

sedute / seating / chaises / Stühle

Finiture / Finishes / Finitions / Ausführungen

Struttura / Frame / Structure / Gestell

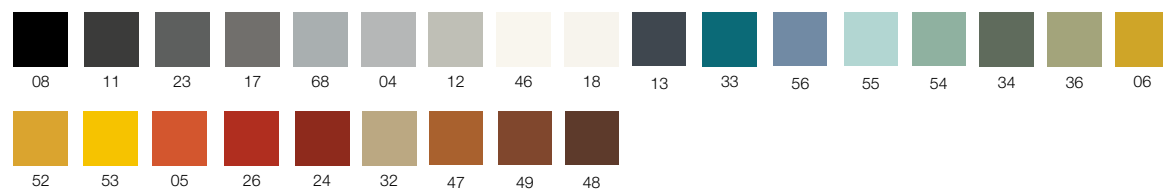





La Leggenda dei Frati, Florence, Italy



POPPYSTAR

Bartoli Design

Sempre brillante, in ogni sua tinta, grazie alla scelta di un materiale che, colorato in massa, consente una particolare finitura satinata. Poppystar, realizzata grazie alla più aggiornata tecnologia air moulding, nasce da un'unica stampata di polipropilene riciclabile, rinforzato con fibra di vetro. Linee morbide e funzionali per ambienti interni ed esterni.

PoppyStar is always bright in every colour thanks to bulk coloration of recyclable polypropylene reinforced with fiberglass; the result is an attractive satin finish. The latest air moulding technology is employed allowing a single injection of the material. This chair is suitable for indoor and outdoor use.

Poppystar brille de mille feux, dans toutes les couleurs, grâce à son matériau coloré dans la masse ce qui permet d'obtenir une finition satinée. Grâce à la dernière technologie d'injection par "air moulding" la structure est réalisée en une seule injection de polypropylène recyclable, renforcée de fibre de verre. Douce touche de couleur à l'intérieur et à l'extérieur.

Glanzvoll dank dem durchgefärbten Material, das hierfür mit einem bestimmten semimattem Finish gewählt wurde. Auch hierfür wurde neueste Air Moulding Technologie im Einspritzverfahren mit Fiberglass eingesetzt. Ein Farbtupfer für den Innen und Aussenbereich.

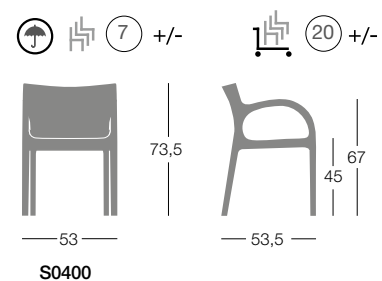

Finiture / Finishes / Finitions / Ausführungen

Polipropilene / Polypropylene / Polypropylène / Kunststoff

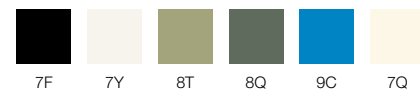

Polipropilene ignifugo / Fire-retardant polypropylene / Polypropylène (PP) non feu / Feuerhemmend



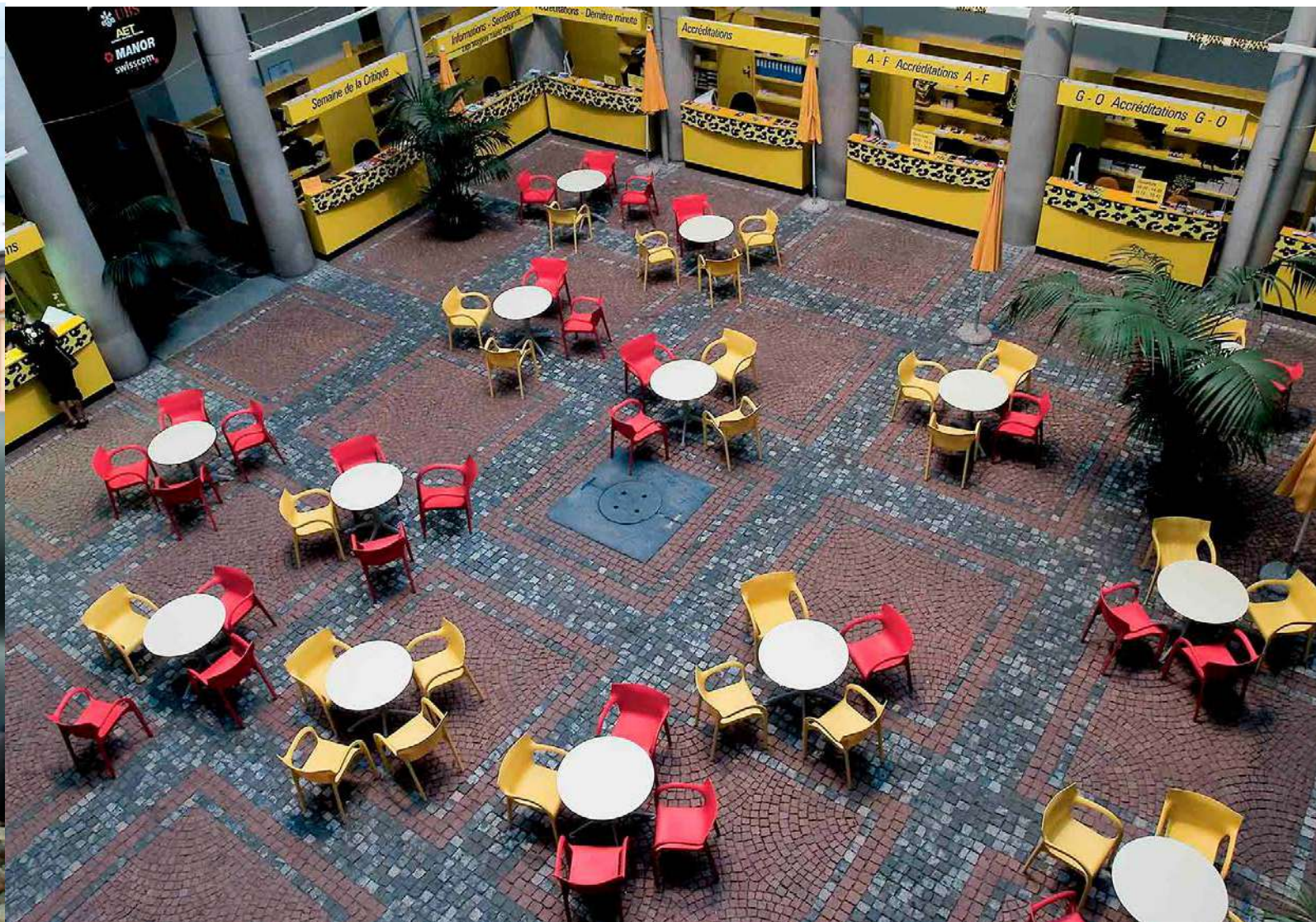

Locarno Film Festival, Switzerland







STAMP

Alejandro Valdés

Con il suo carattere pacato, lieve e discreto, la Stamp Collection porta un'aria di diversificazione, autenticità e originalità al design di architettura e interni. La collezione comprende una serie completa di sedute imbottite: sedie, poltrone e sgabelli che si integrano naturalmente in ambienti pubblici, professionali e residenziali. Elementi senza tempo, contemporanei e dalle linee pulite, che pervadono di un mood sofisticato i luoghi che occupano. Creando leggerezza visiva. La silhouette sobria ed elegante avvolge un interno raffinato con un'imbottitura morbida che invita il corpo al relax e spinge la mente all'azione. Le conversazioni scorrono racchiuse nella fusione di estetica e comfort. Più versatilità con meno materiali. Nella Stamp Collection la cura per i dettagli spazia dal design dello schienale e del sedile alla gamma di strutture, braccioli, accessori e finiture. Tutto attentamente studiato per minimizzare l'uso dei materiali senza compromettere l'alta qualità e la delicata bellezza dell'oggetto. Riduzione dell'impatto ambientale, in linea con la filosofia e la politica gestionale di Segis ottenendo negli anni una serie di certificazioni. Pezzi d'arredamento che ispirano serenità, una serenità che rivela il carattere del prodotto.

With a serene, light and subtle character, the Stamp collection brings an air of differentiation, authenticity and originality to architectural and interior design projects. The collection is a complete family of upholstered seats, composed of chairs, armchairs and stools that blend in naturally in public, professional and residential surroundings. Clean-lined, contemporary and timeless pieces that infuse a sophisticated mood in the places they inhabit. Creating visual levity. Its elegant and austere outline embraces an elaborate interior with a soft upholstery that invites the body to relax and put the mind to work. Conversations flow wrapped in the fusion of aesthetics and comfort. Greater versatility using fewer materials. The attention to detail in the Stamp collection expands from the design of its backrest and seat to its variety of legs, armrests, accessories and finishes, carefully considered to minimize the use of materials without compromising the high quality and gentle beauty of the object. Reduced environmental impact, in keeping with Segis' philosophy and management policy, as holders of a long list of certifications obtained over the years. Pieces that inspire serenity, a serenity that reveals character.

Avec son caractère serein, léger et subtil, la collection Stamp confère distinction, authenticité et originalité aux projets d'architecture et d'aménagement intérieur. La collection est une famille complète de sièges rembourrés, comprenant chaises, fauteuils et tabourets, qui trouvent tout naturellement leur place dans les environnements publics, professionnels et résidentiels. Des pièces aux lignes épurées, contemporaines et atemporelles qui créent une ambiance sophistiquée dans les lieux qu'ils habitent. Des objets qui suscitent une grande légèreté visuelle. Leurs lignes élégantes et austères embrassent un intérieur élaboré avec un rembourrage doux qui invite le corps à se détendre et l'esprit à se mettre au travail. Les conversations fluent naturellement dans un espace où esthétique et confort fusionnent. Une plus grande polyvalence en utilisant moins de ressources. Dans la collection Stamp, le soin du détail va de la conception du dossier et de l'assise, jusqu'aux piètements, accoudoirs, accessoires et finitions extrêmement variés, choisis avec attention en vue de limiter l'utilisation des matières, sans jamais compromettre la qualité et la beauté pure de l'objet. Un impact environnemental réduit, en accord avec la philosophie et la politique de gestion de Segis qui, année après année, a obtenu de nombreuses certifications. Des pièces qui inspirent la sérénité; une sérénité qui donne le ton.

Mit ruhigem, leichtem und subtilem zartem Charakter verleiht die Stamp Collection Architektur- und Innenarchitekturprojekten Differenziertheit, Authentizität und Originalität. Stamp ist eine umfassende Kollektion gepolsterter Sitzgelegenheiten, die sich auf natürliche Weise in öffentliche Bereiche, Arbeitsräume und Wohnbereiche einfügen. Gerade Design, aktuell und zeitlos sorgen die Stühle, Sessel und Hocker der Stamp Collection für exklusive Atmosphäre. Visuelle Leichtigkeit. Die eleganten und einfacher Möbel mit weicher Polsterung laden den Körper zur Entspannung und den Geist zur Aktivität ein. Die Verschmelzung von Ästhetik und Komfort fördert den Gedankenaustausch. Mehr Vielseitigkeit durch bewusste Entscheidungen. Stamp ist Liebe zum Detail. Dies gilt für die Gestaltung von Rückenlehnen und Sitzschalen genauso wie für die große Auswahl an Beinen, Armlehne, Zubehörteilen und Ausführungen. Der bewusste Umgang mit Materialien gewährleistet hohe Qualität und sanfte Schönheit des Objekts. Umweltfreundlichkeit ein grundlegender Aspekt der Philosophie und Managementpolitik von Segis. Beleg dafür sind die zahlreichen, im Lauf der Jahre errungenen Zulassungen. Sitzgelegenheiten die Gelassenheit und Charakter vermitteln.

④ +/- ⑨ +/-

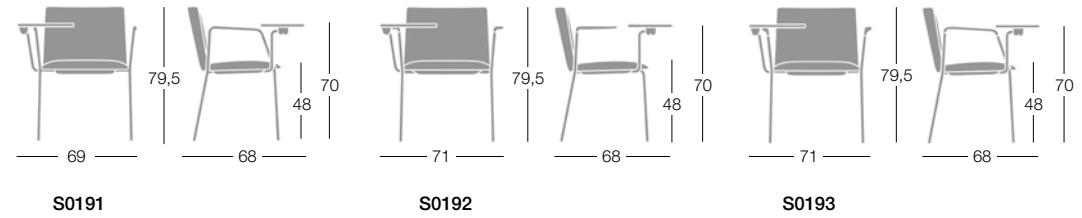

④ +/- ⑫ +/-

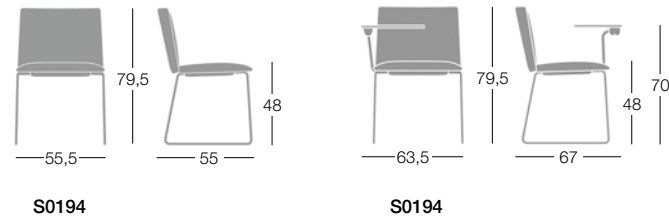

④ +/- ⑫ +/-

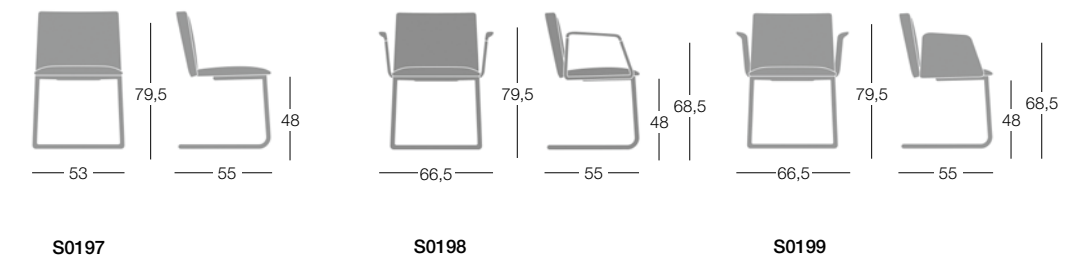
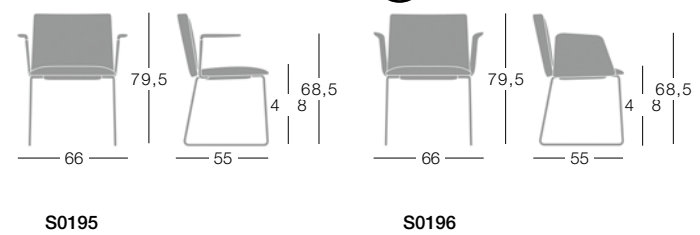

④ +/- ⑫ +/-

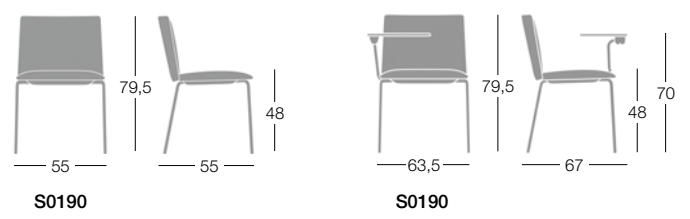

④ +/- ⑨ +/- ④ +/- ⑫ +/- ④ +/- ⑦ +/-

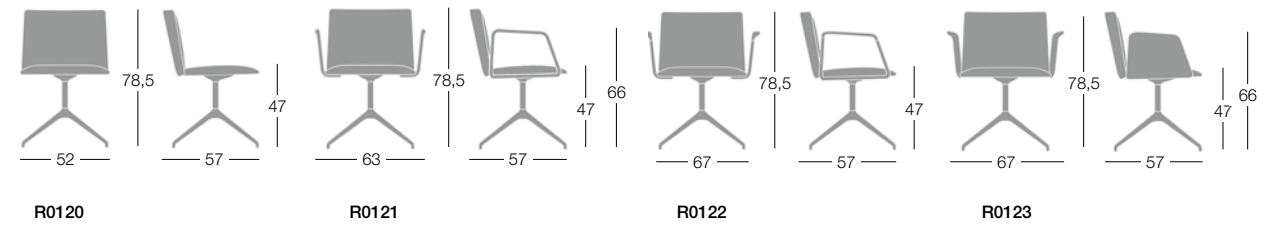
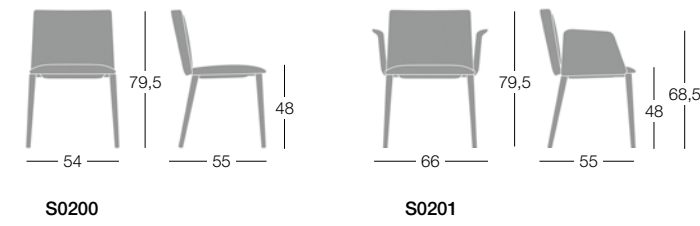
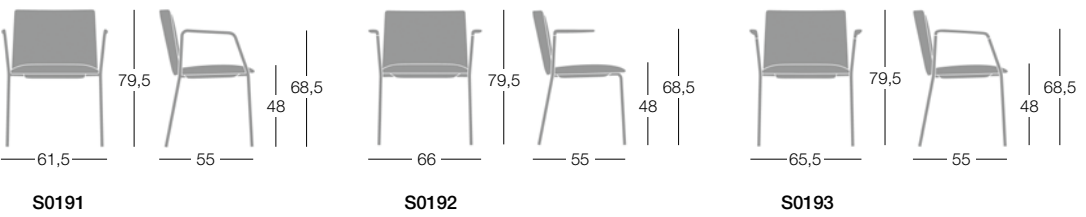

sedute / seating / chaises / Stühle

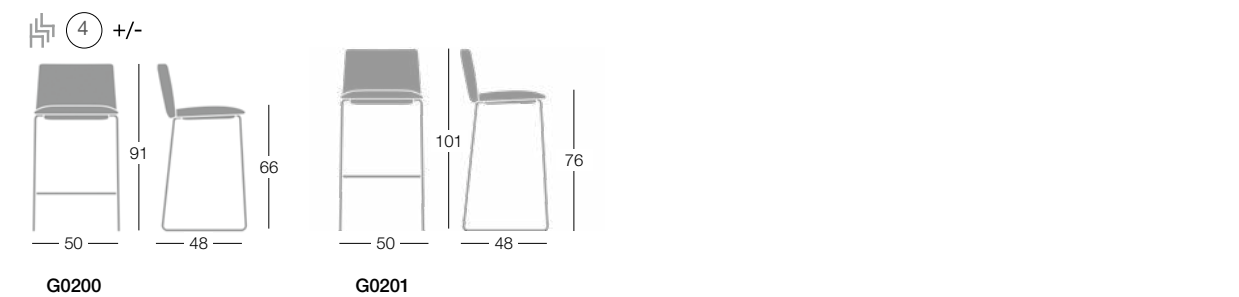
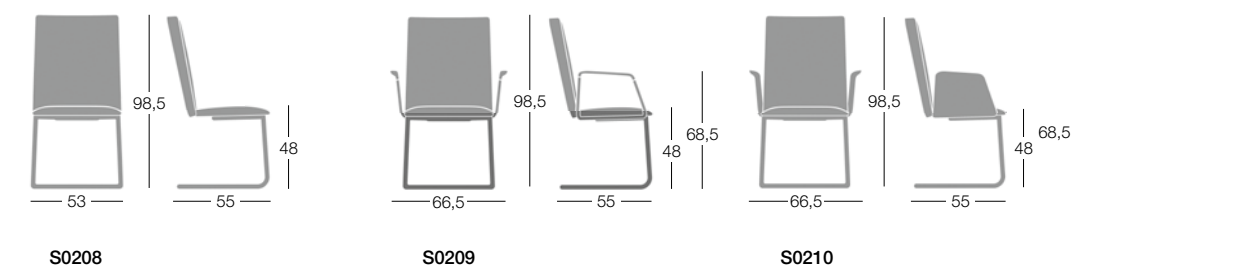
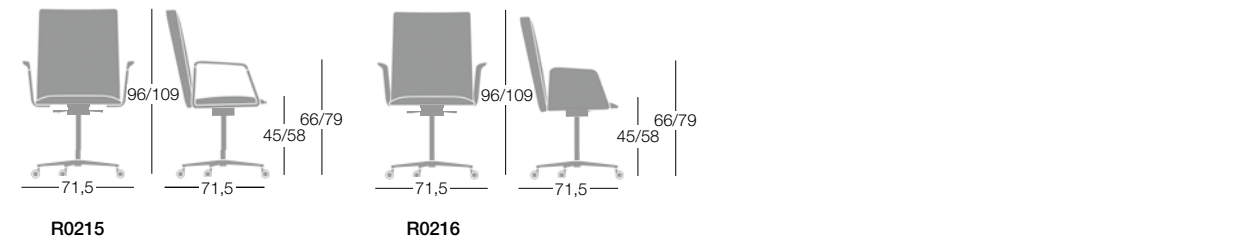
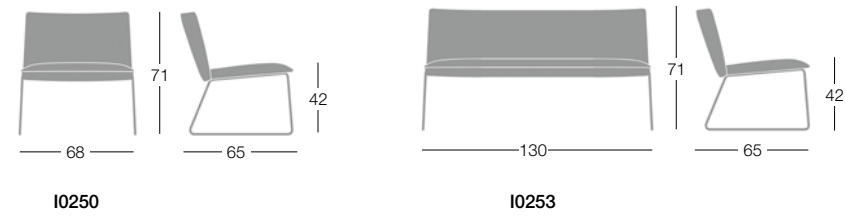
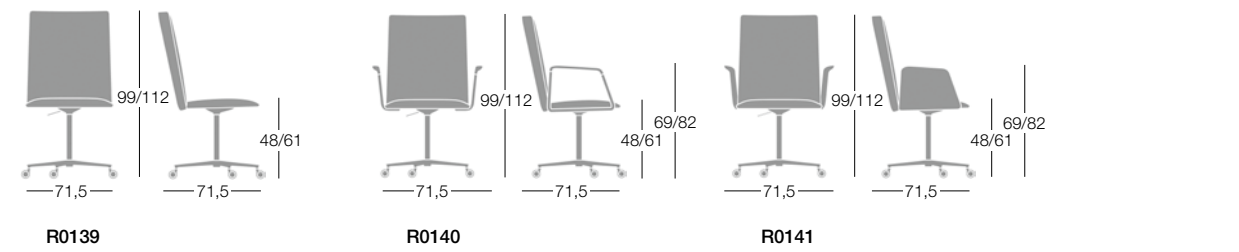
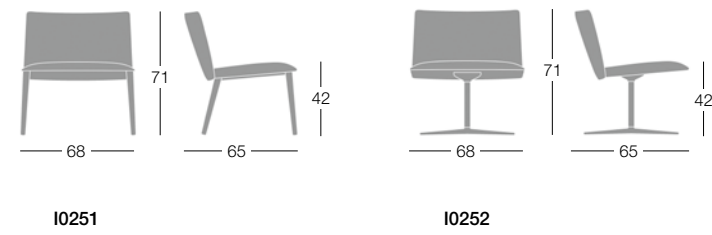
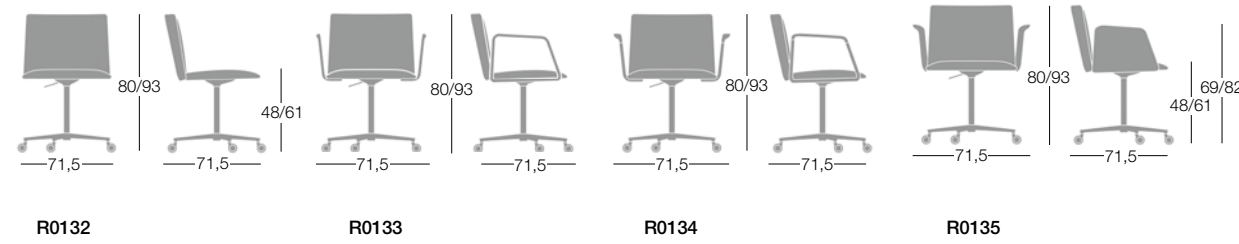
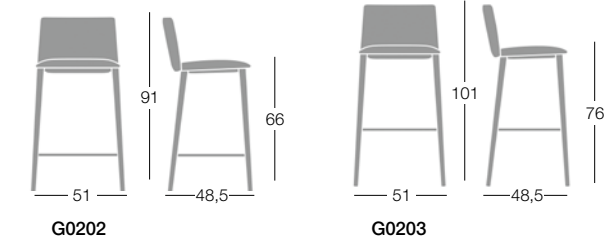
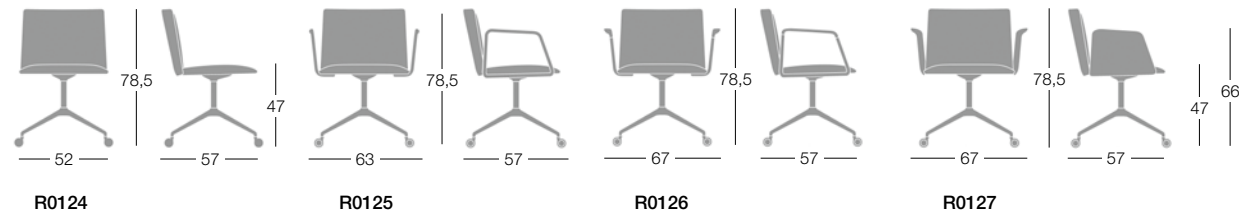

Finiture / Finishes / Finitions / Ausführungen

Struttura / Frame / Structure / Gestell

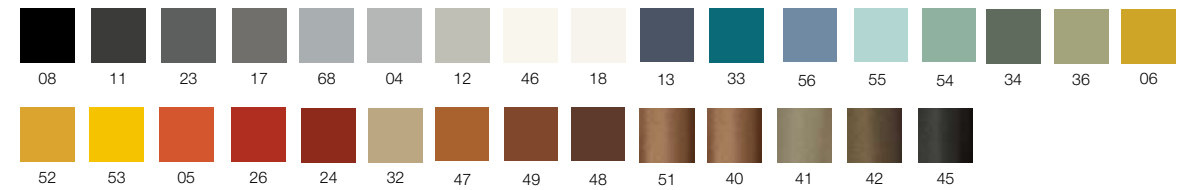

Struttura cromata / Chromed frame / Structure chromée / Gestell Verchromt



Struttura spazzolata / Brushed frame / Structure brossée / Gestell Gebürstet



Legno / Wood / Bois / Holz (art. S0200-S0201-G0202-G0203)























TO-BE

Archirivolto Design

Innovativa nei dettagli, To-Be è una seduta adatta ai più molteplici usi. Declinata in una selezione di finiture e varianti per una collezione completa, dal polipropilene al tessuto, dal legno al metallo per le basi, in grado di vestire situazioni molto diverse, dal contract alla casa, con uno stile sempre attuale.

The innovative details of the To-Be collection enhance its ability to complement varied situations from contract to residential. A multitude of finishes and options complete the To-Be family of seating, both wood and metal bases with an evergreen style.

Innovateur dans les détails, To-Be est un siège qui s'adapte à de multiples utilisations. Décliné dans une sélection de finitions et de variantes pour une collection complète. Bois et métal, pour les structures, assises en polypropylène et revêtues, pour des univers allant du contract à la maison, le tout dans un style très actuel.

Die Innovation steckt im Detail: To-Be ist ein extrem vielseitiger Sessel. Erhältlich in einer großen Auswahl von Ausführungen und Varianten. Von Polypropylen bis zu Stoff über Holz bis Metall für die Sesselstruktur; stets präsentiert sich To-Be in einem zeitgemäßen Design und ist für den Objektbereich wie für den Wohnraum einsetzbar.

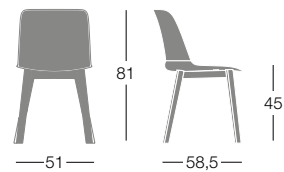

S0170

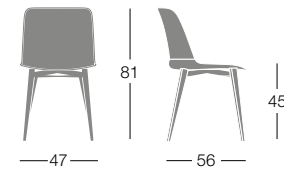

S0175

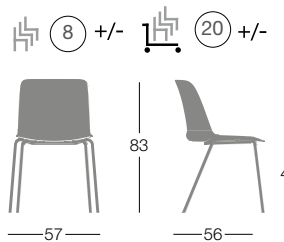

S0160

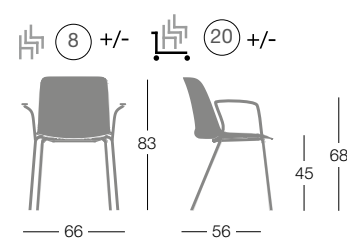

S0160B

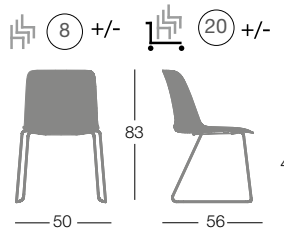

S0165

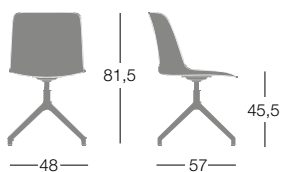

R0100

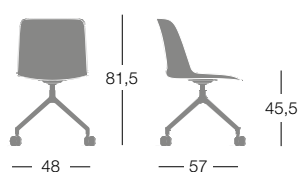

R0105

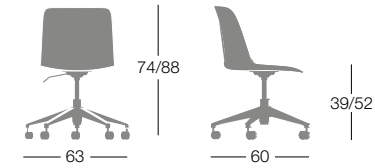

R0108

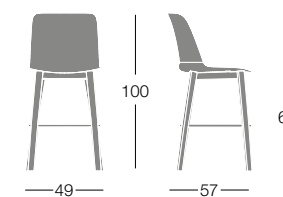

G0160

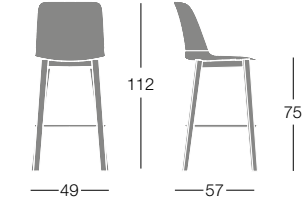

G0165

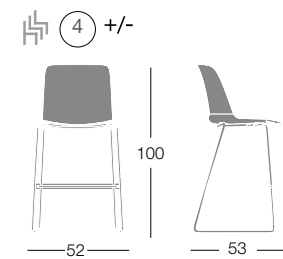

G0170

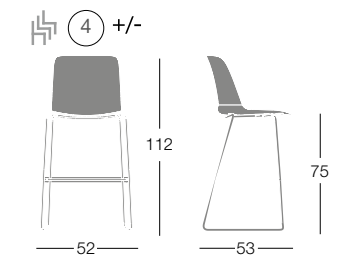

G0174

Finiture / Finishes / Finitions / Ausführungen

Polipropilene / Polypropylene / Polypropylène / Kunststoff

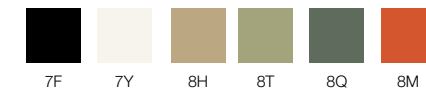

Struttura / Frame / Structure / Gestell

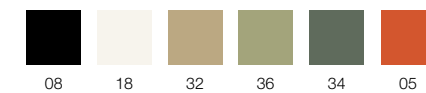

Struttura cromata / Chromed frame / Structure chromée / Gestell Verchromt



02

Struttura spazzolata / Brushed frame / Structure brossée / Gestell Gebürstet



67

Legno / Wood / Bois / Holz (art. S0170-G0160-G0165)

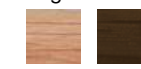

FA 02 FG 07



Greenvale Secondary College, Greenvale, Victoria, Australia



Gaming Company, Romania



TO-BE OUTDOOR

Archirivolto Design

To-Be Outdoor é uno stile classico e consolidato che segue le linee della seduta in polipropilene, privilegiando il comfort e la versatilità. Sedia con o senza braccioli, sgabello e lounge hanno linee estetiche funzionali ed essenziali che consentono di inserire questa seduta in ogni tipo di spazio all'aperto.

To-Be Outdoor is a classic and consolidated style which follows the lines of the original polypropylene shell, preserving comfort and versatility. Chair with or without armrests, stool and lounge have functional and essential aesthetic lines, that allow to furnish any type of outdoor space.

To-Be Outdoor est un style classique et consolidé qui suit les lignes de la coque originale en polypropylène, en préservant son confort et sa polyvalence. La banquette lounge 2 places, aux lignes esthétiques essentielles et fonctionnelles, complète la famille Outdoor

To-Be Outdoor spiegelt einen klassischen und konsolidierten Stil, der den Linien der ursprünglichen Polypropylenschale folgt und gleichzeitig deren Komfort und Vielseitigkeit beibehält. Die ästhetische 2-Sitzer-Loungebank mit essentiellen und funktionalen Linien vervollständigt die Outdoor-Familie.

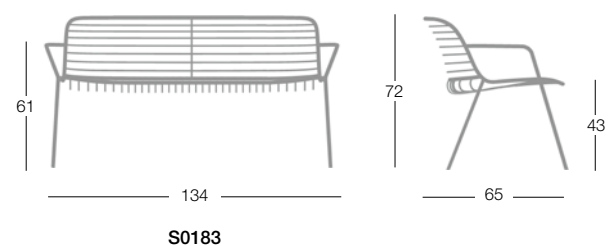
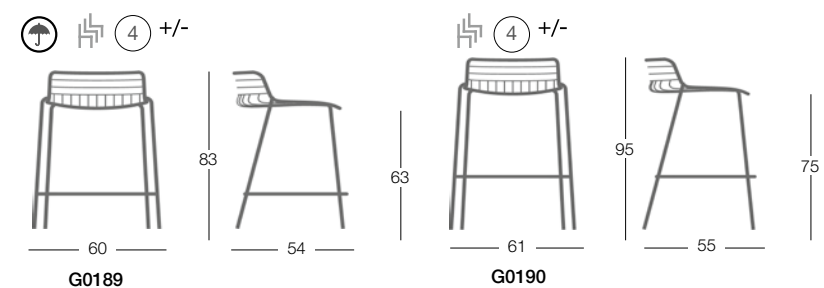
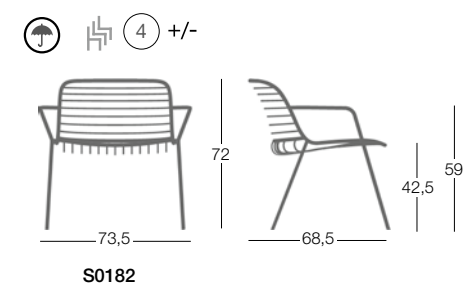
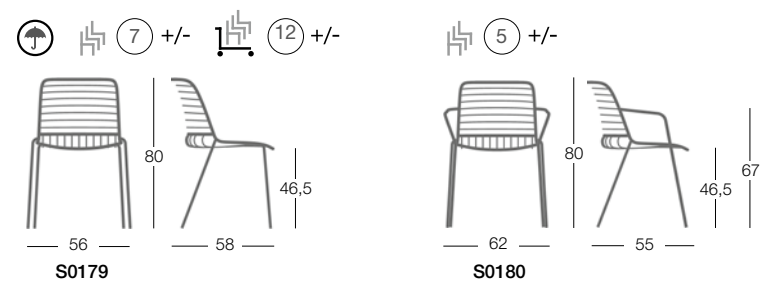

Finiture / Finishes / Finitions / Ausführungen

Struttura / Frame / Structure / Gestell

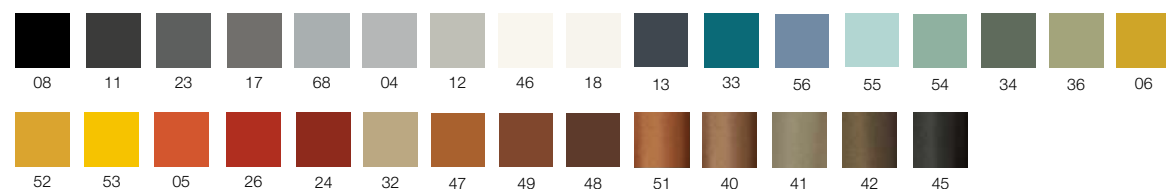







Private House, San Gimignano, Italy

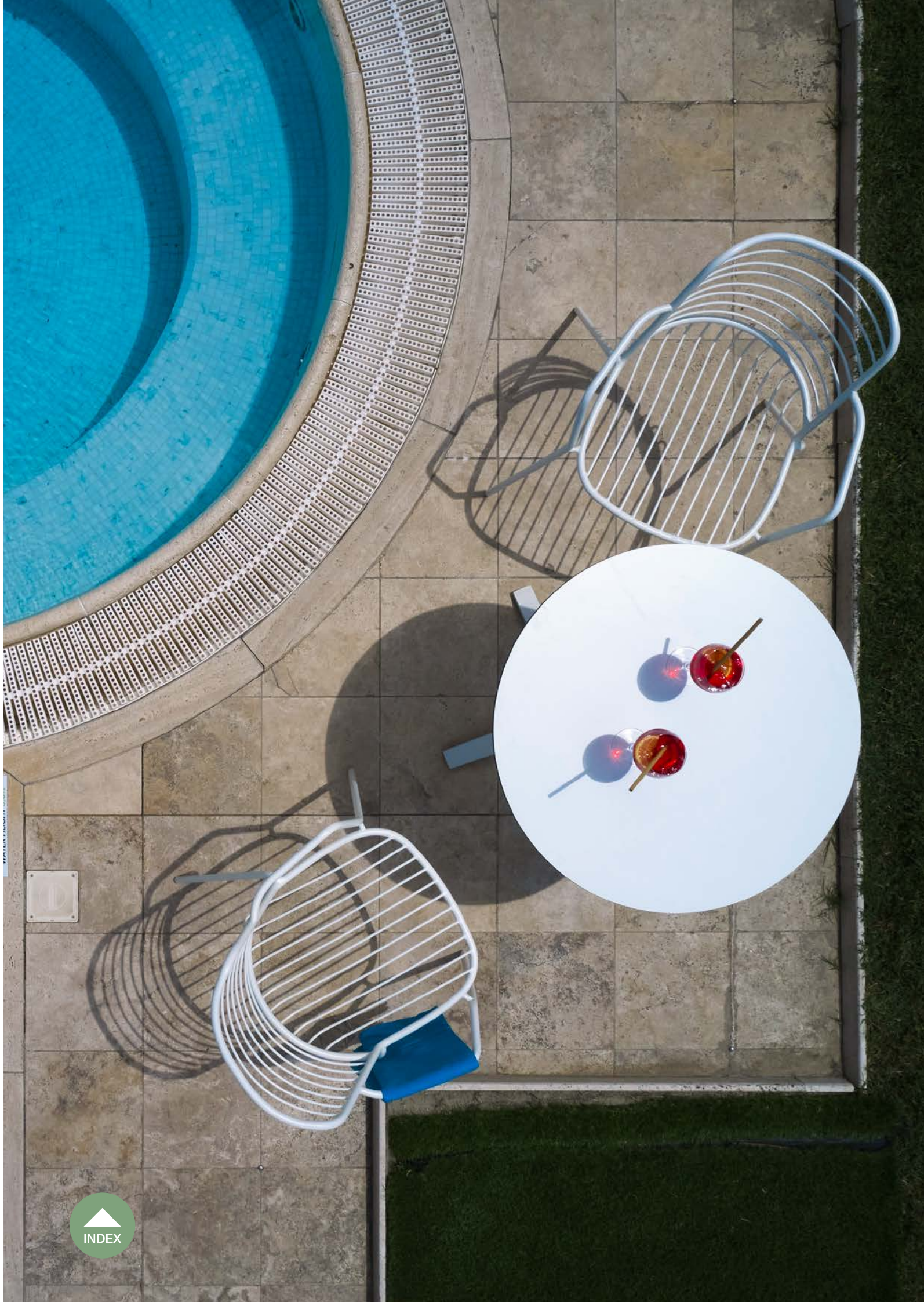



TAVOLI
TABLES
TABLES
TISCHE

AGORÀ / AGORÀ DOUBLE

AGORÀ

Cisotti & Laube

AGORÀ
Oltre alla collezione di imbottiti, Agorà comprende una versatile serie di tavolini in metallo verniciato che, in virtù delle varie altezze e dimensioni, risulta facilmente collocabile nei contesti più disparati, sia in abbinamento all'omonima gamma sia in abbinamento ad altri pezzi.

AGORÀ
Agorà, a versatile collection of tables in powder coated steel that, thanks to its heights and dimensions, can be easily placed in different contexts together with Agorà upholstered seating or in combination with other lounges.

AGORÀ
En complément de la collection d'assises rembourrés, Agorà propose une série de tables en métal en différentes hauteurs et dimensions permettant de s'adapter à tout type de besoin, que ce soit avec les assises de la collection ou avec d'autres gammes.

AGORÀ
Neben der Kollektion von Polstermöbeln umfasst Agorà eine vielseitige Serie von Tischen aus epoxydlackiertem Metall, passend zu jedem Ambiente und Stil.

AGORÀ DOUBLE
Il nuovo tavolino della famiglia Agorà si ispira al mondo dell'origami e al delicato fascino della leggerezza e ne esalta il concetto, raddoppiandolo. Due piani di appoggio in un oggetto unico e multifunzionale.

AGORÀ DOUBLE
The Agorà family presents a new member inspired by the world of origami, doubling it. Two tops in a single, multi-functional table.

AGORÀ DOUBLE
La nouvelle table de la famille Agorà s'inspire du charme délicat et de la légèreté de l'origami. Elle vient enrichir le concept en le doublant. Deux plateaux pour une table multifonctionnelle.

AGORÀ DOUBLE
Der neue Tisch der Familie Agorà besticht mit seiner, von der Origami-Kunst inspirierten, filigranen Leichtigkeit, welche durch die Verdoppelung der Struktur eine Steigerung erfährt. Zwei Tischplatten vereint in einer multifunktionalen Lösung.

AGORÀ

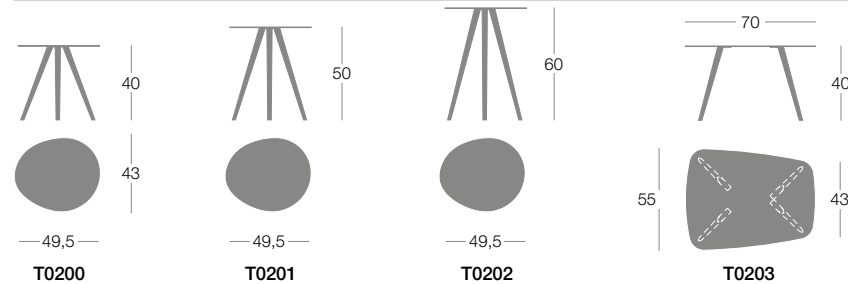

AGORÀ DOUBLE

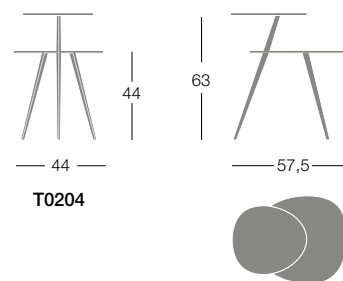

Finiture / Finishes / Finitions / Ausführungen

Struttura / Frame / Structure / Gestell

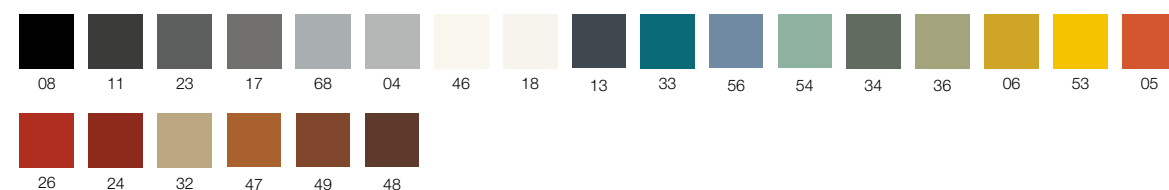

tavoli / tables / tables / Tische





AGORÀ DOUBLE



ARTFUL

Massimiliano Mornati

Tavolo dalle linee essenziali e rigorose, è frutto di un'attenta ricerca di design. Si distingue, infatti, per l'originale concetto di composizione delle gambe, in rovere massello, disposte perpendicolarmente e ad angolo in modo da suggerire una condizione di circolarità che amplifica la leggerezza complessiva del pezzo. Disponibile in 2 diverse dimensioni è ideale sia per ambienti professionali sia per living e spazi residenziali.

Table with essential and rigorous lines stands out for its original legs composition. These are arranged perpendicularly as well as at an angle, suggesting a circularity that amplifies the overall lightness of the piece. Available in 2 different dimensions, Artful is perfect for both corporate meeting spaces and residential living areas.

Cette table aux lignes pures et rigoureuses est le fruit de recherches intenses. Elle se distingue, en effet, par l'originalité de son piètement, en chêne massif, disposé perpendiculairement et incliné de manière à suggérer une impression de mouvement afin de donner plus de légèreté à la pièce. Disponible en 2 dimensions, cette table est idéale pour les espaces professionnels mais aussi pour les espaces résidentiels.

Eine puristische Linie mit origineller Beinstellung zeichnet diesen Tisch aus. Die Beine aus Massiveiche, senkrecht placiert suggerieren Leichtigkeit. Verfügbar in 2 Massen. Artful ist ideal sowohl im Objektbereich, als auch für den privaten Wohnbereich.

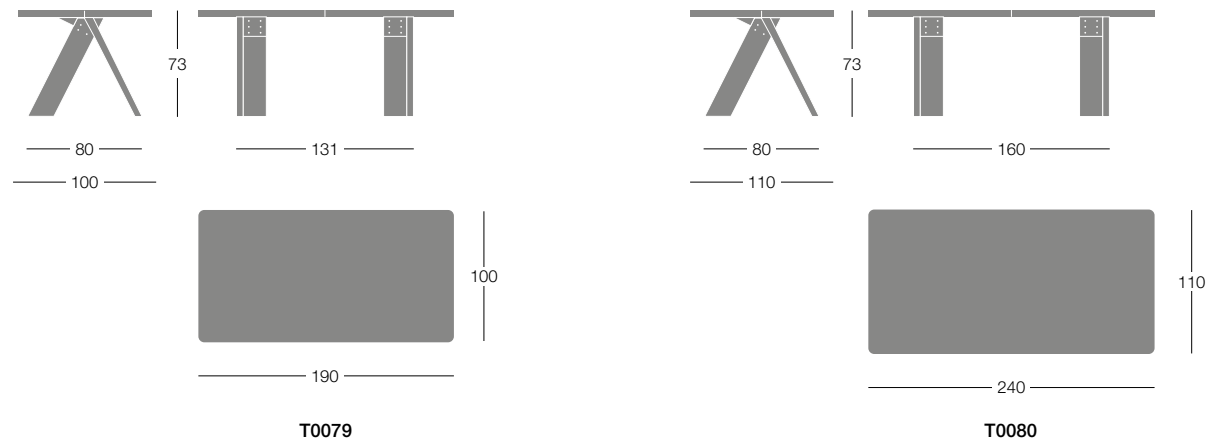

Finiture / Finishes / Finitions / Ausführungen

Legno / Wood / Bois / Holz

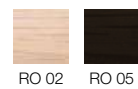





BOOM COLLECTION

U.T.S

Boom riunisce in un'unica collezione gli iconici tavolini nella loro versione "Round", "Square" e "Rectangular". Base, colonna e piano possono essere circolari, quadrati e combinarsi fra loro senza vincoli. I piani, disponibili in vari materiali e dimensioni, si abbinano a una struttura in acciaio ad alta resistenza, verniciata goffrata oppure cromata. Disponibile in varie altezze, Boom, per le sue caratteristiche di essenzialità e funzionalità, è l'ideale per uno spazio performante e confortevole.

Boom collection brings together in a single series the iconic tables in their round, square and rectangular versions. Base, column and top can be round or square and combine with each other without constraints. Tops are available in various materials and sizes; bases and columns in high-strength steel may be in powder coat, chrome, or brushed stainless. Essential and extremely functional, Boom is perfect for both performing and comfortable spaces.

La collection Boom réunit en une seule collection de structures de tables rondes, carrées et rectangulaires. La base, la colonne et le plateau peuvent être ronds ou carrés et on peut les mélanger à l'infini. Les plateaux, disponibles en différents matériaux et dimensions, sont associés à une structure en acier haute résistance, avec finition gaufrée ou chromée. La collection Boom "sobre et fonctionnelle" est idéale pour un espace performant et confortable.

Die ikonische Tischkollektion Boom umfasst runde, quadratische und rechteckige Fussgestelle. Diese können problemlos miteinander kombiniert werden. Passend zu den Gestellen aus widerstandfähigem Stahl, pulverbeschicht oder verchromt, sind Platten in verschiedenen Größen und Materialien. Boom ist der ideale Tisch für jeden Raum.

* altezza tavolo piano escluso / base height without top / hauteur base hors plateau / Höhe Tischgestell ohne Platte

BOOM ROUND

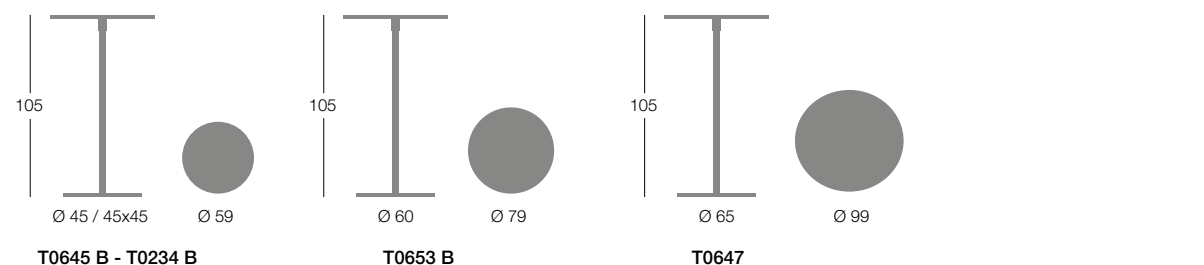
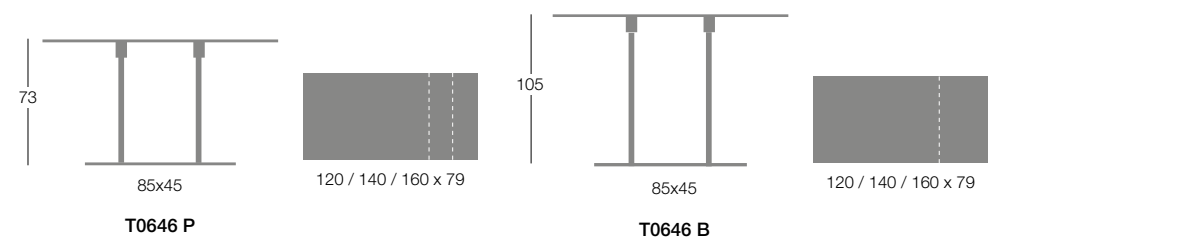
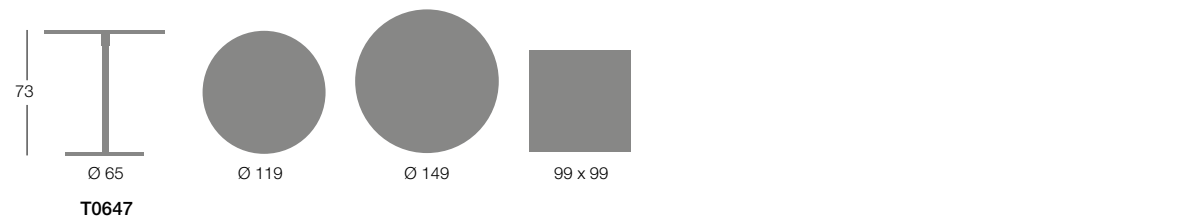
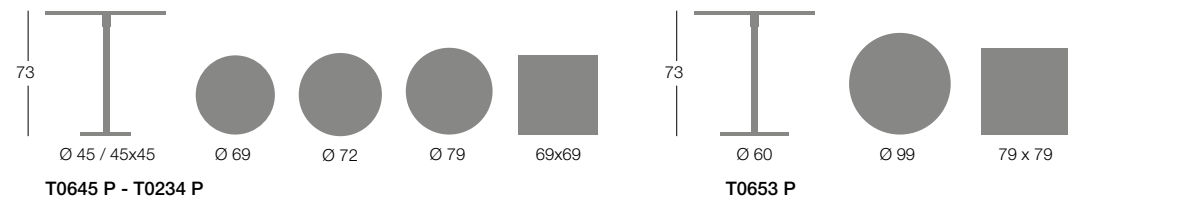
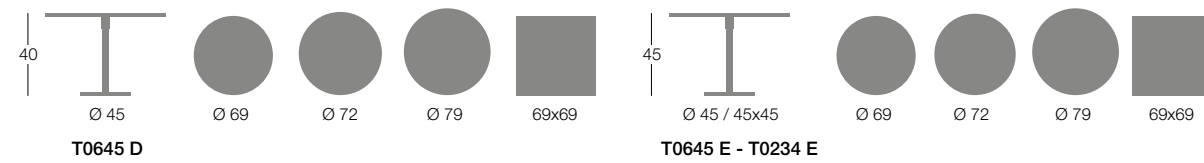

* altezza tavolo piano escluso / base height without top / hauteur base hors plateau / Höhe Tischgestell ohne Platte

BOOM SQUARE

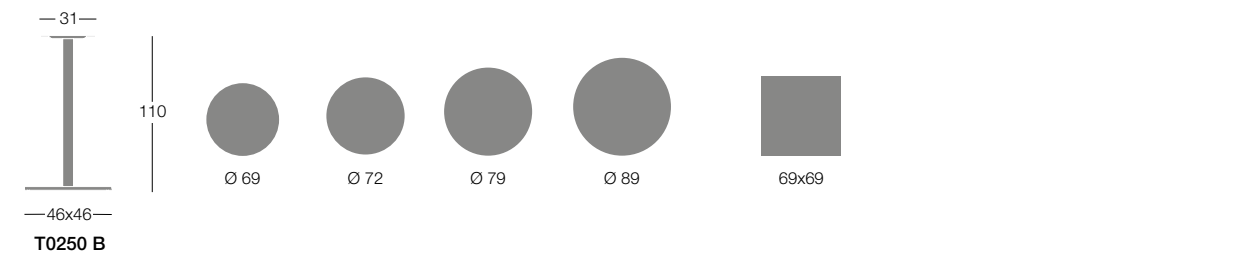
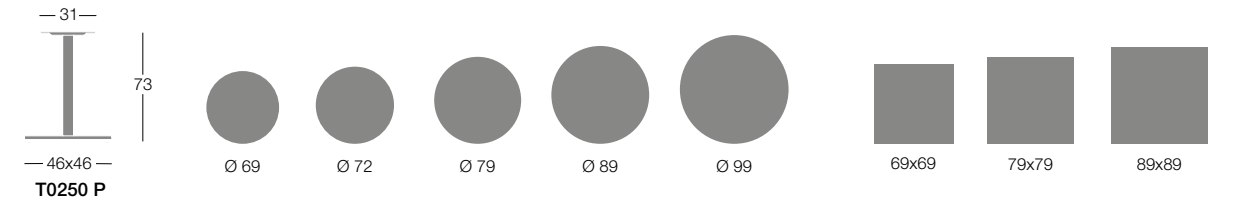

Finiture / Finishes / Finitions / Ausführungen

Struttura / Frame / Structure / Gestell

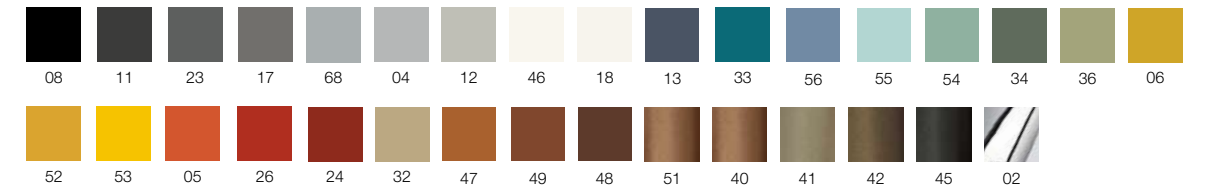

Piani tavolo / Table tops / Plateaux de table / Tischplatten

Nobilitato con bordo ABS / Melamine with ABS edge / Mèlaminé avec chants ABS / Melaminplatte mit ABS-Kante (art. PNL)
Spessore / Thickness / Epaisseur / Stärke: 25 mm

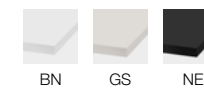

Laminato su truciolare bordo ABS / Laminate on chipboard with ABS edge / Stratifié sur aggloméré avec chants ABS / Laminiert auf Spanplatte mit ABS-Kante (art. PLT)
Spessore / Thickness / Epaisseur / Stärke: 24 mm



HPL (art. PHP)

Spessore / Thickness / Epaisseur / Stärke: 10 mm



Lamiera verniciata / Powder coated steel / Acier laqué epoxy / Metall Epoxydlackiert (art. PMT)
Spessore / Thickness / Epaisseur / Stärke: 19 mm

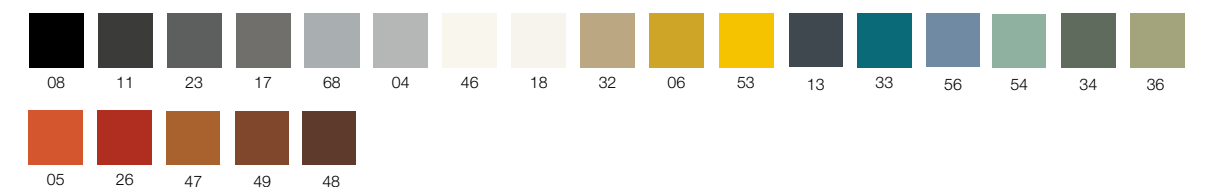







COMPASSO

Orlandini Design

Il tavolo, multifunzionale e configurabile per uso individuale o collettivo, si ispira alla forma del compasso, che gli dona un aspetto leggero, quasi etereo ma al tempo stesso bilanciato nei pesi e nelle proporzioni. Il piano risulta in bilico sul vertice delle gambe, un equilibrio apparentemente precario che rivela invece una estrema solidità strutturale.

The Compasso table is inspired by the shape of the compass, that gives the table a light, almost ethereal appearance, but at the same time balanced in weight and proportions. The tabletop is sitting on the vertex of the legs, an apparently precarious balance that instead reveals extreme structural solidity. The supporting structure, made with iron legs, has in its aluminium joint the real characterizing element of the table, technology and aesthetics that combine for a solid and elegant structure.

La table Compasso, s'inspire de la forme de la boussole, ce qui lui donne un aspect léger, presque éthéré mais en même temps équilibré en poids et en proportions. Le plateau est quasi en équilibre sur le sommet des pieds, un équilibre apparemment précaire qui révèle au contraire d'une extrême solidité structurelle. La structure portante, réalisée avec des pieds en métal, est le véritable élément caractéristique de la table avec le joint en aluminium qui les relie; technologie et esthétique qui s'unissent pour une structure solide et élégante.

Der Tisch, multifunktional und konfigurierbar für den individuellen oder kollektiven Gebrauch, ist von der Form des Kompasses inspiriert, die ihm ein leichtes, fast ätherisches, aber gleichzeitig ausgewogenes Aussehen hinsichtlich Massen und Proportionen verleiht. Die Platte ruht auf dem Scheitel der Füße, ein scheinbar prekäres Gleichgewicht, das hingegen eine extreme strukturelle Festigkeit offenbart.

* altezza tavolo piano escluso / base height without top / hauteur base hors plateau / Höhe Tischgestell ohne Platte

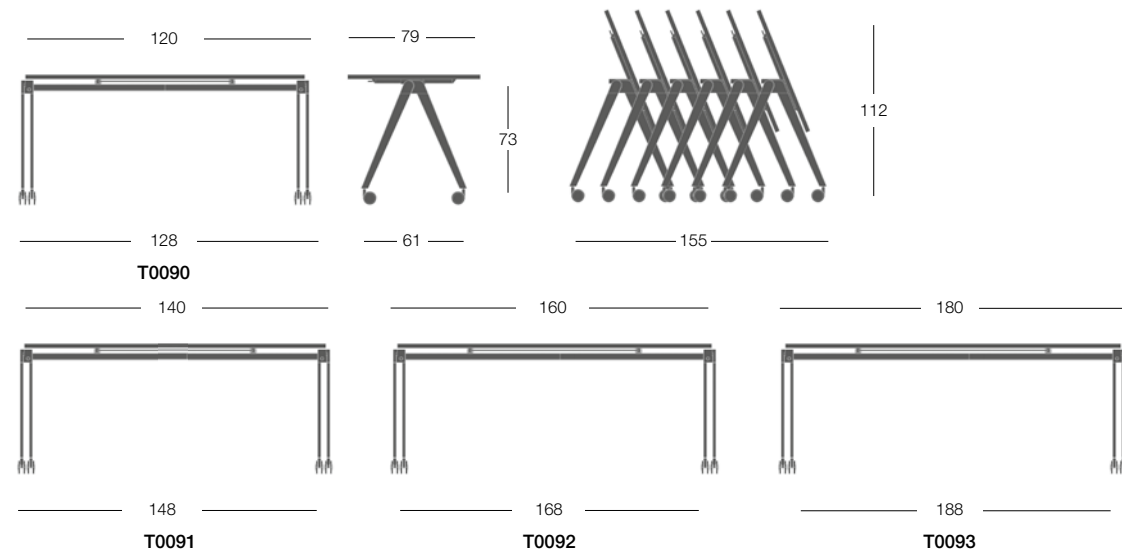

Finiture / Finishes / Finitions / Ausführungen

Struttura verniciata / Powder coated frame / Structure laquée / Gestell Lackiert

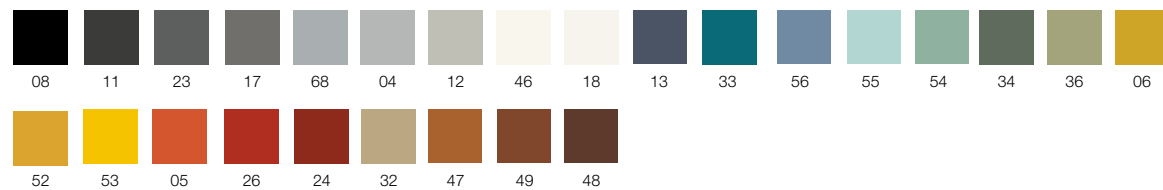

Piani tavolo / Table tops / Plateaux de table / Tischplatten

Nobilitato con bordo ABS / Melamine with ABS edge / Mèlaminé avec chants ABS / Melaminplatte mit ABS-Kante (art. PNL)
Spessore / Thickness / Epaisseur / Stärke: 25 mm



Laminato su truciolare bordo ABS / Laminate on chipboard with ABS edge / Stratifié sur aggloméré avec chants ABS / Laminat auf Spanplatte mit ABS-Kante (art. PLT)
Spessore / Thickness / Epaisseur / Stärke: 24 mm



HPL (art. PHP)

Spessore / Thickness / Epaisseur / Stärke: 10 mm



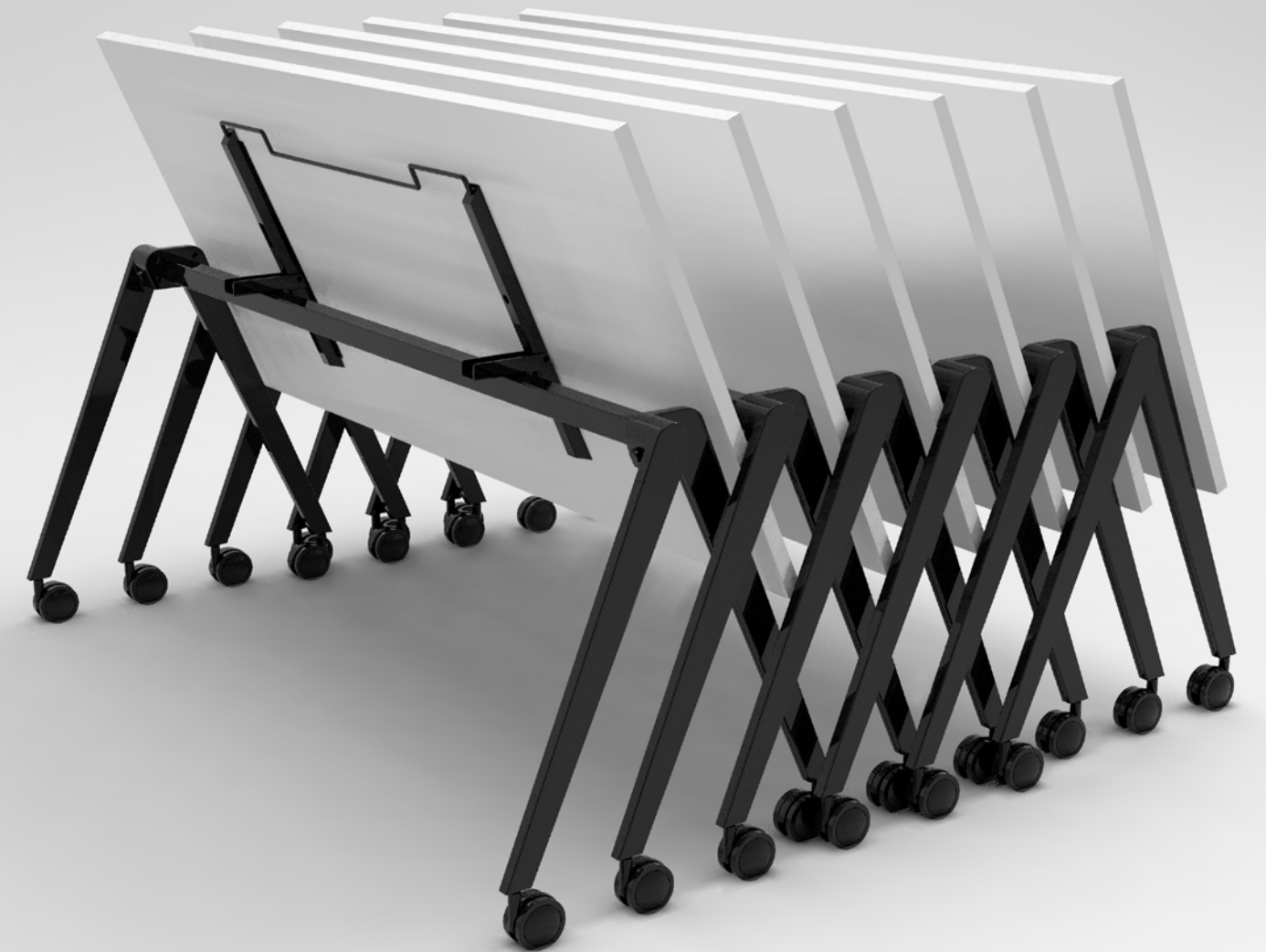

CONI

Luigi Trenti

Dinamico nell'aspetto e resistente nella struttura, Coni è un tavolo dalla colonna a forma di clessidra, dotato di un basamento e un piano circolari.

La base, in acciaio verniciato, è disponibile in due dimensioni da utilizzare secondo la misura dei piani, presenti in diverse grandezze e finiture. La colonna viene realizzata in polietilene riciclabile stampato in roto-moulding.

Coni, delicate yet strong, is a table without edges. It features a conical shaped column of roto-moulded polyethylene. The powder coated base is available in two sizes with tops in different sizes and finishes.

Coni, malgré son apparence légère, sa structure est très résistante. Elle est constituée d'une base et d'un plateau circulaire, sa colonne a une forme conique. La base, en acier avec finition époxy laquée, est disponible en deux dimensions. La colonne est en polyéthylène recyclable roto-moulé. Les plateaux sont disponibles en différentes dimensions et finitions.

Coni, dynamisch und stark zugleich, mit der Säule in der Form einer Zeituhr, Fuss und Platte sind rund. Der Fussteller aus pulverbeschichtetem Stahl ist in zwei Größen je nach Plattengröße verfügbar. Diese sind in verschiedenen Ausführungen lieferbar. Die Säule ist aus Polyethylen in Rotationsverfahren hergestellt.

* altezza tavolo piano escluso / base height without top / hauteur base hors plateau / Höhe Tischgestell ohne Platte

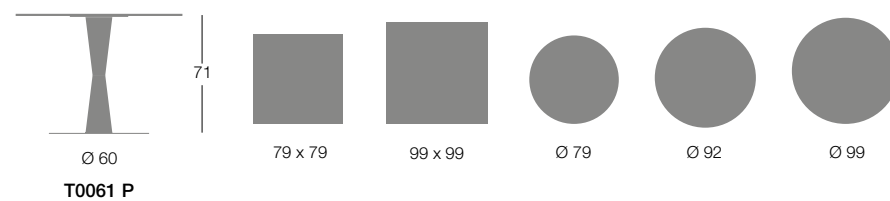
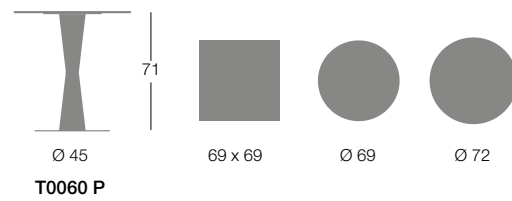

Finiture / Finishes / Finitions / Ausführungen

Base metallo / Metal base

Base en metal / Fussteller Metal

Colonna polietilene / Polyethylene column

Colonne en polyéthylène / Säule Polyethylen

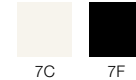
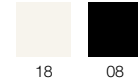

Piani tavolo / Table tops / Plateaux de table / Tischplatten

Nobilitato con bordo ABS / Melamine with ABS edge / Mèlaminé avec chants ABS / Melaminplatte mit ABS-Kante (art. PNL)
Spessore / Thickness / Epaisseur / Stärke: 25 mm

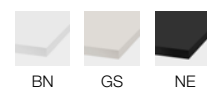

Laminato su truciolare bordo ABS / Laminat on chipboard with ABS edge / Stratifié sur aggloméré avec chants ABS /

Laminat auf Spanplatte mit ABS-Kante (art. PLT)

Spessore / Thickness / Epaisseur / Stärke: 24 mm



HPL (art. PHP)

Spessore / Thickness / Epaisseur / Stärke: 10 mm



Lamiera verniciata / Powder coated steel / Acier laqué epoxy / Metall Epoxydlackiert (art. PMT)

Spessore / Thickness / Epaisseur / Stärke: 19 mm

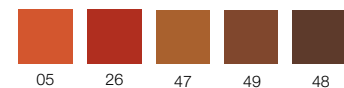
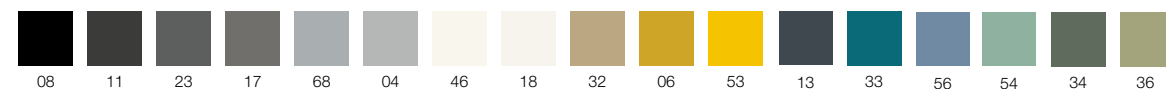



CULT

UTS

Cult è il tavolo che completa ed esalta la linea dell'omonima sedia, partendo dall'idea comune di disegnare un pezzo in armonia tra spunti moderni e ispirazioni dal sapore vintage. Ha una struttura in acciaio, dalla finitura verniciata, piani disponibili in vari materiali.

Cult table stands alone or may be combined with its homonymous Cult chair, both with contemporary lines and a vintage touch. Steel frame in powder coat with tops in various materials

Cult est une structure de table qui complète et enrichit la gamme de chaises du même nom. Elle représente la synthèse parfaite du design moderne et des inspirations vintage. Elle dispose d'une structure en acier, avec une finition époxy laquée, et des plateaux disponibles dans des matériaux très variés.

Dieser Tisch macht sowohl mit dem gleichnamigem vintage Stuhl Cult, als auch alleine eine gute Figur. Gestell aus pulverbeschichtetem Stahl mit Platten in verschiedenen Materialien.

* altezza tavolo piano escluso / base height without top / hauteur base hors plateau / Höhe Tischgestell ohne Platte

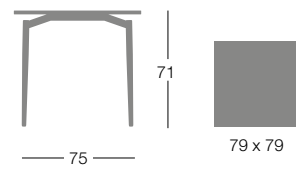

T0015

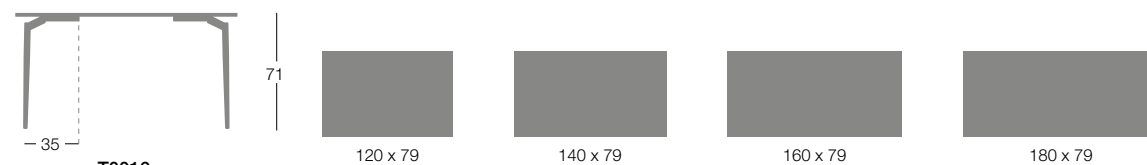

T0016

Finiture / Finishes / Finitions / Ausführungen

Struttura / Frame / Structure / Gestell

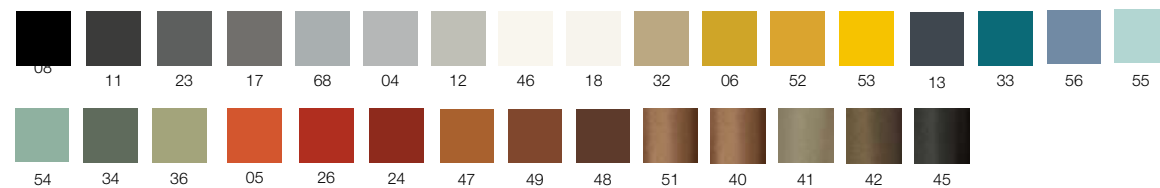

Piani tavolo / Table tops / Plateaux de table / Tischplatten

Nobilitato con bordo ABS / Melamine with ABS edge / Mèlaminé avec chants ABS / Melaminplatte mit ABS-Kante (art. PNL)
Spessore / Thickness / Epaisseur / Stärke: 25 mm



Laminato su truciolare bordo ABS / Laminate on chipboard with ABS edge / Stratifié sur aggloméré avec chants ABS /
Laminat auf Spanplatte mit ABS-Kante (art. PLT)
Spessore / Thickness / Epaisseur / Stärke: 24 mm



HPL (art. PHP)
Spessore / Thickness / Epaisseur / Stärke: 10 mm





EASY BOY / EASY BOY SMART Y-BOY

EASY BOY

Bartoli Design

EASY BOY / EASY BOY SMART
Easy Boy è un tavolino versatile, adatto a tutte le situazioni in cui è utile disporre di un appoggio stabile. Solido, grazie alla struttura in acciaio, ha una forma morbida e misure pensate appositamente per essere accostato a poltrone e divani. Disponibile in tre altezze e una variante con tripla presa USB. Finiture in vari colori, dai più sobri ai più vivaci.

EASY BOY / EASY BOY SMART
Easy Boy is the table for every environment where it is useful to have a stable support. Solid steel frame with a soft shape and dimensions designed specifically to be combined with armchairs and sofas. Available in three heights and a version with a push 3-USB socket in various colours, from the most sedate to the most lively.

EASY BOY / EASY BOY SMART
Easy Boy est la table parfaite pour répondre aux besoins d'un support stable. Sa structure en acier très solide vient compléter sa forme très douce. Ses dimensions s'adaptent parfaitement avec des fauteuils et des canapés. Disponible en différentes hauteurs et une variante avec prise USB. Couleurs des plus sobres aux plus vives.

EASY BOY / EASY BOY SMART
Easy Boy ist ein vielseitiger Beistelltisch für alle Anlässe, in denen eine stabile Stütze nützlich ist. Solide, dank der Stahlstruktur, weist er eine geschmeidige Form und Maße auf, die speziell für die Kombination mit Sesseln und Sofas entwickelt wurden. Erhältlich in drei Höhen und einer Variante mit dreifachem USB-Anschluss. Ausführungen in verschiedenen Farben, von den nüchternsten bis zu den lebhaftesten.

Y-BOY
La versione Y-Boy permette di avvicinare perfettamente il tavolino al divano o alla poltrona grazie alla scanalatura che caratterizza la base in acciaio.

Y-BOY
A grooved steel base allows Y-Boy to be moved closer to the sofa or armchair.

Y-BOY
La forme de la base permet de rapprocher Y-Boy du canapé ou du fauteuil.

Y-BOY
Die Version „Y-Boy“ ermöglicht es, den Beistelltisch dank der Nut, die die Stahlbasis kennzeichnet, perfekt an das Sofa oder den Sessel heranzuführen.

EASY BOY

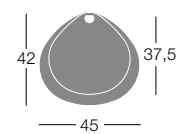
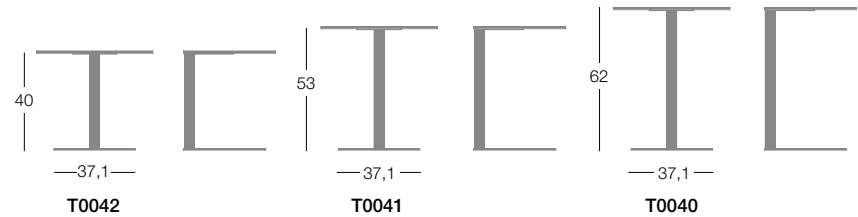

EASY BOY SMART

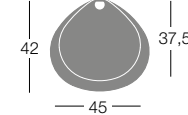
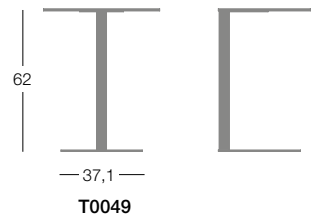

Y-BOY

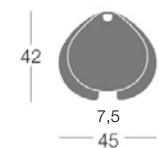
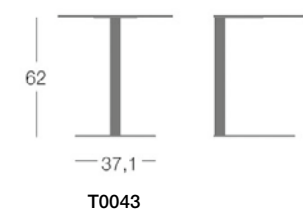

Finiture / Finishes / Finitions / Ausführungen

Struttura / Frame / Structure / Gestell

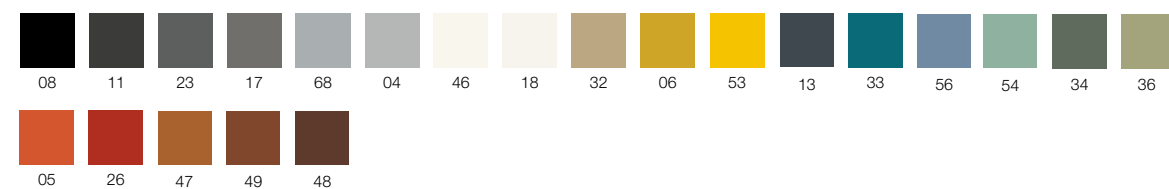









FOLD UP

Lucci & Orlandini

Agile, pratico e pieghevole Fold Up è un prodotto flessibile e resistente, perfetto per catering e convention. Presenta una struttura in acciaio, verniciata o cromata e piani in nobilitato in 3 finiture. Disponibile in due dimensioni, Fold-Up è pratico e funzionale e dotato di carrello porta-tavoli per lo stoccaggio.

A folding table, flexible and sturdy, perfect for catering, conventions and meeting rooms. Fold-Up is available in two dimensions with steel frame available in powder coat or chrome finish and melamine tops in 3 colours. Easy to store with dedicated trolley.

Fold Up, pratique et pliante, est un produit à la fois flexible et résistant, idéal pour les salles de séminaires, de convention et la restauration. Disponibles en deux dimensions avec une structure en acier, époxy laqué ou chromée et un plateau en mélaminé en 3 coloris. Il existe aussi un chariot permettant de stocker les tables une fois repliées.

Praktisch, zusammenklappbar ist dieser Tisch flexibel und robust, ideal für Catering und Meetingräume. Struktur aus Stahl, in zwei Massen, epoxylackiert oder verchromt, mit Melaminplatten in 3 Farben. Zubehör: Transportwagen.

* altezza tavolo piano escluso / base height without top / hauteur base hors plateau / Höhe Tischgestell ohne Platte

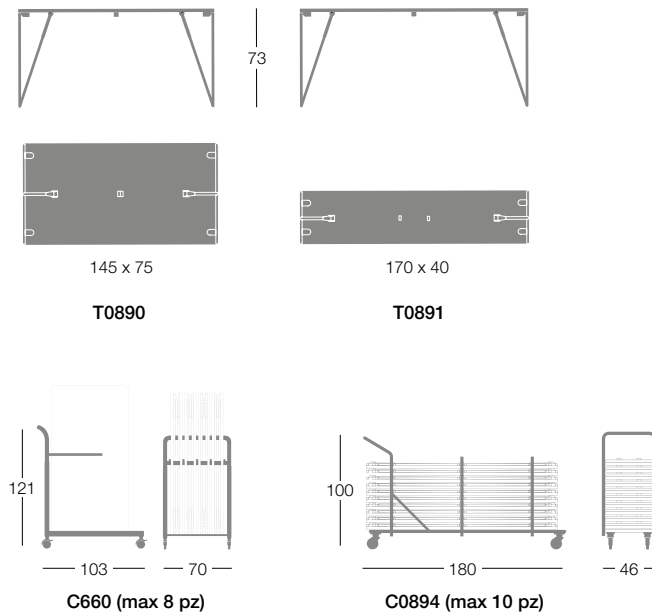

Finiture / Finishes / Finitions / Ausführungen

Struttura / Frame / Structure / Gestell



Piani tavolo / Table tops / Plateaux de table / Tischplatten

Nobilitato con bordo ABS / Melamine with ABS edge / Mélaminé avec chants ABS / Melaminplatte mit ABS-Kante (art. PNL)
Spessore / Thickness / Epaisseur / Stärke: 25 mm





Accademia Stauffer, Cremona, Italy





Pramac Racing, Moto GP , Italy



HOTEL

Cisotti & Laube

Tavolini bassi disponibili in due altezze e due misure, sovrapponibili.

Multifunctional tables available in two heights and two dimensions.

Tables basses gigognes de dimensions et hauteurs différentes.

Beistelltische in zwei Höhen und zwei Größen erhältlich, stapelbar.

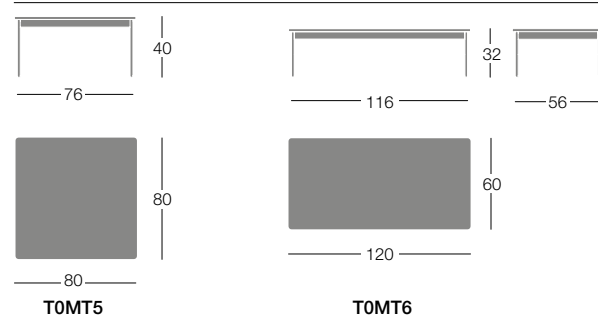

Finiture / Finishes / Finitions / Ausführungen

Struttura / Frame / Structure / Gestell

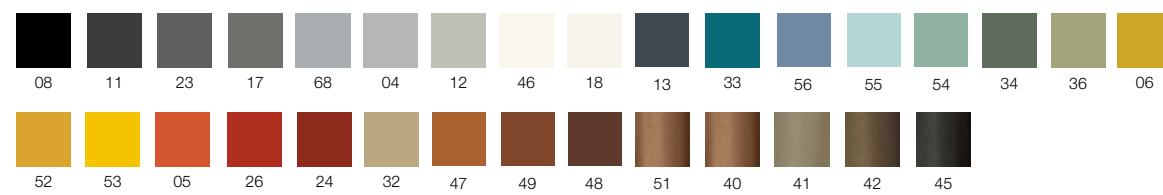

Laminato su truciolare bordo ABS / Laminat on chipboard with ABS edge
Stratifié sur aggloméré avec chants ABS / Laminat auf Spanplatte mit ABS-Kante (art. PLT)
Spessore / Thickness / Epaisseur / Stärke: 24 mm

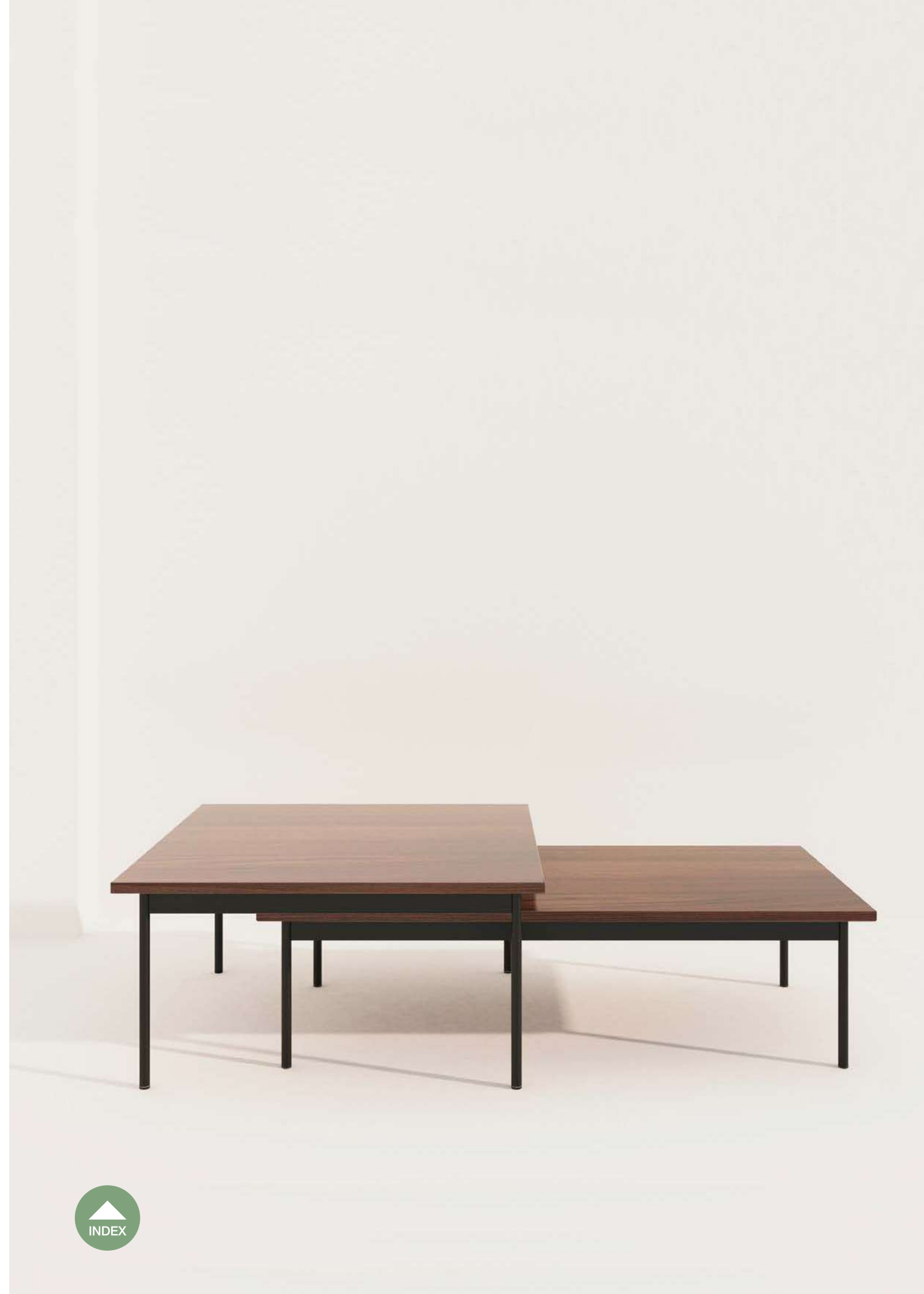



JUXT

UTS

La base solida e il piano ribaltabile fanno di Juxt un sistema di tavoli ideale per spazi mutevoli, che si aprono e si ritirano a seconda delle ore del giorno. Le strutture accostabili rendono il tavolino ancora più maneggevole e la possibilità di scegliere tra diversi piani, ne fanno un prodotto eclettico e versatile.

Solid base and folding top make Juxt ideal for spaces where tables need to be opened then closed for storage. A versatile product, it can be stacked and has the option of either square or round top.

De par sa base solide et son plateau rabattable, Juxt est un système de structure de table idéal pour les espaces flexibles suivant l'heure de la journée. Les structures empilables rendent la table encore plus flexible et la possibilité de choisir entre différents plateaux, carrés ou ronds, en font un produit parfaitement polyvalent.

Stabile Struktur mit einer seitlich klappbarer Platte JUXT ist ideal für Räume, wo man Tische nach dem Gebrauch lagern möchte. Ein vielseitiges Produkt seitlich ineinander platzsparend anreihbar mit runden oder rechteckigen Platten.

* altezza tavolo piano escluso / base height without top / hauteur base hors plateau / Höhe Tischgestell ohne Platte

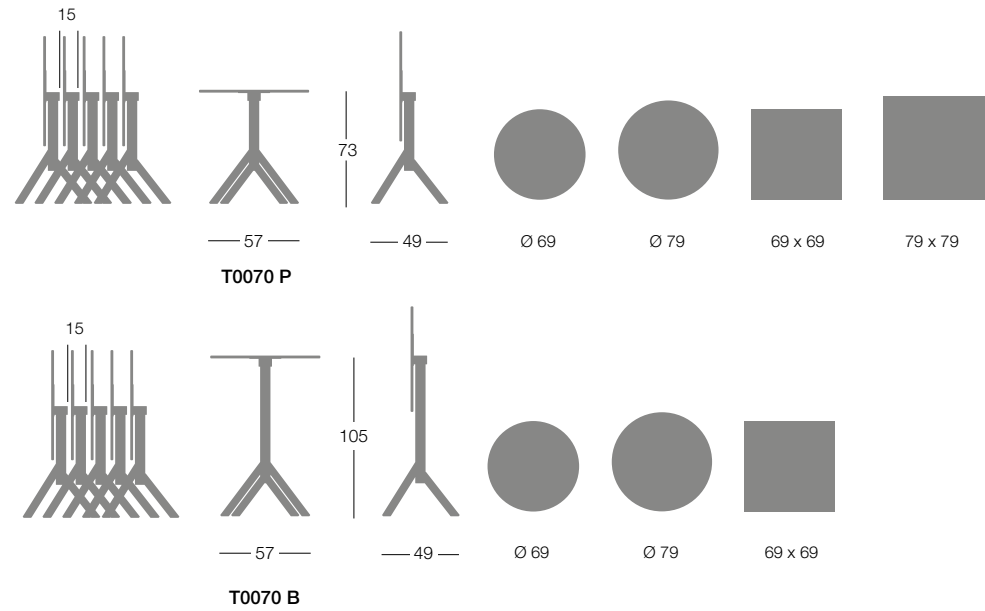

Finiture / Finishes / Finitions / Ausführungen

Struttura / Frame / Structure / Gestell

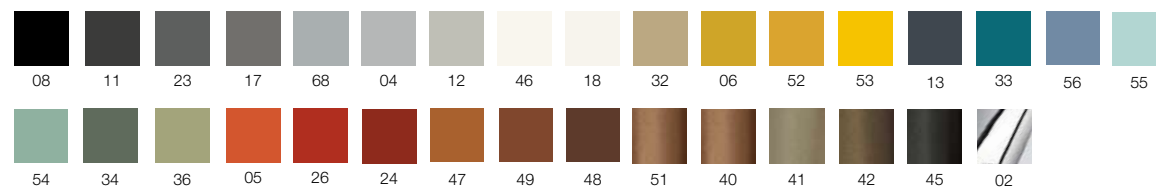

Piani tavolo / Table tops / Plateaux de table / Tischplatten

HPL (art. PHP)

Spessore / Thickness / Epaisseur / Stärke: 10 mm



NR*: nero anti-impronta / black anti fingerprint / noir anti-traces de doigts / Schwarz No-Print



K COLLECTION

Bartoli Design

K Collection è una collezione di tavoli in grado di soddisfare le esigenze più svariate, sia in interno sia in esterno. Contrassegnato da un base in pressofusione di alluminio da due a cinque razze e da una o due colonne centrali, è disponibile in diverse altezze, oltre a prevedere la possibilità di utilizzare piani in diverse forme e dimensioni.

K Collection is a series of tables for any environment, indoor and outdoor. Characterized by a base in die-cast aluminium with two to five spokes and one or two central columns. Available in different heights, K Collection offers the option of numerous top shapes and sizes.

K Collection est un système de structures de table qui s'adapte à tout type d'environnement, intérieur comme extérieur. Sa base en fonte d'aluminium de deux à cinq branches et sa colonne centrale disponible en différentes hauteurs permettent d'utiliser des plateaux de différentes formes et dimensions.

K Collection ist eine Tischserie für jeden Einsatz, Innen- und Aussenbereich. Gestelle aus Aludruckguss mit zwei bis fünf Fusstützen und eine oder zwei Säulen. Verfügbar in verschiedenen Höhen mit der Möglichkeit diverse Plattengrößen und Formen zu wählen.

* altezza tavolo piano escluso / base height without top / hauteur base hors plateau / Höhe Tischgestell ohne Platte

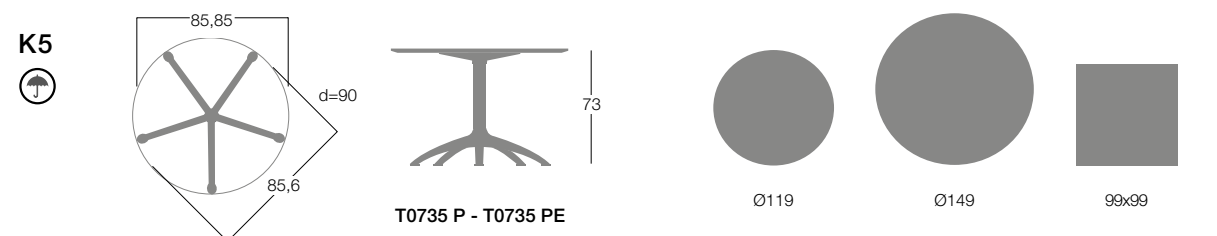
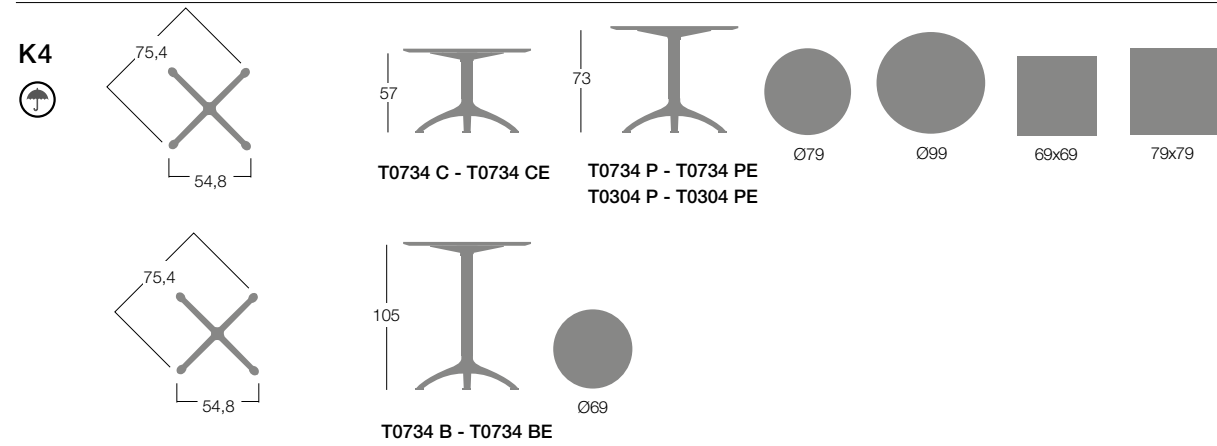
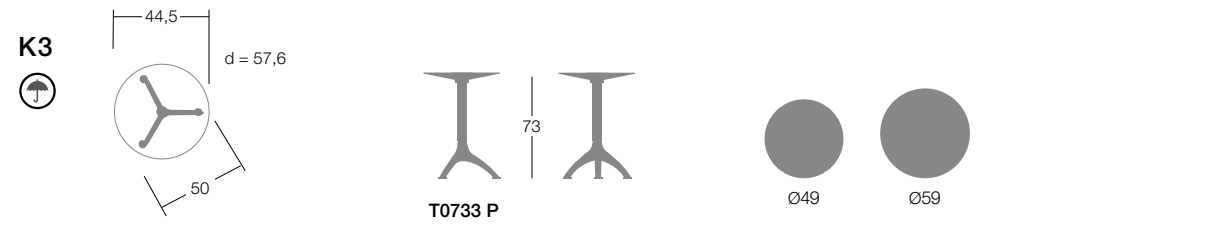
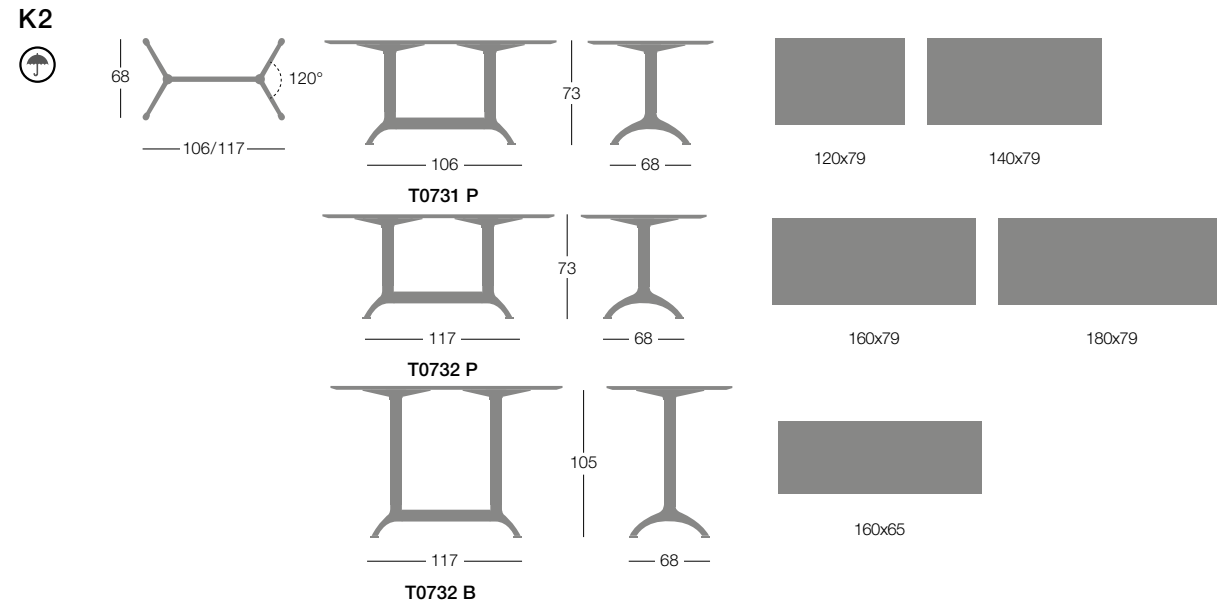

Finiture / Finishes / Finitions / Ausführungen

Struttura / Frame / Structure / Gestell

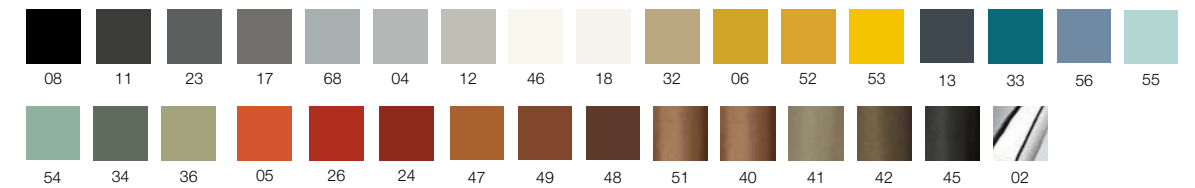

Piani tavolo / Table tops / Plateaux de table / Tischplatten

Nobilitato con bordo ABS / Melamine with ABS edge / Mèlaminé avec chants ABS / Melaminplatte mit ABS-Kante (**art. PNL**)
Spessore / Thickness / Epaisseur / Stärke: 25 mm

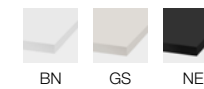

Laminato su truciolare bordo ABS / Laminate on chipboard with ABS edge / Stratifié sur aggloméré avec chants ABS / Laminat auf Spanplatte mit ABS-Kante (**art. PLT**)

Spessore / Thickness / Epaisseur / Stärke: 24 mm



HPL (**art. PHP**)

Spessore / Thickness / Epaisseur / Stärke: 10 mm



Lamiera verniciata / Powder coated steel / Acier laqué epoxy / Metall Epoxydlackiert (**art. PMT**)

Spessore / Thickness / Epaisseur / Stärke: 19 mm

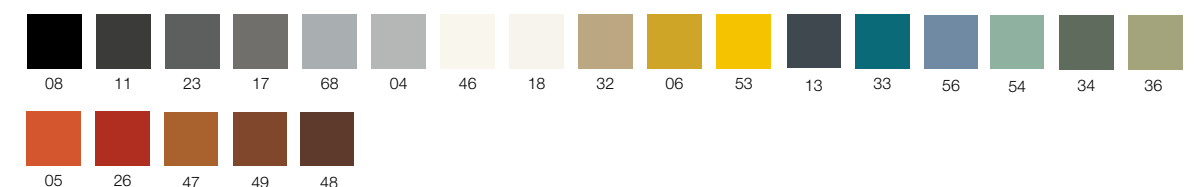





LONGWAY TABLE

Bartoli Design

Longway comprende una serie di tavolini in varie misure, da scegliere congiuntamente agli imbottiti della stessa collezione, oppure da utilizzare singolarmente. Sottili piani in laminato, in diversi colori e altrettanto snelle gambe, in cromo satinato, inox o verniciate, disegnano pezzi sinuosi e minimali, in grado di imprimere un tocco di unicità agli ambienti più diversi.

A series of low tables in various sizes, for individual use or as a joining element between Longway's benches. Thin HPL laminate tops in different colours and slender steel legs in powder coat, satin chrome, or brushed stainless, give a touch of uniqueness in numerous situations.

Longway est une famille de tables basses de différentes dimensions. Parfaitement cohérentes avec les modules d'assises rembourrés de la même collection, les tables peuvent aussi être utilisées seules. Son plateau stratifié est très fin, disponible en différentes couleurs, et ses pieds le sont tout autant, en finition chromé satiné, inox brossé ou époxy laqué. Ce côté minimaliste permet de mettre une touche d'originalité dans les projets.

Longway, eine Beistelltischserie in verschiedenen Größen, die man sowohl zu den Polstermöbeln, als auch Einzel gut einsetzen kann. Dünne Laminatplatten in verschiedenen Farben auf einem schlanken Gestell aus satiniertem Chrom, Edelstahl oder pulverbeschichteter Stahl. Minimalistische Objekte, die einzigartig wirken können.

* altezza tavolo piano escluso / base height without top / hauteur base hors plateau / Höhe Tischgestell ohne Platte

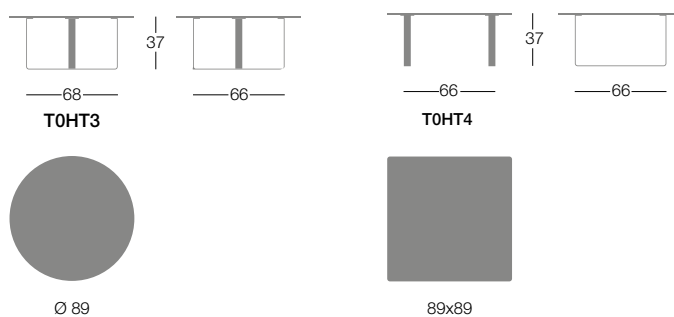
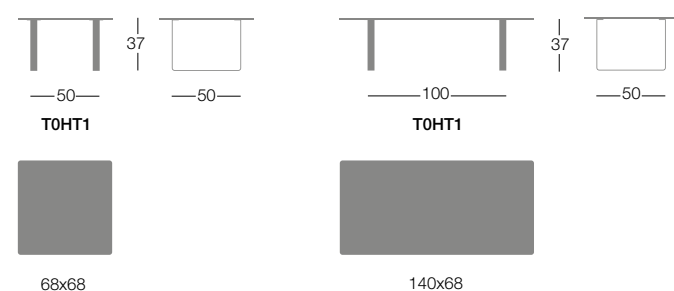

Finiture / Finishes / Finitions / Ausführungen

Struttura / Frame / Structure / Gestell

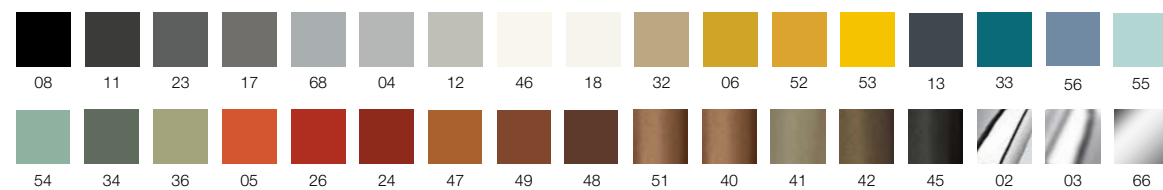

Piani tavolo / Table tops / Plateaux de table / Tischplatten

HPL (art. PHP)

Spessore / Thickness / Epaisseur / Stärke: 10 mm



NR*: nero anti-impronta / black anti fingerprint / noir anti-traces de doigts / Schwarz No-Print



LONGWAY TABLE



POLO

Archirivolto Design

Il tavolo Polo, realizzato in due differenti misure, si coordina alla sedia con la quale condivide i medesimi motivi decorativi che ricordano gli antichi merletti di pizzo. La colonna in alluminio e la base in fusione di ghisa garantiscono una assoluta stabilità. Un pezzo perfetto per gli ambienti esterni.

The Polo table, available in two different sizes, coordinates with the Polo chair; both have the same decorative motifs reminiscent of ancient laces. Aluminium column and cast-iron base guarantee absolute stability. Perfect for outdoor environments.

La structure de table Polo, disponible en deux dimensions, s'associe parfaitement à la chaise du même nom et ce par ses motifs décoratifs qui rappellent les anciennes dentelles. Sa colonne en aluminium et sa base en fonte garantissent une parfaite stabilité. Idéale pour les environnements extérieurs.

Der Tisch Polo ist in zwei Größen verfügbar, passend zu dem Stuhl Polo mit dem gleichen dekorativem Muster, das an antike Spitzkunst erinnern. Säule aus Aluminium und Fuss aus Aludruckguss, um Stabilität zu gewährleisten. Perfekt für Aussenbereiche.

* altezza tavolo piano escluso / base height without top / hauteur base hors plateau / Höhe Tischgestell ohne Platte

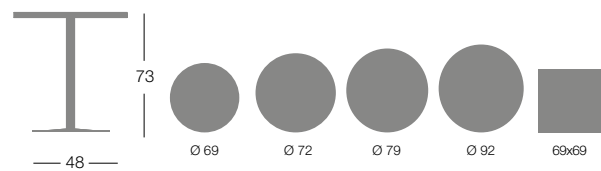

T0005 P - T0005 PE

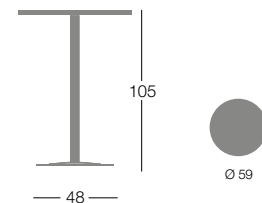

T0005 B - T0005 BE

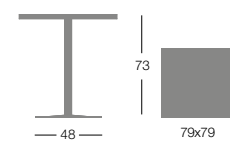

T0008 P - T0008 PE

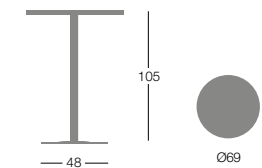

T0008 B - T0008 BE

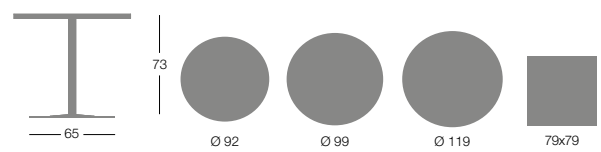

T0006 P - T0006 PE

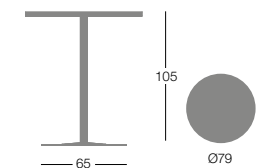

T0006 B - T0006 BE

Finiture / Finishes / Finitions / Ausführungen

Struttura / Frame / Structure / Gestell

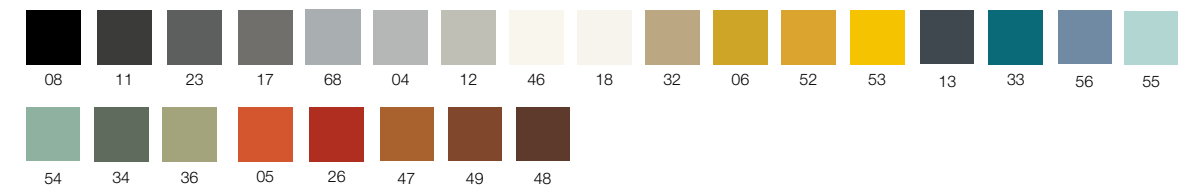

Piani tavolo / Table tops / Plateaux de table / Tischplatten

Nobilitato con bordo ABS / Melamine with ABS edge / Mé laminé avec chants ABS / Melaminplatte mit ABS-Kante (art. PNL)
Spessore / Thickness / Epaisseur / Stärke: 25 mm

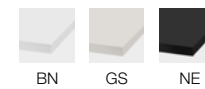

Laminato su truciolare bordo ABS / Laminate on chipboard with ABS edge / Stratifié sur aggloméré avec chants ABS
Laminat auf Spanplatte mit ABS-Kante (art. PLT). Spessore / Thickness / Epaisseur / Stärke: 24 mm



HPL (art. PHP)

Spessore / Thickness / Epaisseur / Stärke: 10 mm



Lamiera verniciata / Powder coated steel / Acier laqué epoxy / Metall Epoxydlackiert (art. PMT)

Spessore / Thickness / Epaisseur / Stärke: 19 mm

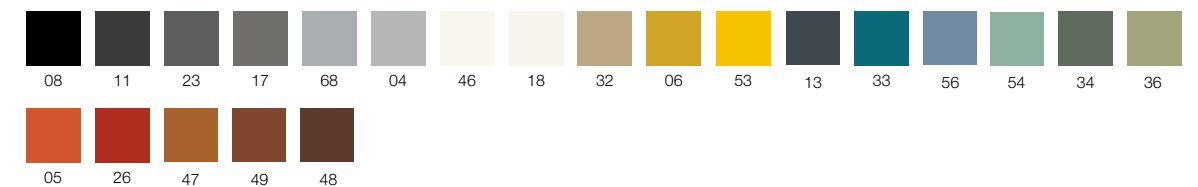





SAMU

Bartoli Design

Sistema di tavoli e tavolini per soddisfare tutte le esigenze in ambiente contract. Modelli diversi si compongono con basi centrali a quattro razze abbinabili a molteplici piani. Il design lineare delle basi, prodotte in tre altezze, è ottenuto con profili in acciaio verniciato a polveri in una gamma di svariati colori.

System of tables and low tables to meet all needs in the contract environment. Different models with either four-spoke or two-spoke bases can be combined with various tabletops. The linear design of the bases, available in three heights, are made in steel profile powder coated in a range of various colours.

Programme de tables, pour répondre à tous les besoins de l'environnement contract ou habitat. Samu a un piétement central à quatre branches à utiliser avec divers types de plateaux. Le design linéaire des bases, se décline en trois hauteurs, en profilé d'acier époxy laqué dans la totalité des coloris.

System von Tischen und Beistelltischen, um alle Bedürfnisse im Contract-Bereich zu erfüllen. Verschiedene Modelle fügen sich aus mittigen Basen mit vier Speichen zusammen, die mit unzähligen Platten kombiniert werden können. Das lineare Design der Basen, die in drei Höhen hergestellt werden, wird durch pulverbeschichtete Stahlprofile in einer Reihe von verschiedenen Farben.

* altezza tavolo piano escluso / base height without top / hauteur base hors plateau / Höhe Tischgestell ohne Platte

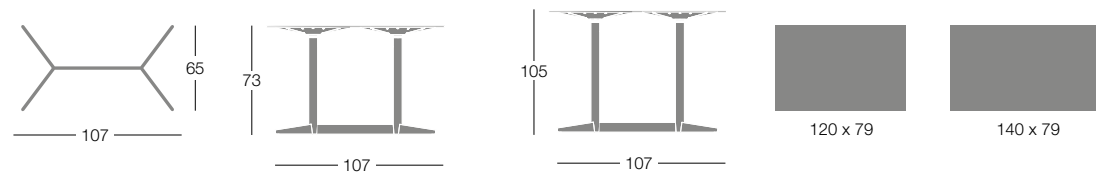

T0100 P

T0100 B

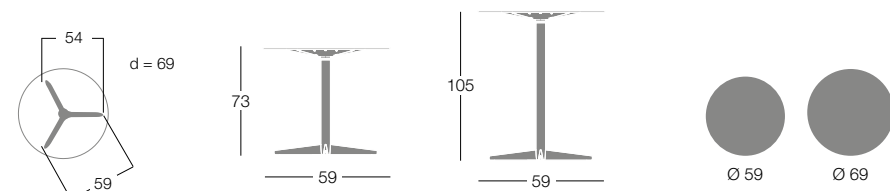

T0103 P

T0103 B

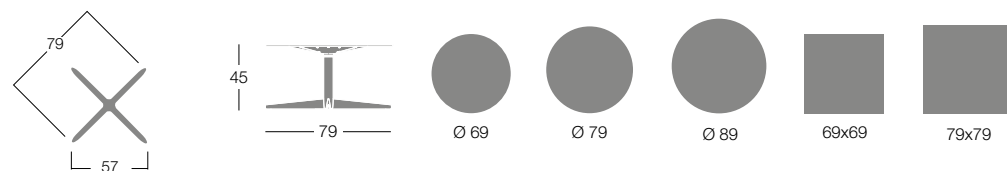

T0105 E

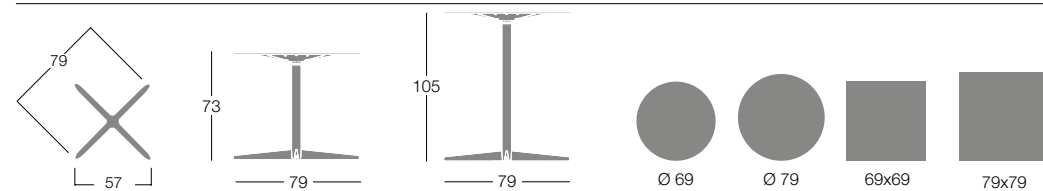

T0105 P

T0105 B

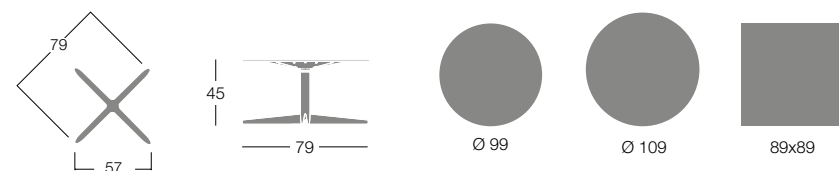

T0106 E

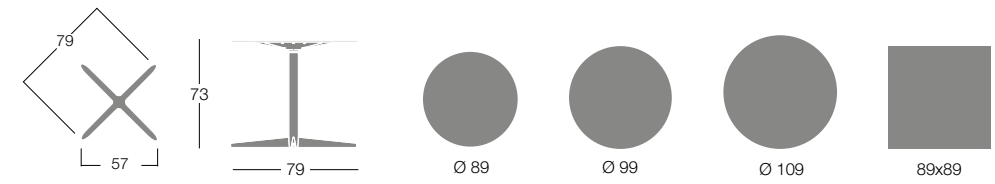

T0106 P

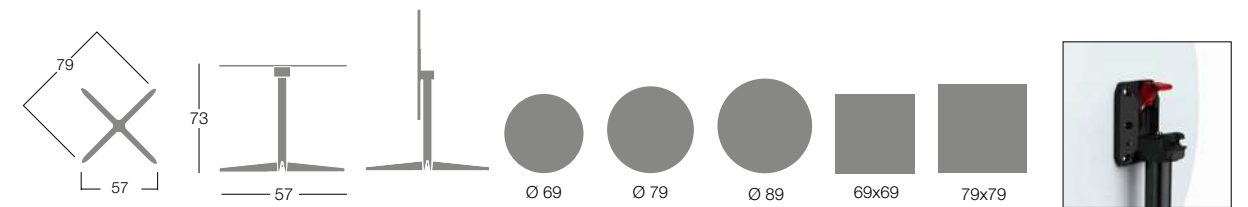

T0107 P

Con meccanismo ribaltabile / With folding mechanism / Disponible pied de table avec mécanisme rabattable / Version mit seitlich abklappbaren Tischplatten erhältlich

Finiture / Finishes / Finitions / Ausführungen

Struttura / Frame / Structure / Gestell

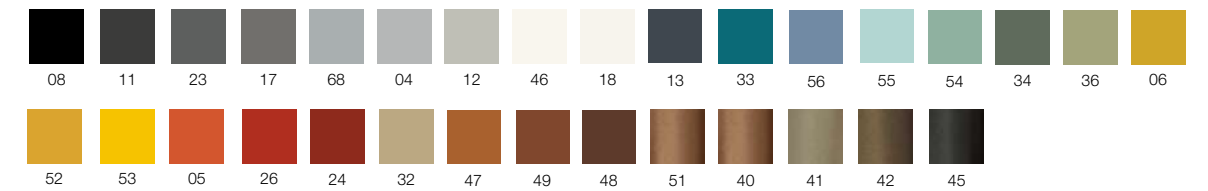

Piani tavolo / Table tops / Plateaux de table / Tischplatten

Nobilato con bordo ABS / Melamine with ABS edge / Mèlaminé avec chants ABS / Melaminplatte mit ABS-Kante (art. PNL)
Spessore / Thickness / Epaisseur / Stärke: 25 mm

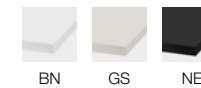

Laminato su truciolare bordo ABS / Laminate on chipboard with ABS edge / Stratifié sur aggloméré avec chants ABS
Laminat auf Spanplatte mit ABS-Kante (art. PLT). Spessore / Thickness / Epaisseur / Stärke: 24 mm

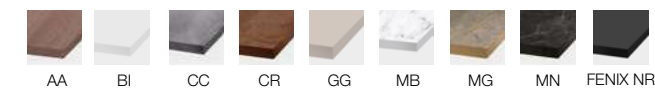

HPL (art. PHP)

Spessore / Thickness / Epaisseur / Stärke: 10 mm



Lamiera verniciata / Powder coated steel / Acier laqué epoxy / Metall Epoxydlackiert (art. PMT)
Spessore / Thickness / Epaisseur / Stärke: 19 mm

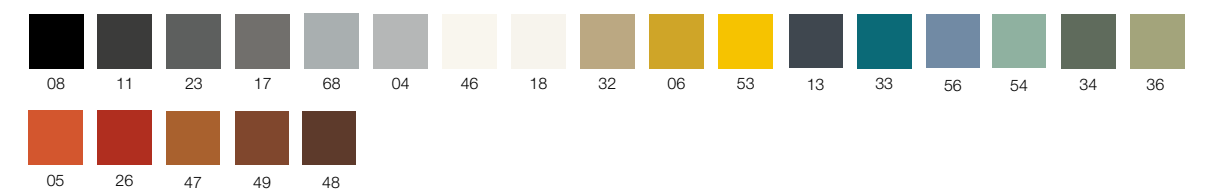





SLIM

UTS

Tavolo multifunzionale utilizzabile sia per applicazioni residenziali che contract, disponibile in 4 altezze. Le sue dimensioni sono particolarmente studiate come complemento di sedute imbottite o supporto portaoggetti multiuso. Struttura e piano in metallo disponibile in vari colori.

Multifunctional table usable for both residential and contract applications, available in 4 heights. Its dimensions are particularly studied as a complement to upholstered seating and a multipurpose holder stand. Metal frame and top available in several colours.

Table d'appoint disponible en 4 hauteurs, indiquée pour des environnements résidentiels ou bien contract. Ses dimensions s'adaptent parfaitement en complément d'assises rembourrées ou comme support polyvalent. Structure et plateau en métal disponibles en différentes finitions époxy laquées.

Multifunktionaler Tisch für Wohn- und Contract-Anwendungen, erhältlich in 4 Höhen. Seine Abmessungen sind besonders als Ergänzung zu gepolsterten Sitzen oder als Mehrzweck-Ablage konzipiert. Struktur und Platte aus Metall erhältlich in verschiedenen Farben.

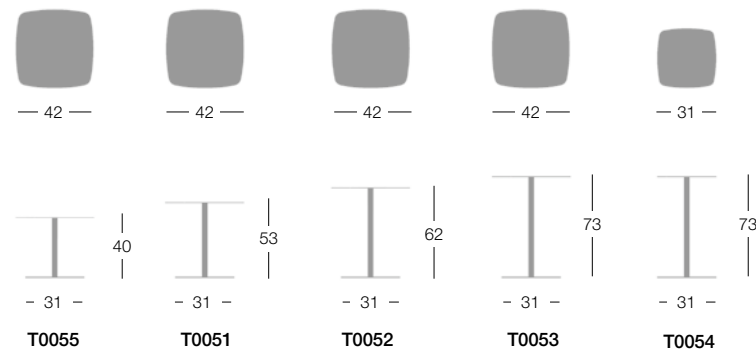

tavoli / tables / tables / Tische

Finiture / Finishes / Finitions / Ausführungen

Struttura / Frame / Structure / Gestell

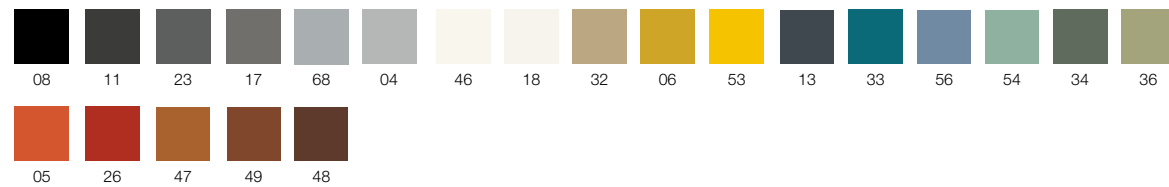

SLIM



STAY-ON

Archirivolto Design

Un gesto semplice, testimone di un'antica cultura, si rivela nelle geometrie primarie di una forma tanto minimale quanto riconoscibile, generata partendo dalla sezione dello stelo. Elemento verticale, in acciaio, lo stelo si adagia sui nastri incrociati alla base del tavolo. Disponibile a quattro razze con finitura verniciata in svariati colori per uso interno o esterno. Abbinabile a piani di varie misure e materiali in base alle diverse esigenze. Disponibile versione con meccanismo ribaltabile.

A simple hand, witness to an ancient culture, reveals itself in primary geometrics that are as minimal as they are recognizable. The upright steel column rests against the crossed strips at the table's base. 4 spoke base available in powder coated finish in several colours for indoor or outdoor. These work in combination with tabletops of different sizes and materials to accommodate a variety of needs. Available a version with folding mechanism.

Un geste simple, le témoin d'une culture ancienne, qui se révèle dans les géométries primaires de forme minimale, générées à partir de la section de la colonne. Élément vertical, en acier, la colonne repose sur les bandes croisées à la base de la table. Disponible en base étoile 4 branches, en version époxy laquée en différentes couleurs pour intérieur et extérieur. Plateaux disponibles en plusieurs matériaux et dimensions. Disponible version avec mécanisme rabattable.

Eine einfache Geste, Zeuge einer alten Kultur, zeigt sich in den primären Geometrien einer ebenso minimalen wie erkennbaren Form, die aus dem Querschnitt des Fußes erzeugt wird. Vertikales Element aus Stahl, der Fuß ruht auf den gekreuzten Bändern der Tischbasis. Erhältlich mit vier Speichen mit lackierter Oberfläche in verschiedenen Farben für den Innen- oder Außenbereich. Je nach Bedarf mit Platten in verschiedenen Größen und Materialien verfügbar. Version mit seitlich abklappbaren Tischplatten erhältlich.

* altezza tavolo piano escluso / base height without top / hauteur base hors plateau / Höhe Tischgestell ohne Platte

 T0110 E-T0111 E T0110 EE-T0111 EE	 T0110 P-T0111 P T0110 PE-T0111 PE	 T0110 B-T0111 B T0110 BE-T0111 BE	 T0112 P-T0113 P T0112 PE-T0113 PE	 T0114 P

Con meccanismo ribaltabile / With folding mechanism / Disponible pied de table avec mécanisme rabattable / Version mit seitlich abklappbaren Tischplatten erhältlich

Finiture / Finishes / Finitions / Ausführungen

Struttura / Frame / Structure / Gestell

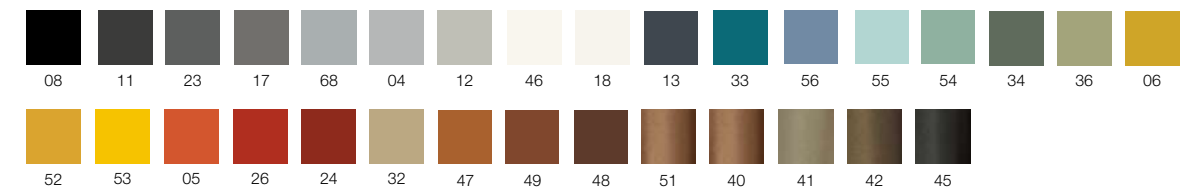

Piani tavolo / Table tops / Plateaux de table / Tischplatten

Nobilitato con bordo ABS / Melamine with ABS edge / Mèlaminé avec chants ABS / Melaminplatte mit ABS-Kante (art. PNL)
Spessore / Thickness / Epaisseur / Stärke: 25 mm

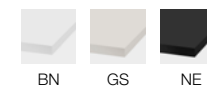

Laminato su truciolare bordo ABS / Laminate on chipboard with ABS edge / Stratifié sur aggloméré avec chants ABS
Laminat auf Spanplatte mit ABS-Kante (art. PLT). Spessore / Thickness / Epaisseur / Stärke: 24 mm

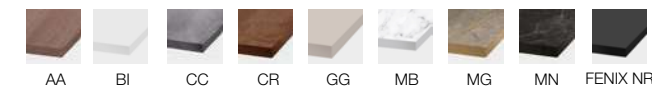

HPL (art. PHP)
Spessore / Thickness / Epaisseur / Stärke: 10 mm



Lamiera verniciata / Powder coated steel / Acier laqué epoxy / Metall Epoxydlackiert (art. PMT)
Spessore / Thickness / Epaisseur / Stärke: 19 mm

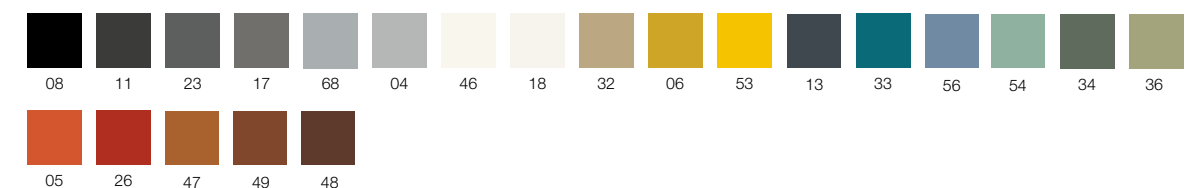



TIN-MAN

UTS

Tavolo multifunzionale utilizzabile sia per uso residenziale che contract disponibile in due altezze. Struttura e piano in metallo verniciato a polveri epossidiche.

Multifunctional table usable for both residential and contract applications, available in 2 heights. Frame and top in metal with powder coated finish.

Table d'appoint qui s'intègre aussi bien dans l'habitat que dans la collectivité. Structure et plateau en métal avec finition époxy laquée.

Beistelltisch in 2 Höhen erhältlich. Dieser Tisch passt sowohl ins Zuhause als auch in die Gemeinschaft. Gestell und Platte aus Stahl, epoxydlackiert.

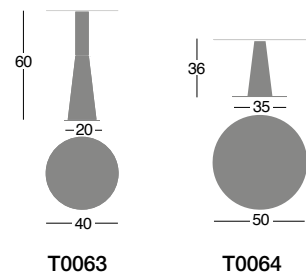

Finiture / Finishes / Finitions / Ausführungen

Struttura / Frame / Structure / Gestell

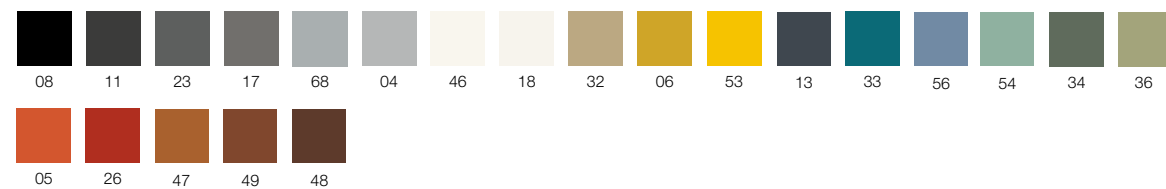

TOP&STOP

UTS

Con le sue forme armoniose ed ergonomiche, il tavolo Top & Stop è adatto per un arredamento interno ed esterno, prodotto con materiali di alta qualità, con forme pulite ed essenziali che contraddistinguono la sua sobrietà.

With its harmonious and ergonomic lines, Top & Stop table is suitable for indoor and outdoor use, produced in high quality materials, with clean and essential shapes that distinguish its sobriety.

Avec ses formes harmonieuses et ergonomiques, la table Top&Stop convient à l'aménagement d'intérieur et d'extérieur, réalisée avec des matériaux de qualité, aux formes épurées et essentielles qui caractérisent sa sobriété.

Mit seinen harmonischen und ergonomischen Formen eignet sich der Tisch Top&Stop für Innen- und Außenbereich, hergestellt aus hochwertigen Materialien, mit klaren und essenziellen Formen, die seine Nüchternheit charakterisieren.

* altezza tavolo piano escluso / base height without top / hauteur base hors plateau / Höhe Tischgestell ohne Platte

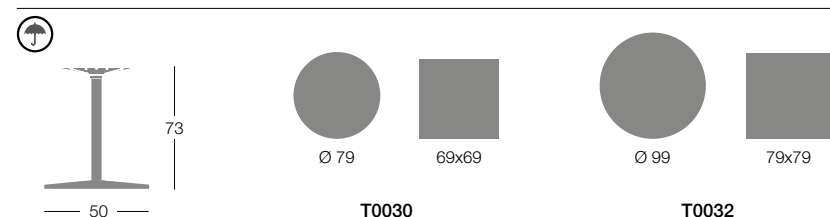

Piani tavolo / Table tops / Plateaux de table / Tischplatten

Nobilitato con bordo ABS / Melamine with ABS edge / Mélangé avec chants ABS / Melaminplatte mit ABS-Kante (art. PNL)
Spessore / Thickness / Epaisseur / Stärke: 25 mm

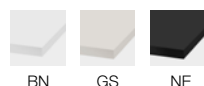

Laminato su truciolare bordo ABS / Laminate on chipboard with ABS edge / Stratifié sur aggloméré avec chants ABS /
Laminat auf Spanplatte mit ABS-Kante (art. PLT)
Spessore / Thickness / Epaisseur / Stärke: 24 mm

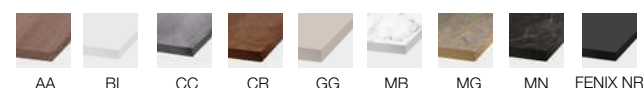

HPL (art. PHP)
Spessore / Thickness / Epaisseur / Stärke: 10 mm



Lamiera verniciata / Powder coated steel / Acier laqué epoxy / Metall Epoxydlackiert (art. PMT)
Spessore / Thickness / Epaisseur / Stärke: 19 mm

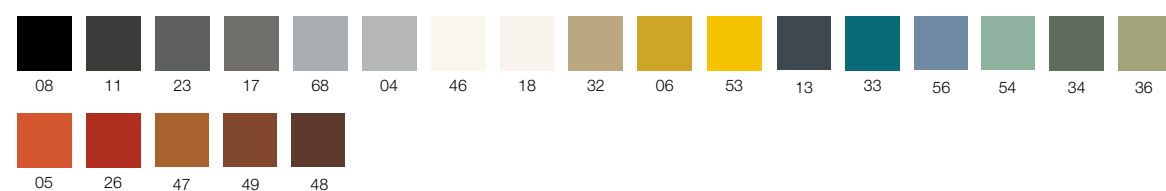

tavoli / tables / tables / Tische

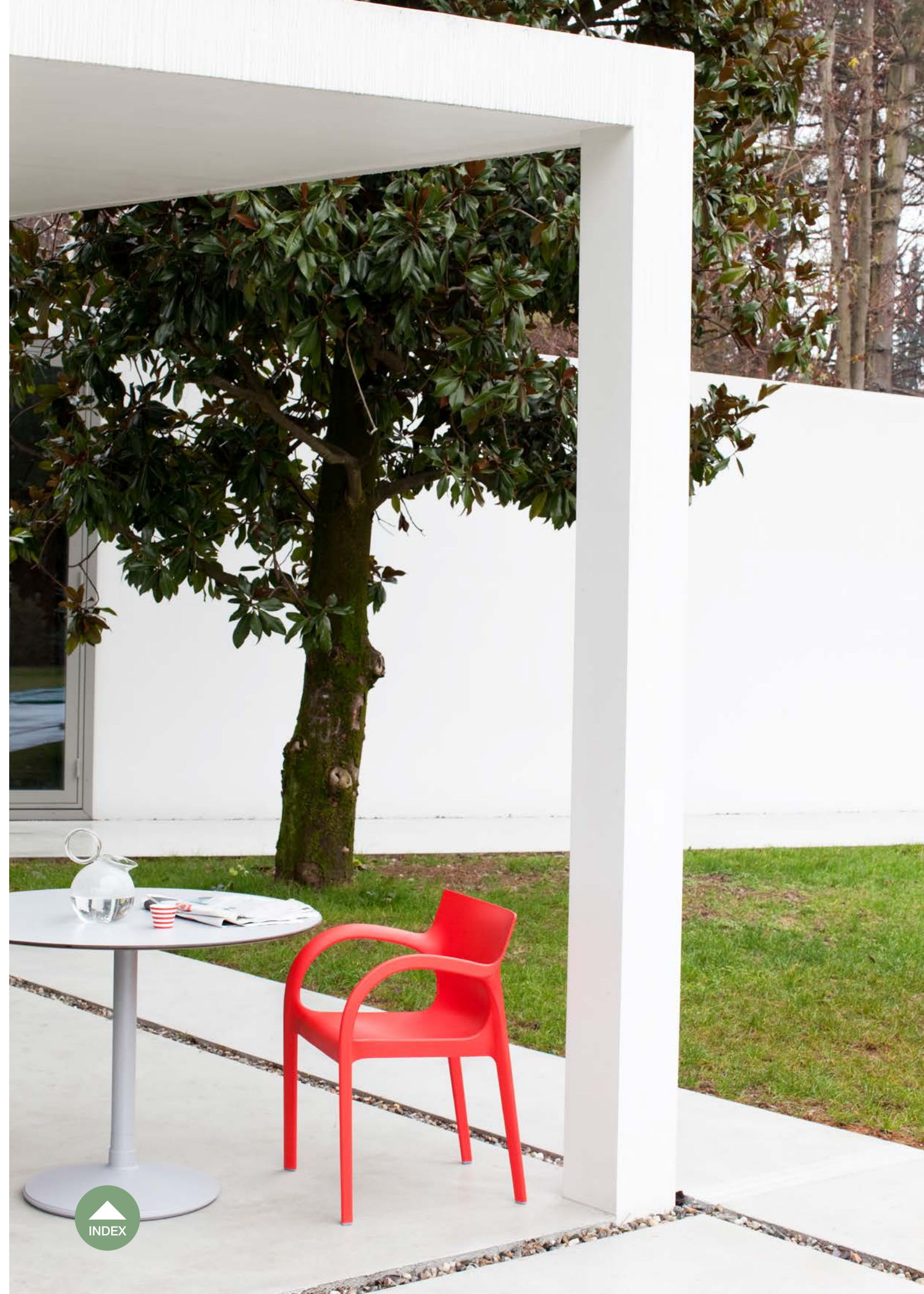



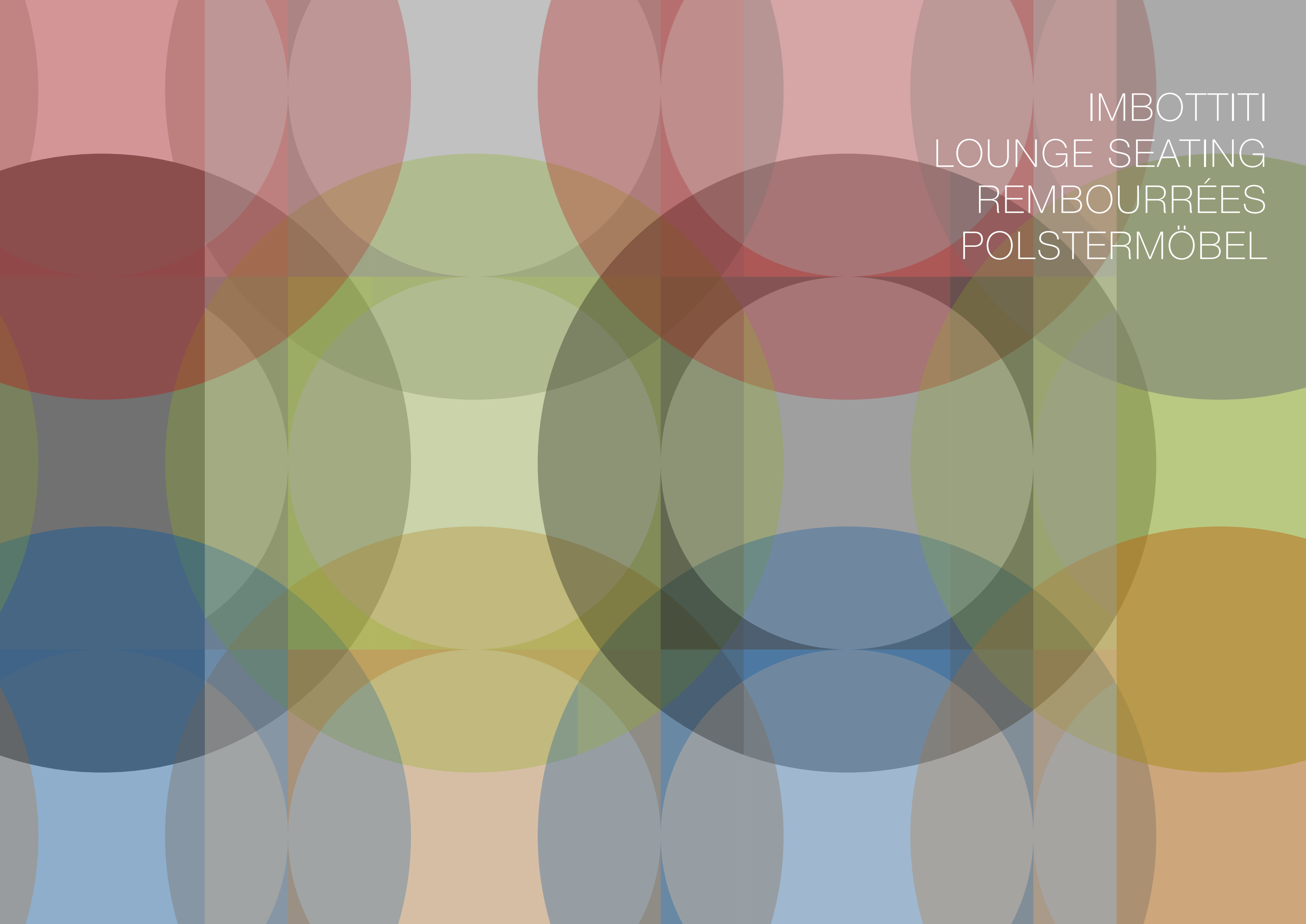

IMBOTTITI
LOUNGE SEATING
REMBOURRÉES
POLSTERMÖBEL

AGORÀ

Cisotti & Laube

Agorà, luogo della socialità per antonomasia, è l'idea che ispira questa collezione di elementi concepiti per trasformare i moderni spazi pubblici in ambienti di incontro. Molteplici imbottiti, dalla poltrona, al divano, al pouf con o senza ruote, ai tavolini per creare situazioni molto diverse tra loro, tutte accomunate dalla necessità di definire un ambiente capace di stimolare riflessioni e suggerire relazioni.

Agorà, the center of city's life, is the inspiring idea of an upholstered seating collection designed to transform modern public spaces in a meeting environment. Multiple pieces, from the armchair to the sofa, bench, ottoman (with and without castors) and tables create pleasurable environments by creating comfortable waiting and meeting spaces stimulating relationships.

Agorà, le lieu où se retrouver et partager le plaisir d'être ensemble, s'incarne dans une série de rembourrés qui réinterprètent l'idée de la zone lounge au travers de canapés, fauteuils, poufs et tables. Agorà est une sorte de microcosme où le partage des petites joies du quotidien. Devient possible comme une simple conversation en favorisant la convivialité.

Agorà. Mitten im Leben, ist die Idee eine Polsterkollektion zu entwerfen, die moderne öffentliche Räume in private Treffpunkte verwandelt. Sessel, Sofa, Hocker mit Tischen schaffen angenehme Warte- und Treffpunkte.

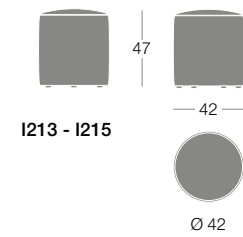
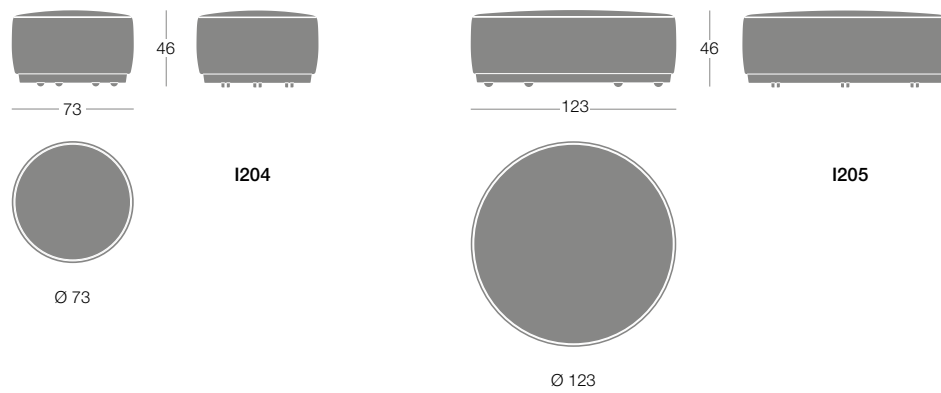
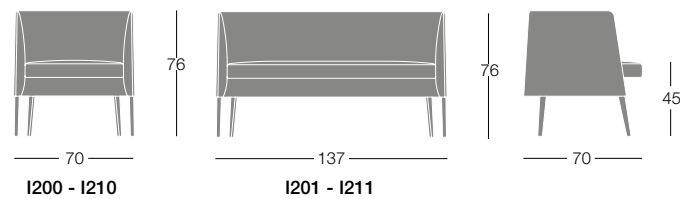

Finiture / Finishes / Finitions / Ausführungen

Struttura / Frame / Structure / Gestell

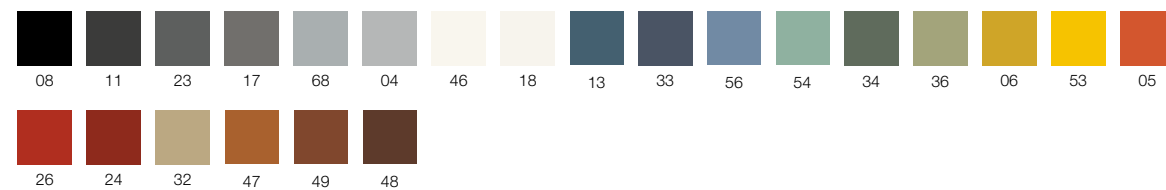

Struttura cromata / Chromed frame / Structure chromée / Gestell Verchromt



02

Legno / Wood / Bois / Holz



FA 02







ALPHABET COLLECTION

ALPHABET - DTA

Roberto Romanello

Alphabet Collection include poltrone e divani. Realizzati con una struttura in acciaio che si coniuga al poliuretano indeformabile della seduta presentano finiture che spaziano da materiali e tinte più eleganti a proposte più fresche e colorate.

Alphabet Collection includes armchairs and sofas. Each piece is made of solid materials, such as an internal steel frame and cold-injected polyurethane foam. Available in a variety of finishes from the more elegant to the fresh and colourful proposals.

Alphabet Collection fauteuils et canapés. Tous les éléments sont réalisés avec des matériaux solides, comme la structure en acier et l'assise en mousse de polyuréthane indéformable et les finitions peuvent être des plus sobres et sérieuses mais aussi plus fraîches et colorées.

Alphabet Collection besteht aus einem Sessel und Sofa. Jedes Stück ist aus robustem Material, wie Stahlstruktur und kaltgeschäumter Polyurethanschaum. Verfügbar in verschiedenen Ausführungen mit eleganten bis hin zu farbigen Materialien.

DTA

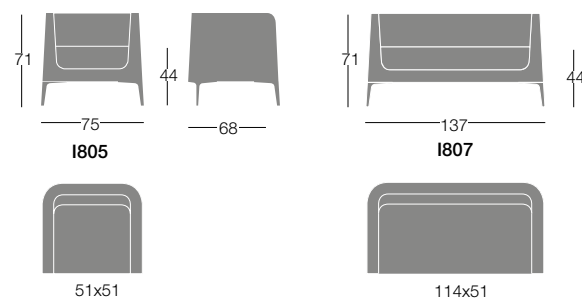

OMG

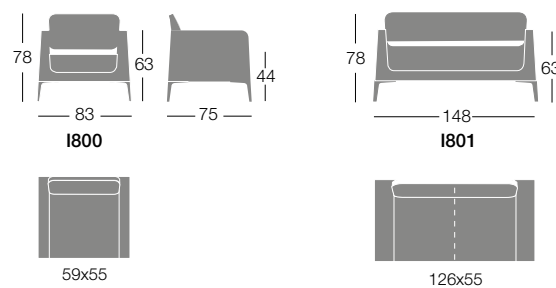

Versione in pelle con cucitura centrale
Leather version with central stitching
Version cuir avec couture centrale sur l'assise
Lederausführung mit Mittelnaht im Sitz

Finiture / Finishes / Finitions / Ausführungen

Struttura / Frame / Structure / Gestell

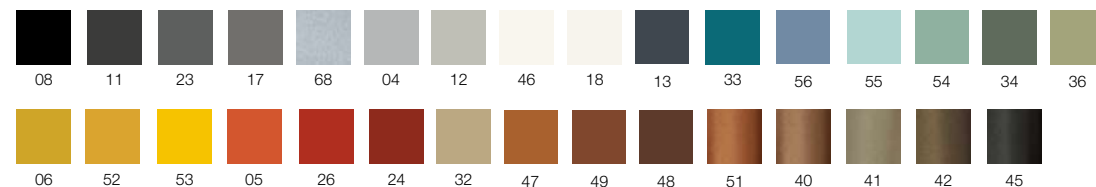

Struttura cromata / Chromed frame / Structure chromée / Gestell Verchromt



imbottiti / lounge seating / rembourrés / Polstermöbel









Melbourne Convention Centre, Melbourne, Australia



BE-ON

Archirivolto Design

La modularità infinita del sistema di poltrone e divani Be-On è la quintessenza dell'ospitalità. Si compone a piacimento creando spazi di molteplici dimensioni e forme, spazi che possono essere arginati da barriere o completamente liberi. Seduta, schienale e pannelli in diverse altezze creano un senso di intimità, accogliendo al loro interno una o più persone, che possono lavorare, condividere idee o semplicemente rilassarsi.

The infinite modularity of the Be-On system of armchairs and sofas is the quintessence of hospitality. Easy to compose, it creates spaces of multiple dimensions and shapes, dammed by barriers or completely free. Seat, backrest and panels in different heights create a sense of intimacy, welcoming one or more people, who can work, share ideas or simply relax.

La modularité infinie du système de fauteuils et canapés Be-On est la quintessence de l'hospitalité. Il se compose à volonté, créant des espaces de tailles et de formes multiples, des espaces qui peuvent être encaissés par des barrières ou totalement libres. L'assise, le dossier et les panneaux de différentes hauteurs créent un sentiment d'intimité, accueillant une ou plusieurs personnes à l'intérieur, qui peuvent travailler, partager des idées ou simplement se détendre.

Die unendliche Modularität des Sessel- und Sofasystems Be-On ist die Quintessenz der Gastfreundschaft. Es kann nach Belieben komponiert werden und Räume in verschiedenen Größen und Formen schaffen, Räume, die durch Barrieren eingeschlossen oder völlig frei sein können. Sitz, Rückenlehne und Paneele in unterschiedlichen Höhen schaffen ein Gefühl der Intimität und heißen eine oder mehrere Personen in ihrem Inneren willkommen, die arbeiten, Ideen austauschen oder einfach nur entspannen können.





BILLA LOUNGE

Favaretto & Partners

La sensazione di comfort che dona la poltroncina Billa è immediata. Contraddistinta da uno schienale in multistrato di rovere curvato, Billa avvolge il corpo, restituendo una sensazione di calore e piacevolezza, grazie ai pannelli imbottiti, rivestiti in tessuto o in pelle.

The feeling of comfort that the Billa armchair inspires is immediate. Characterized by its curved oak plywood backrest, Billa wraps you in a feeling of calm warmth guaranteed thanks to the padded panels upholstered in fabric or leather.

La sensation de confort donnée par le fauteuil Billa est instantanée. Avec son dossier en contreplaqué chêne, le fauteuil Billa vous enveloppe dans une sensation de chaleur et de confort grâce aux panneaux rembourrés recouverts de tissu ou de cuir.

Der sessel Billa stahlt unmittelbar ein Gefühl von Komfort aus. Die Rückenlehne aus gebogenem Eichenschichtholz zeichnet das Modell aus. Dank den Polsterkissen aus Stoff oder Leder umarmt Billa und gibt ein Gefühl der Wärme.

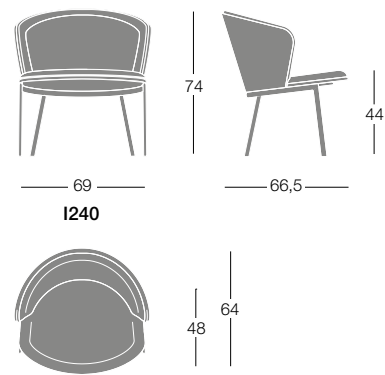

imbottiti / lounge seating / rembourrés / Polstermöbel

Finiture / Finishes / Finitions / Ausführungen

Struttura / Frame / Structure / Gestell

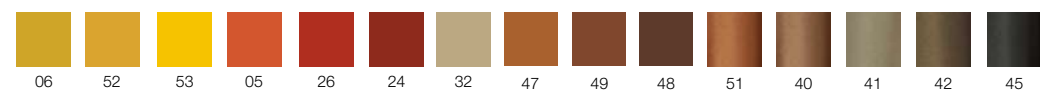
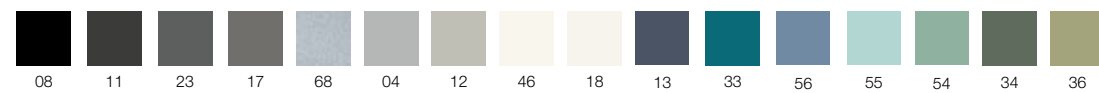

Struttura cromata / Chromed frame / Structure chromée / Gestell Verchromt



02

Legno / Wood / Bois / Holz







CARELL

Alejandro Valdès

Poltrona e Divano 2/3 posti, disponibili in due varianti schienale. Collezione dal forte carattere grafico, essenziale nelle linee, ma dall'aspetto sofisticato, indicata per ambienti healthcare e spazi lavorativi. Struttura in profilato di tubo di acciaio ovale verniciato a polveri epossidiche e braccioli in legno massello rovere.

Armchair and Sofa 2/3 seats, available with two different type of backrest. Collection with a strong graphic character, essential in the lines, but with a sophisticated appearance, suitable for healthcare environments and working spaces. Frame in oval steel tube profile with powder coated finish and armrests in oak solid wood.

Fauteuil et canapé 2/3 places, avec deux variantes de dossier. Collection au fort caractère graphique, essentiel dans les lignes, mais à l'apparence raffinée, adaptée aux environnements médicaux et aux espaces de travail. Structure en profilé de tube d'acier ovale avec finition époxy laquée et accoudoirs en bois de chêne massif.

Sessel und 2-3 Sitzersofa, mit zwei Rückenlehnenvarianten. Kollektion mit starkem grafischen Charakter, essenziell in den Linien aber mit einem raffinierten Look. Geeignet für Gesundheitswesen und Arbeitsräume. Gestell aus pulverbeschichtetem ovalem Stahlrohrrahmen und Armlehnen aus massiver Eiche.

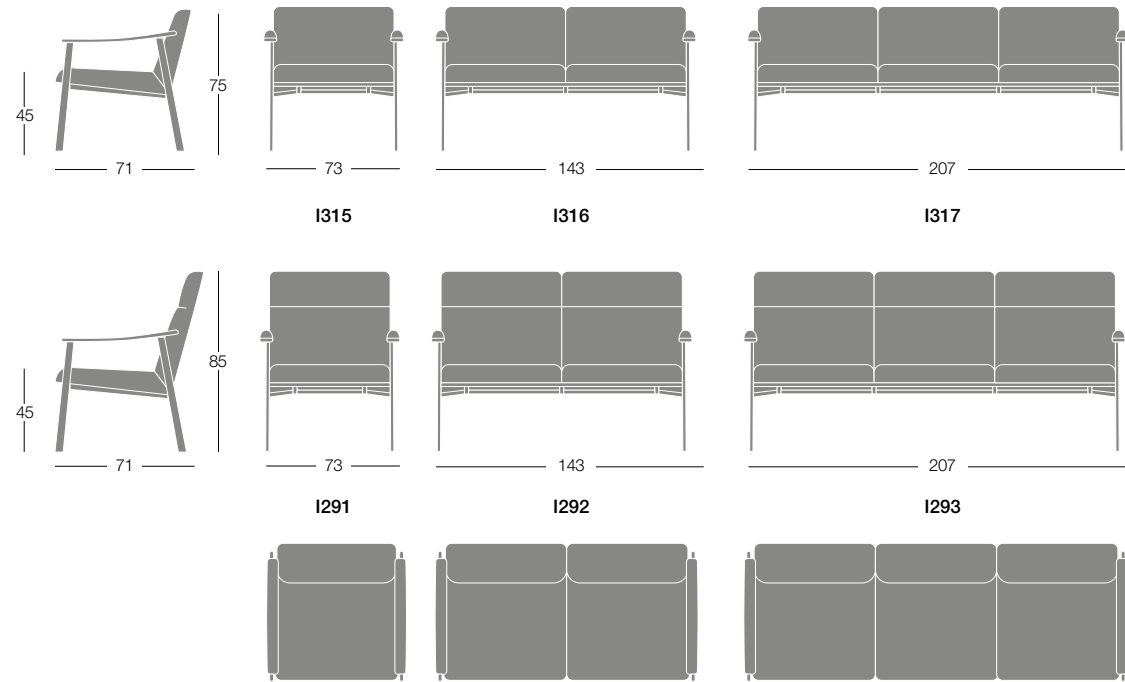

Finiture / Finishes / Finitions / Ausführungen

Struttura / Frame / Structure / Gestell

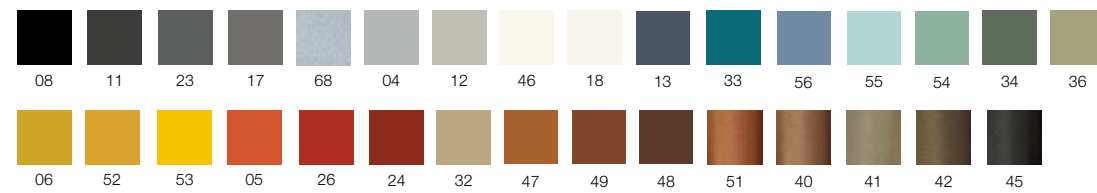

Legno / Wood / Bois / Holz

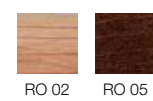





CARELL
schienale alto / high back / dossier haut / hoher Rückenlehne



CROSS

Archirivolto Design

Contrassegnata dal contrasto fra le linee severe della scocca e le sinuosità dell'imbottitura, Cross è una proposta di imbottiti composta da divano e poltrona, capace di valorizzare qualsiasi ambiente con un'impronta contemporanea e dal fascino internazionale. Non solo charme e cura dei dettagli, ma anche praticità, grazie ad una struttura interna in metallo e poliuretano indeformabile e alle gambe in fusione di alluminio, verniciate o cromate. I rivestimenti sono disponibili in tessuto, in ecopelle o in pelle.

A family of a contemporary lounges characterized by a rigorous shellcombined with cushions and sinuous lines. The collection includes lounge armchair and sofa able to enhance any environment. Cross not only has charm but also functionality with an internal steel frame covered with non-deformable foam and polyester padding plus die-cast aluminium legs in powder coat or chrome. Covers in fabric, faux leather or leather.

Cross est une famille d'assises rembourrés, qui comprend un canapé et un fauteuil lounge. Sa structure rigoureuse est adoucie par ses coussins et ses lignes sinueuses. Cross apporte un plus dans n'importe quel environnement. La gamme possède un charme indéniable et elle n'en demeure pas moins pratique grâce à sa structure en métal et sa mousse de polyuréthane, ses piétements en aluminium époxy laqué ou chromé. En tissu, cuir ou simili-cuir.

Eine strenge Form mit weicher Polsterung, Cross ist ein Allround Sessel mit internationalem Charme, passend zu jedem Ambiente, nicht nur durch Charme, sondern auch durch ihre Zweckmäßigkeit. Gestell lackiert oder verchromt, Sitz aus geformtem Polyurethan mit verschiedenen Materialien überzogen.

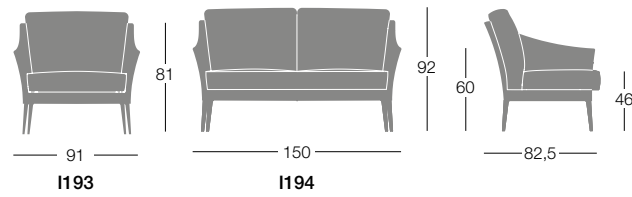

imbottiti / lounge seating / rembourrés / Polstermöbel

Finiture / Finishes / Finitions / Ausführungen

Struttura / Frame / Structure / Gestell

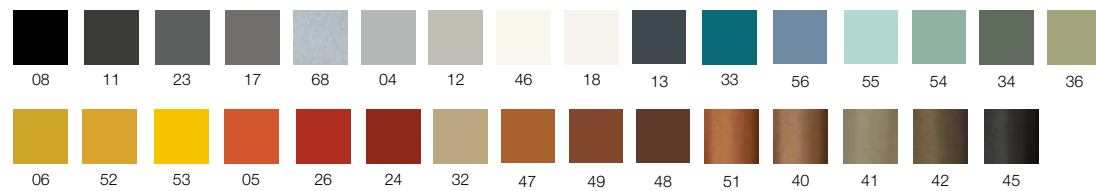

Struttura cromata / Chromed frame / Structure chromée / Gestell Verchromt





Médiathèque Jean D'Ormesson, Le Plessis-Robinson, France





FLORES

Bartoli Design

Grazie alle sue forme regolari e morbide, Flores stimola sensazioni di curiosità e un piacevole senso di comfort. Ideale per spazi destinati all'attesa e all'incontro, si presenta come un singolo imbottito, contraddistinto da infinite possibilità di seduta, grazie al suo disegno accessibile da ogni lato e ai cuscini liberamente adattabili ma sempre stabili.

With its regular and soft shapes, Flores is an appealing piece capable of exciting curiosity. It is perfect for waiting areas and meeting places. A product with endless seating possibilities thanks to its design that allows one to sit on any side and to arrange the cushions comfortably.

Flores, avec ses formes régulières et douces, a un aspect à la fois intrigant et rassurant. Destinée aux espaces d'attente ou de rencontre, ses capacités d'assises, se démultiplient à l'infini grâce à son design qui permet une utilisation totale de l'assise, d'un côté comme de l'autre, et ses coussins amovibles ou solidaires de la structure.

Flores mit gut definierten und weichen Formen erweckt Neugier und Zuversicht zugleich. Ideal für Wartebereiche und Treffpunkte. Ein Produkt mit endlosen Sitzmöglichkeiten durch die Möglichkeit einseitig oder beidseitig zu sitzen und die frei positionierbaren Kissen.

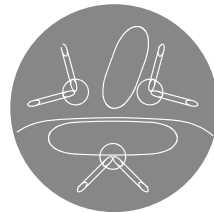

Ø 200

IF01 - IF05

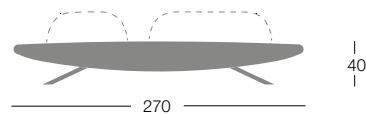

270

40

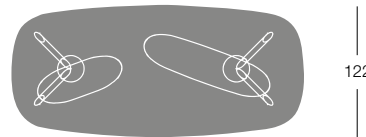

270

122

IF02 - IF06



80x33xh.27

IF01 - IF03



120x33xh.27

IF04 - IF06

Finiture / Finishes / Finitions / Ausführungen

Struttura / Frame / Structure / Gestell

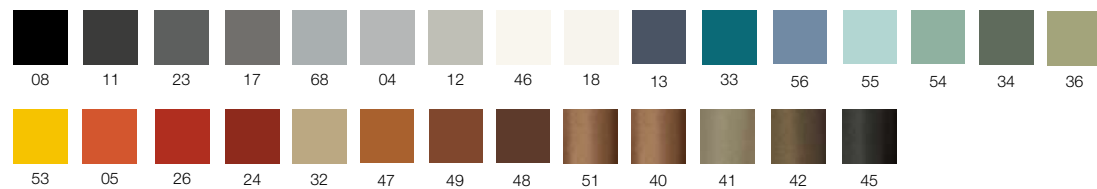

Struttura cromata / Chromed frame / Structure chromée / Gestell Verchromt



02

imbottiti / lounge seating / rembourrées / Polstermöbel





ABC Grand Cinema, Beirut, Lebanon



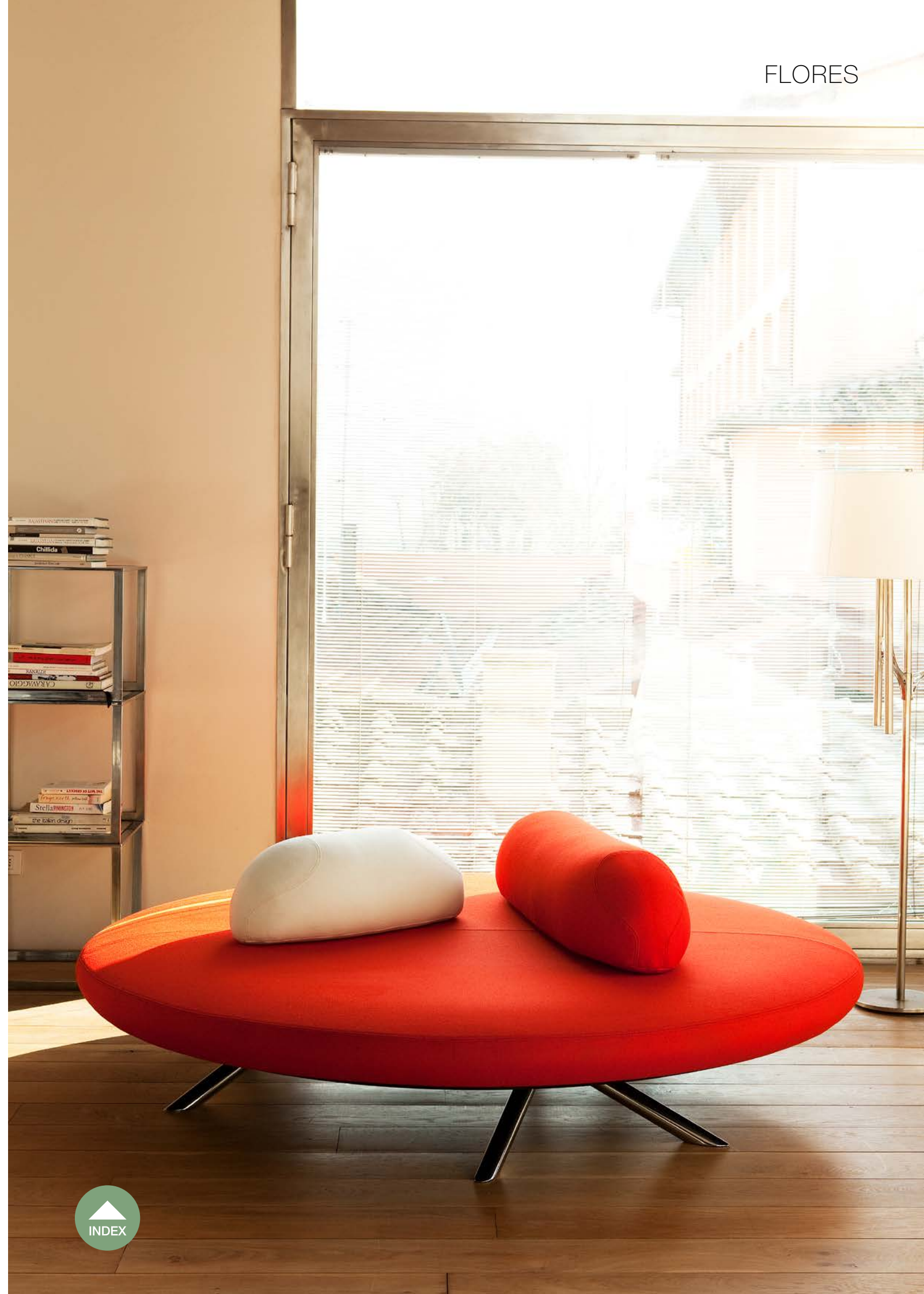

HAMMER-M/L

Favaretto & Partners

Il giunto in alluminio pressofuso che unisce gambe anteriori e struttura circolare, crea un dettaglio di un tale impatto formale da ispirare il nome di un'intera collezione di sedute. Hammer è, infatti, una poltrona lounge, con schienale alto o basso. Nelle sue varianti dimensionali e di finiture risulta perfetta per gli ambienti più diversi, dalla casa al contract, dalla camera d'albergo alla sala riunioni. Un elemento di grande eleganza adatto ad ogni situazione.

A die-cast aluminum element joins the front legs and circular structure; a detail that for its originality and appeal inspires the name of the collection. The Hammer lounge chair is available with a low or high back thus fulfilling synergistic needs. Its variety makes it perfect for any environment, from contract to home, from hotel room to meeting room... elegant in every situation.

Un joint en aluminium moulé sous pression relie les pieds avant et la structure circulaire, et la puissance d'évocation de ce détail (en forme de marteau) donne son nom à la collection toute entière. Élégant en toutes situations, Hammer est un fauteuil lounge avec dossier bas ou haut, et qui par ses nombreuses dimensions et finitions s'intègre dans tous les espaces: du résidentiel le plus classique à l'environnement contract et tertiaire des plus exigeants.

Auf das Detail kommt es an Ein Element aus Aludruckguss verbindet Vorderbeine mit der runden Struktur; ein Detail in markanter Form, das einer ganzen Kollektion den Namen gibt. Hammer ist ein kleiner Sessel, der in vielfältigen Ausführungen perfekt in verschiedene Umgebungen passt. Für Heim und Objekt, für Hotelzimmer bis hin zum Besprechungsraum. Elegant in jeder Situation.

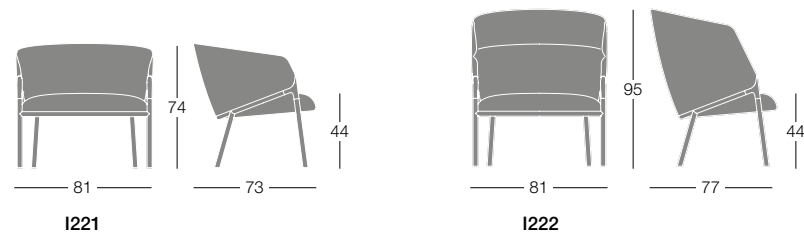

imbottiti / lounge seating / rembourrés / Polstermöbel

Finiture / Finishes / Finitions / Ausführungen

Struttura / Frame / Structure / Gestell

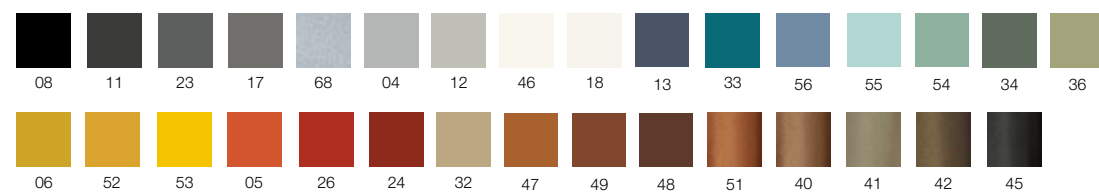

Struttura cromata / Chromed frame / Structure chromée / Gestell Verchromt





West Gippsland Art Centre, Victoria, Australia







HOTEL

Cisotti & Laube

Hotel è un sistema di imbottiti caratterizzato da una forte versatilità espressiva, nato per dar vita a combinazioni fluide, lineari o angolari. Una proposta di sedute poliedriche che si snodano nello spazio all'insegna della massima personalizzazione. Oggetti dal taglio impeccabile per assaporare pienamente il relax, ma al contempo aperti all'incontro e all'emozione della convivialità. Si compone di un divano da due o tre posti e una poltrona con tre tipologie di braccioli: bracciolo imbottito in due varianti (7 e 14 cm) e bracciolo tavoletta per l'uso del computer o altro. Tavolini di raccordo e tavolini di appoggio completano la collezione.

Hotel is a modular seating system characterized by a strong expressive versatility conceived for fluid, linear and angular combinations. Comfortable pieces designed for enjoyable relaxation and conviviality. The collection includes two and three seater sofas plus an armchair; armrest options include an upholstered armrest in two sizes (7- 14 cm) and a tablet arm for computer or other support. Joining tables between the seats or multifunctional tables complete the collection.

Hôtel est un système d'assises rembourrées très polyvalent qui offre de multiples combinaisons en linéaire mais aussi en angle. Le produit peut donc être personnalisé à l'infini. Son design parfait permet à la fois de se détendre sans être dérangé mais aussi de rester ouvert aux rencontres et de créer de la convivialité. Le système se compose d'un fauteuil et d'un canapé deux ou trois places avec des accoudoirs rembourrés en deux variantes (7-14 cm) ou des tablettes-accoudoirs servant d'appui pour poser un ordinateur ou autre. La collection est également enrichie de tables de connexion et de tables d'appoint.

Hotel ist ein Modulare System mit einem starkem Ausdruck in der Vielfalt, entworfen um Zusammenstellungen über Eck oder gerade zu ermöglichen. Objekte vom tadellosem Design, um Relaxmomente zu genießen, auch für Treffpunktbereiche geeignet. Es besteht aus einem Sofa, 2-sitzer oder 3-sitzer und einem Sessel mit drei Armlehnvarianten: (7 und 14 cm) und eine Armauflage für Tablet oder PC. Tischablagen zwischen den Elementen und Multifunktions-tische ergänzen diese Kollektion.

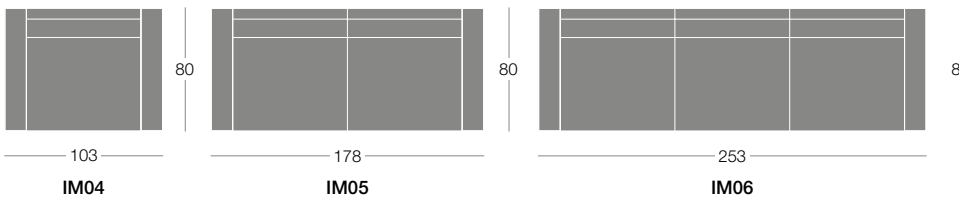
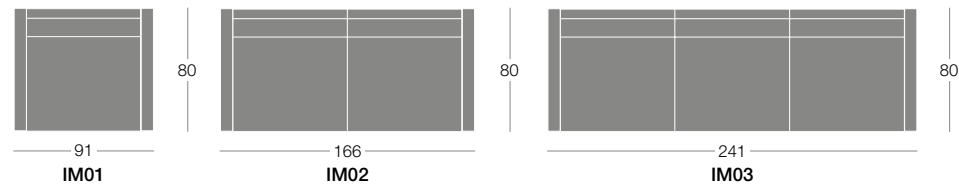
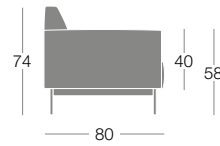

Finiture / Finishes / Finitions / Ausführungen

Struttura / Frame / Structure / Gestell

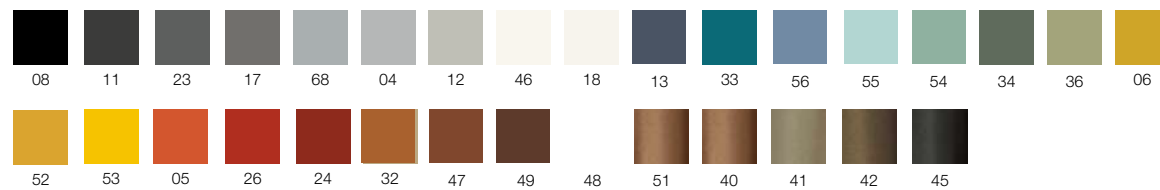

Bracciolo tavoletta / Tablet arm / Tablette-accoudoir / Tablet-Arm

Laminato su truciolare bordo ABS / Laminat on chipboard with ABS edge
Stratifié sur aggloméré avec chants ABS / Laminat auf Spanplatte mit ABS-Kante (art. PLT)
Spessore / Thickness / Epaisseur / Stärke: 24 mm



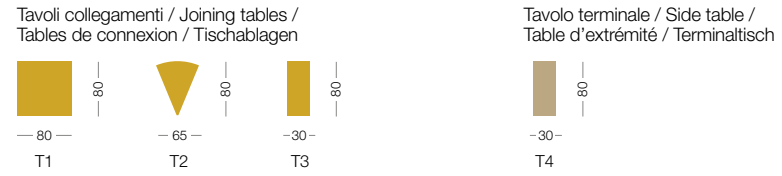
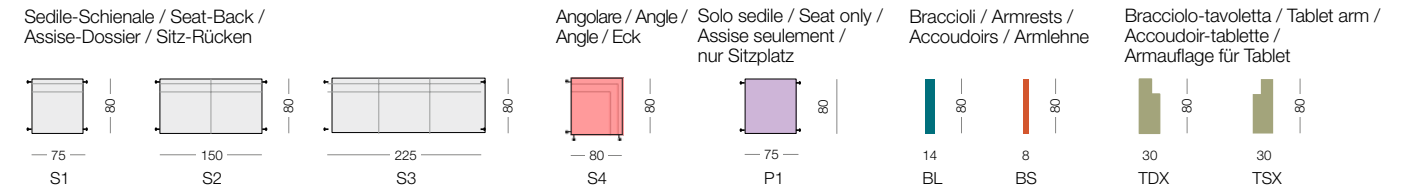
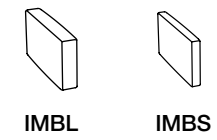
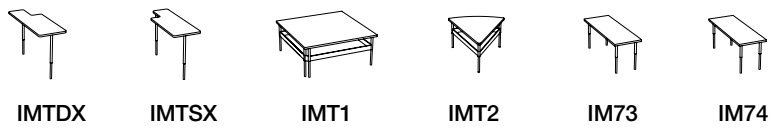
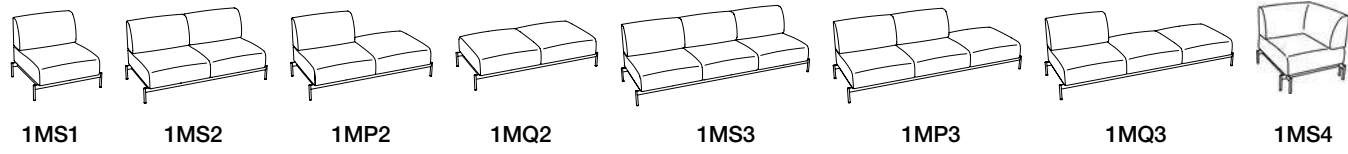
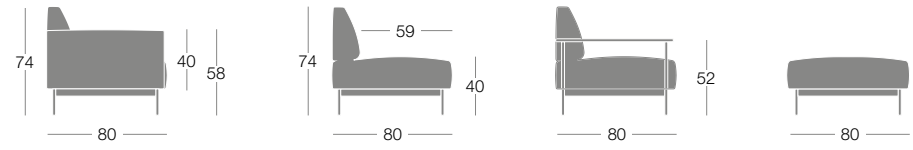

Esempi di composizioni / Composition examples / Exemples de compositions / Beispiele

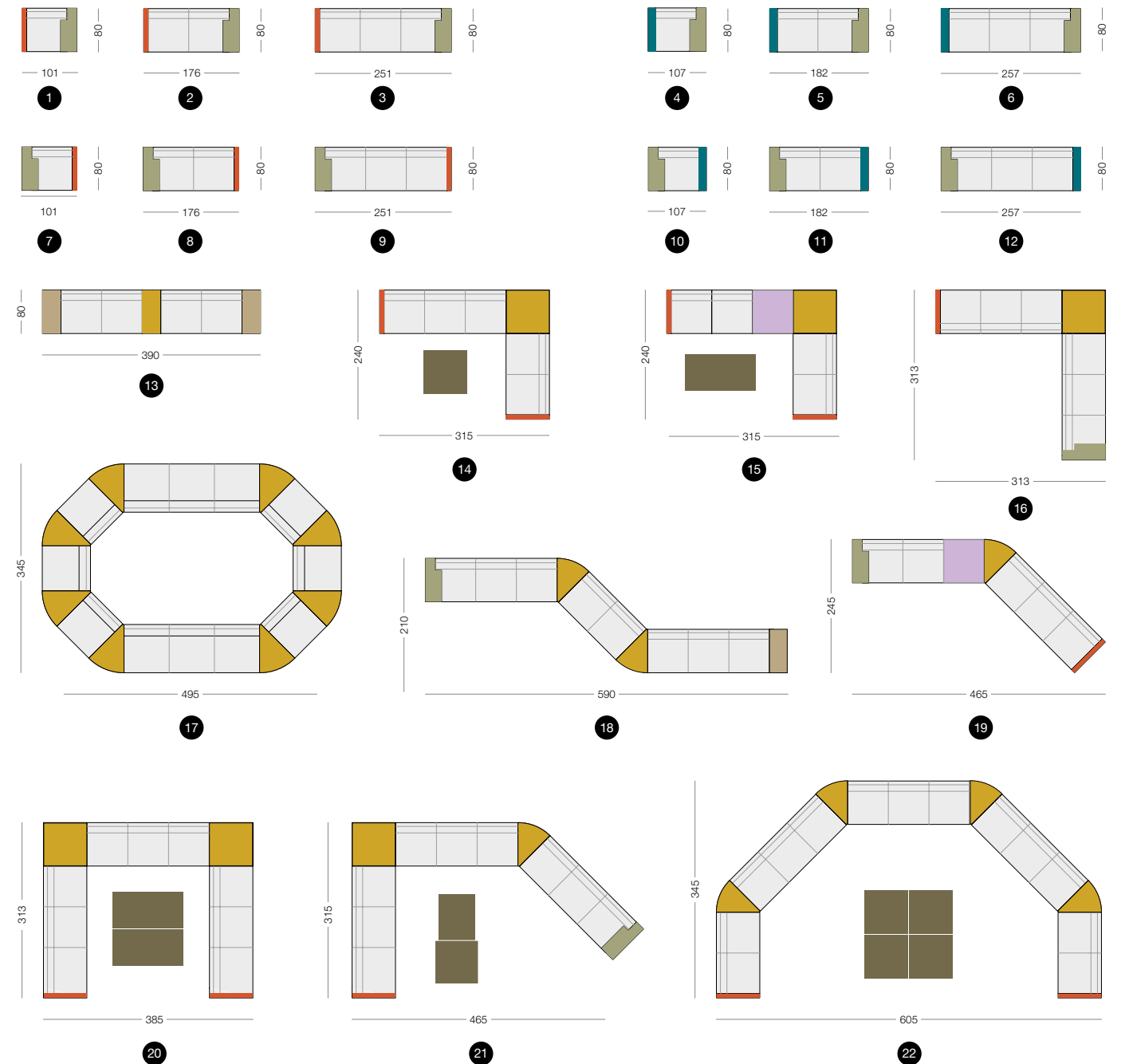





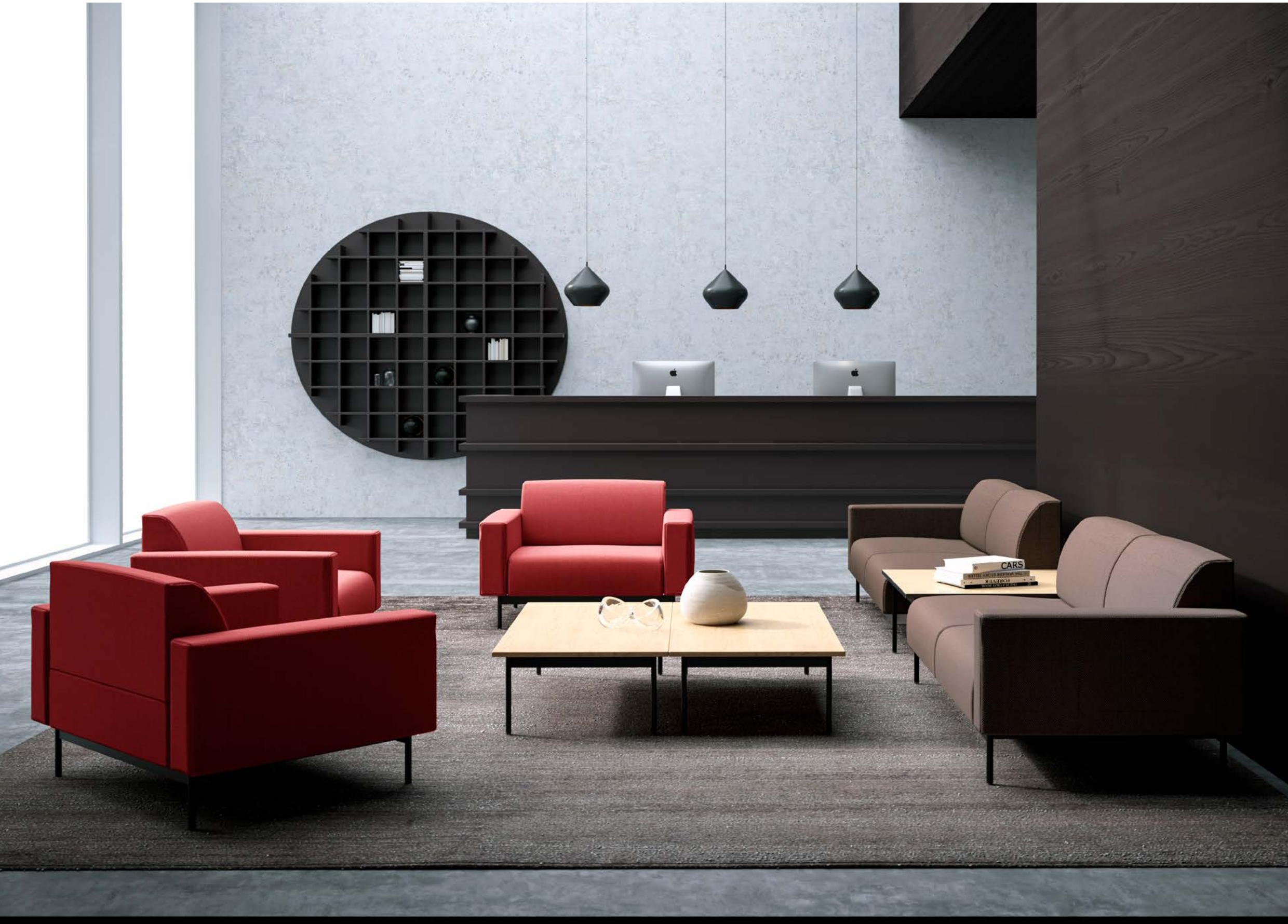





LONGWAY

Bartoli Design

Alla base di Longway l'idea di un nastro sinuoso e solido che disegna un'intera collezione di imbottiti, composta da pezzi molto vari ma contrassegnati da uno stile unico. Forme sottili e comode, da disporre in illimitate combinazioni, consentono di rispondere a molteplici esigenze di layout. Il sistema prevede, infatti, imbottiti singoli e componibili: panche, divani e tavolini a formare isole o composizioni lineari, angolari e curve. Perfetto per zone di sosta o di transito, spazi espositivi e luoghi semi-pubblici come elemento di attesa, relax e riunioni informali.

Longway is a sinuous and sturdy ribbon that designs an entire collection of modular upholstered seating, made of very different pieces of a unique style. Slender and comfortable shapes allow limitless compositions for multiple layout needs. The collection includes single and modular elements: benches, sofas and tables that form islands of linear, angular and curving configurations. Ideal for contract environments such as lobbies, waiting rooms, exhibition spaces, universities, shopping centers, airports, and large open spaces in many locales.

Longway est une collection d'assises rembourrées composée de modules aux formes très variées et au design original permettant de créer un "ruban sinueux et solide". Son design minimaliste et ses assises confortables permettent de proposer des combinaisons à l'infini. Le système prévoit des modules rembourrés indépendants ou reliés entre eux: banquettes, canapés et tables basses. Tout cela dans le but de former des îlots ou bien des compositions linéaires, angulaires ou courbes. Longway est parfaitement adapté aux environnements contracts: halls, salles d'attente ou lieu de fort passage. Dans des espaces d'exposition et des lieux semi publics, il répond à des besoins de détente, de relaxation et peut même s'adapter à des réunions informelles.

Die Form eines Bandes zeichnet eine ganze Kollektion von Polsterelementen aus, einzigartig und vielfältig. Schmale und bequeme Formen, die eine endlose Gestaltungsmöglichkeit für unterschiedliche Bereiche bieten. Die Kollektion besteht aus Einzel oder Modulelementen, Bänken, Sofas und Beistelltischen, um Inseln, gerade Formen, Ecken und Kurven zu konfigurieren. Ideal für den Objektbereich, Wartebereiche aller Art, Ausstellungsräume, Universitäten, Shopping Center, Flughäfen, grosse Räumlichkeiten.

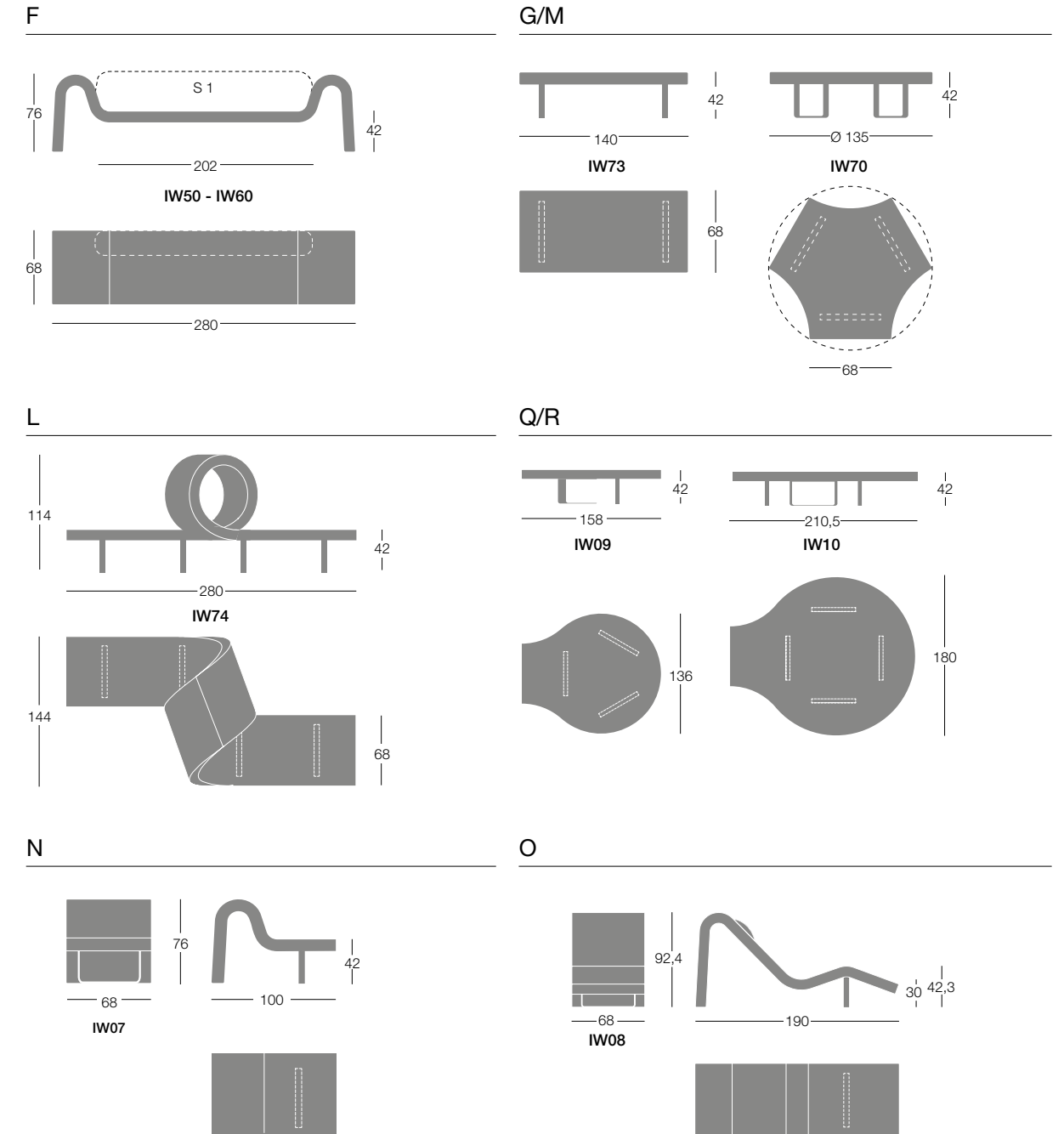
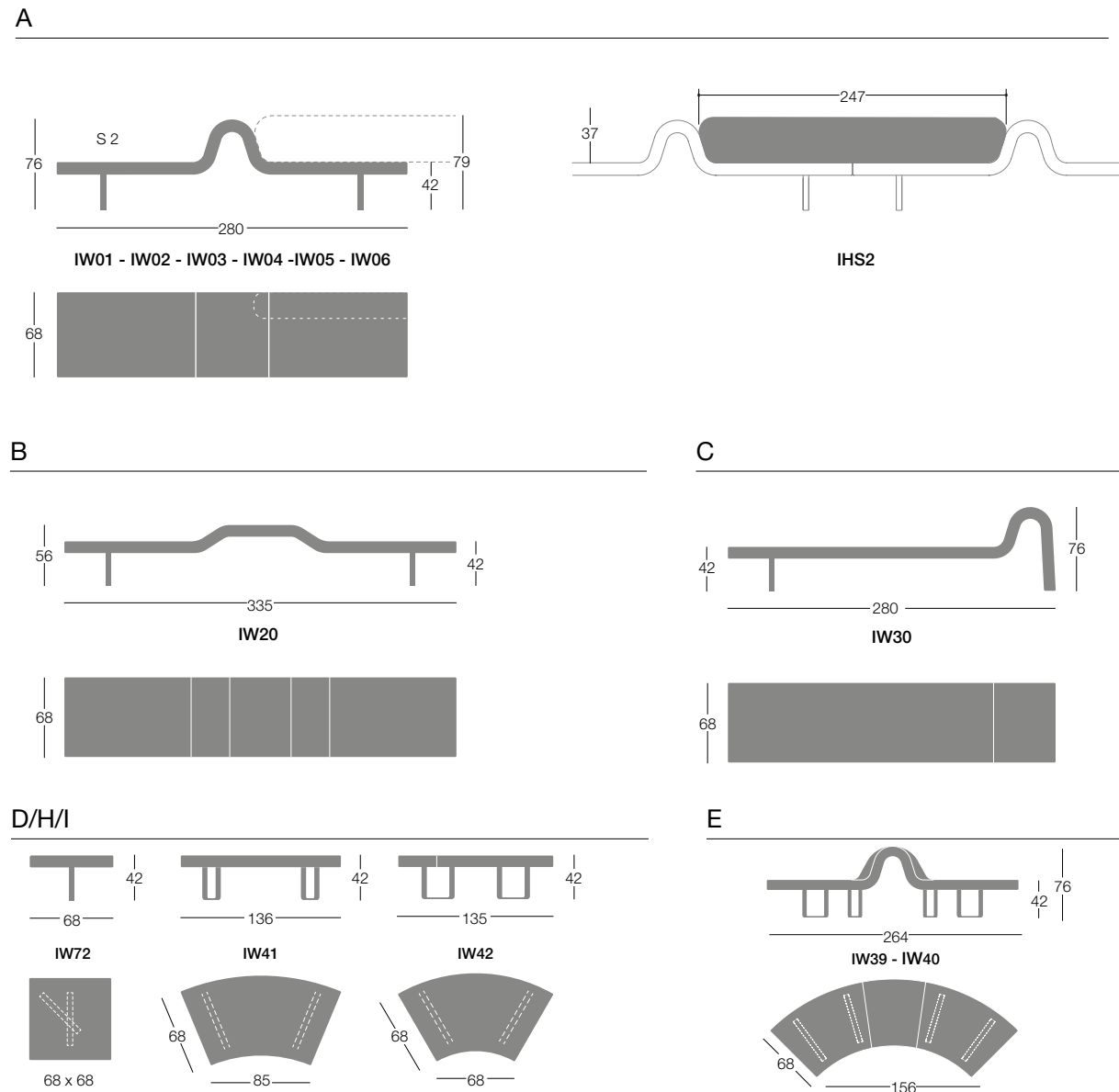

Finiture / Finishes / Finitions / Ausführungen

Struttura / Frame / Structure / Gestell

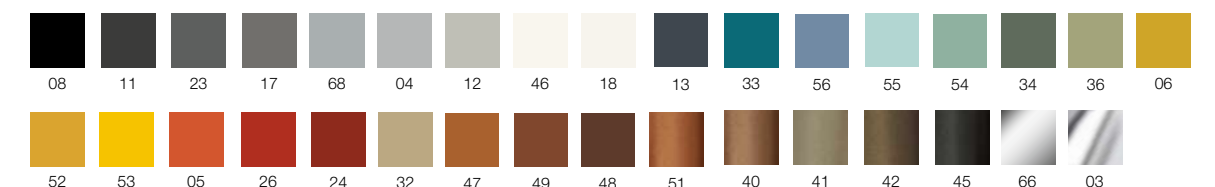

LONGWAY

Moduli / Modules / Modules / Module

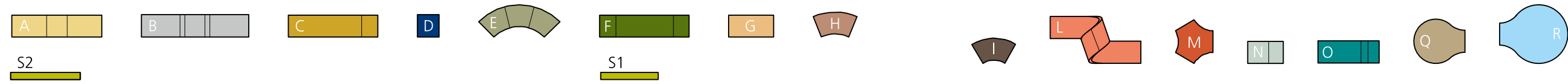

Esempi di composizioni / Composition examples / Exemples de compositions / Beispiele

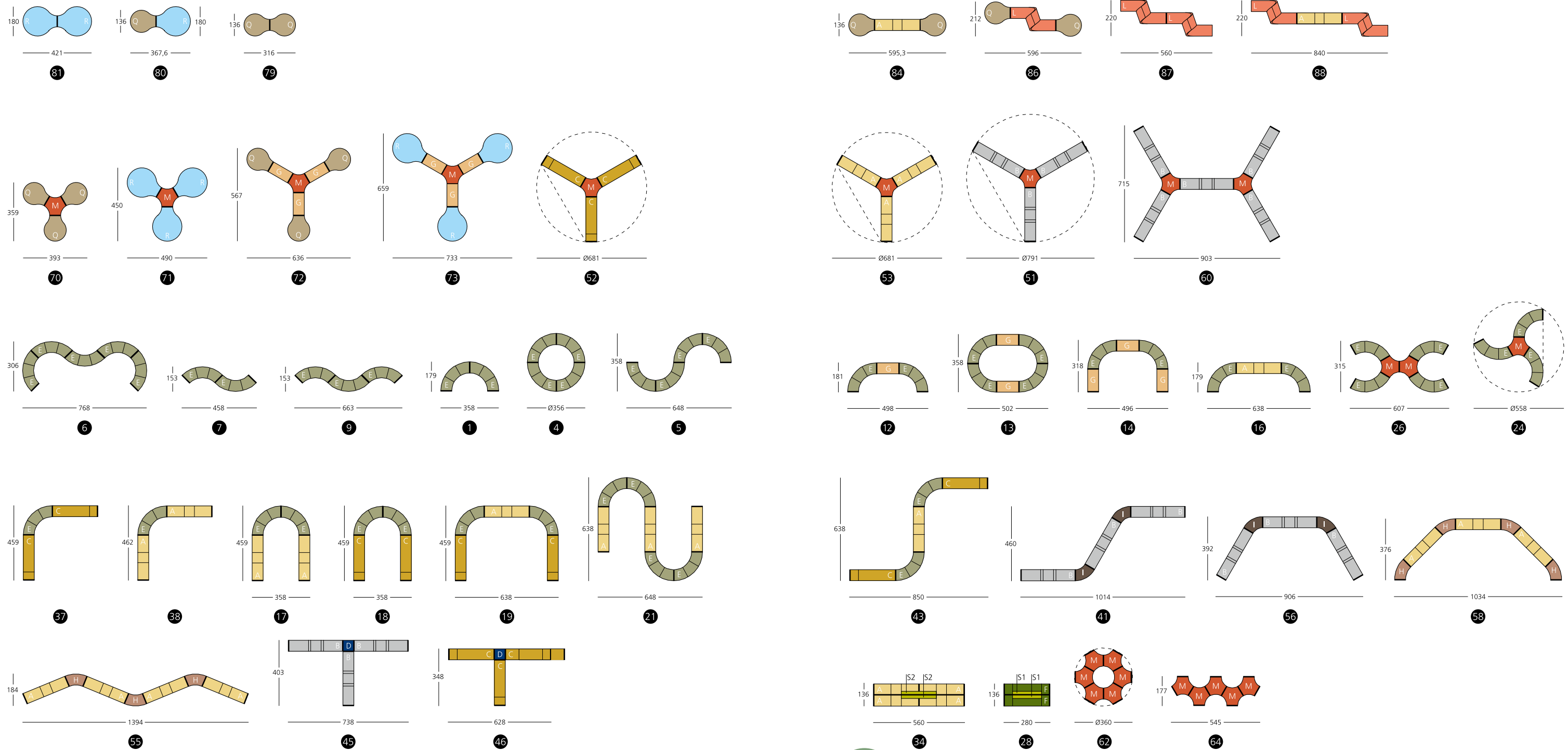

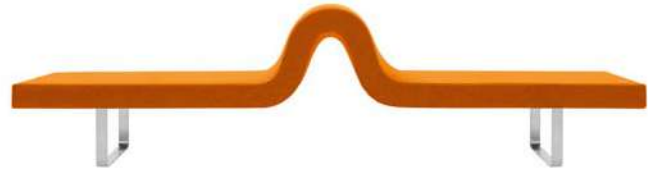

Longway A



Longway B

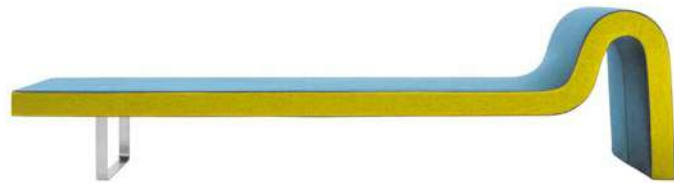

Longway C



Longway D / H / I

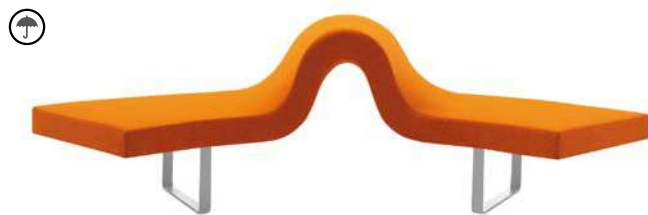

Longway E



Longway F



Longway G / M



Longway L



Longway N



Longway O



Longway Q



Longway R





Kunitachi College of Music, Tokyo, Japan



Wolfson Medical Centre, Holon, Tel Aviv, Israel



CGI Finance – Compagnie Générale de Location d'Equipements, Marcq-en-Baroeul, France



Library Frank Bartlett Memorial, Moe, Australia





Nemours Children's Hospital, Orlando, FL, USA





Ormond College Academic Centre, Melbourne, Australia



NOLDOR

Archirivolto Design

Noldor è un sistema di poltrone e divani imbottiti caratterizzato da una seduta ampia e da uno schienale con una particolare forma squadrata, in grado di offrire, in entrambe le altezze disponibili, protezione acustica e visiva. Un prodotto sempre attuale ed una soluzione interessante, adatta anche ad un uso eclettico e non esclusivamente operativo.

Noldor upholstered seating is characterized by a wide seat with a back in two dimensions. Its interesting squared shape offers true visual and acoustic protection. An updated and exciting solution to today's collaborative environment.

Noldor est un système d'assise rembourré. Original avec son siège large et son dossier de forme carrée, il offre une protection acoustique et visuelle dans les deux hauteurs disponibles. Un produit toujours actuel et une solution intéressante même pour une utilisation semiprofessionnelle.

Noldor ist ein Polstermöbelprogramm mit grosszügigem Sitzpolster und einer Rückenlehne in zwei Höhen. Diese bietet eine akustische und Sichtschutzfunktion. Ausgesuchte Ausführungen machen aus diesem Produkt eine interessante Lösung auch für Arbeitsbereiche.

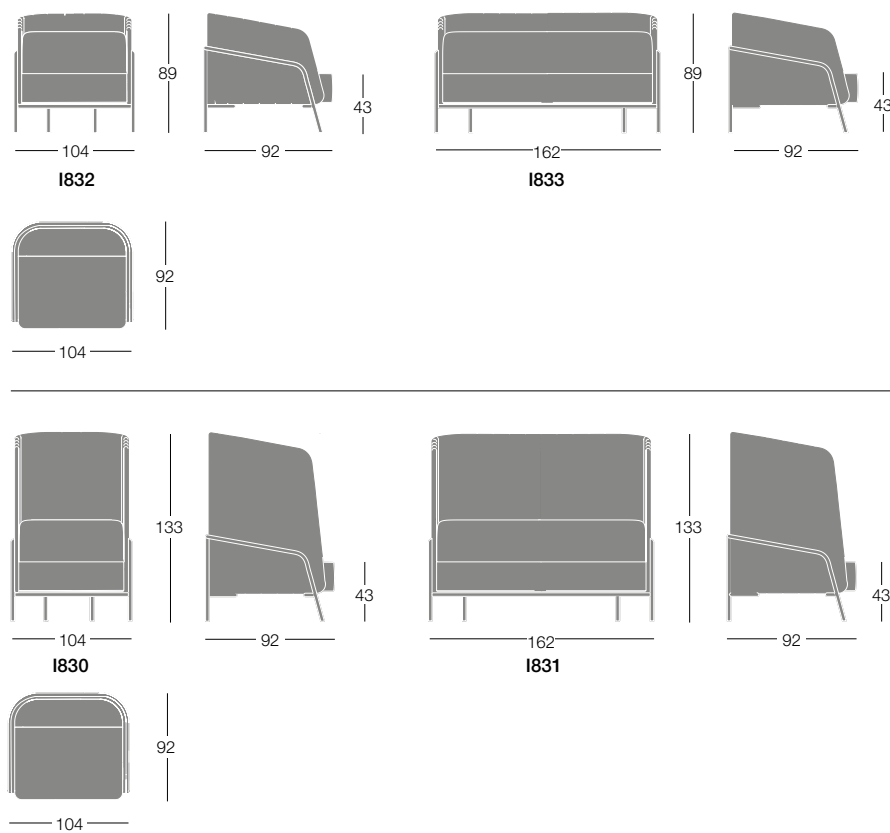

Finiture / Finishes / Finitions / Ausführungen

Struttura / Frame / Structure / Gestell

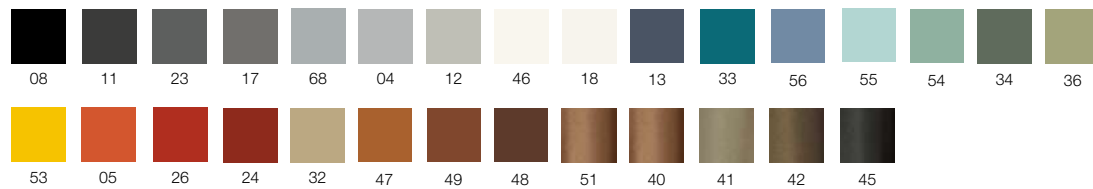

Struttura cromata / Chromed frame / Structure chromée / Gestell Verchromt







Marina Bay Financial Centre Headoffice, Singapore



West Gippsland Art Centre, Victoria, Australia





ABC Grand Cinema, Beirut, Lebanon





2 Degrees – Building Foyer Spaces, Auckland, New Zealand

OSCAR

Alejandro Valdés

Poltrona e divano 2/3 posti.
Con un gesto preciso e delicato, Oscar è una collezione soft seating pensata per spazi pubblici e residenziali che si caratterizza per un design raffinato ed un elevato comfort. Il suo dettagliato lavoro di tappezzeria avvolge un interno morbido ed accogliente, mentre l'esterno ha una seducente personalità. Composta da poltrona e divani, la collezione è disponibile in una vasta gamma di rivestimenti, che insieme alle diverse finiture delle gambe in legno massello o in metallo, è ideale per arredare aree d'attesa e aree di riposo di ufficio, ristoranti, hotel, musei e centri educativi.

Armchair and sofa 2/3 seats.
With a precise and delicate gesture, Oscar is a soft seating collection designed for public and residential spaces that is characterized by a refined design and high comfort. Its detailed upholstery work envelops a soft and welcoming interior, while the exterior has a seductive personality. Composed of an armchair and sofas, the collection is available in a wide range of coverings, which together with the different finishes of the solid wood or metal legs, is ideal for furnishing waiting areas and rest areas of offices, restaurants, hotels, museums and educational centers. Oscar responds to the needs of representative spaces, creating a pleasant atmosphere that facilitates relaxation, meeting and collaboration.

Fauteuil et canapé 2/3 places.
Avec un geste précis et délicat, Oscar est une collection de sièges moelleux conçue pour les espaces publics et résidentiels qui se caractérise par un design raffiné et un confort élevé. Son revêtement minutieux enveloppe un intérieur doux et accueillant, tandis que l'extérieur a une personnalité séduisante. Composée de fauteuil et canapés, la collection est disponible dans une large gamme de revêtements qui, avec les différentes finitions des pieds en bois massif ou en métal, est idéale pour meubler les zones d'attente et de repos des bureaux, restaurants, hôtels, musées et centres éducatifs. Oscar répond aux besoins des espaces représentatifs, créant une atmosphère agréable qui facilite la détente, la rencontre et la collaboration.

Sessel und Sofa, 2-Sitzer / 3-Sitzer.
Oscar, mit seiner präzisen und zarten Gestik, ist eine gepolsterte Sitzkollektion, die für öffentliche und private Räume geschaffen wurde und sich durch ein raffiniertes Design und hohen Komfort auszeichnet. Die Polsterungen umhüllen ein weiches und einladendes Inneres, während das Äußere eine verführerische Persönlichkeit hat. Die aus einem Sessel und Sofas bestehende Kollektion verfügt über eine große Auswahl an Bezügen. Kombiniert mit den verschiedenen Ausführungen der Beine aus Massivholz oder Metall eignet sie sich ideal für die Einrichtung von Warte- und Ruhebereichen in Büros, Restaurants, Hotels, Museen und Bildungszentren.

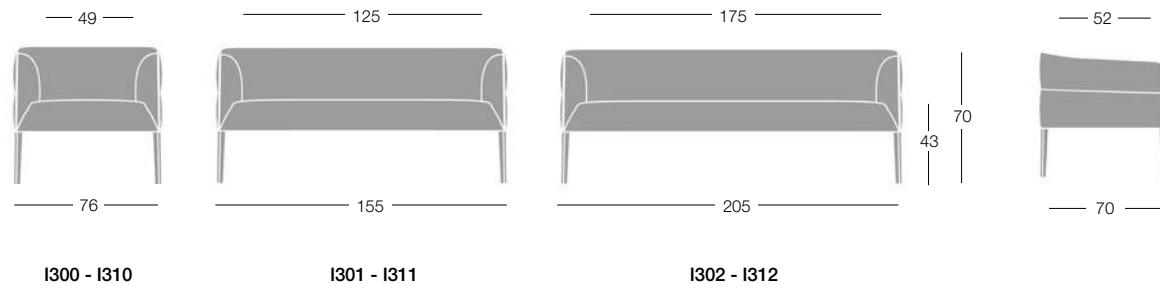

I300 - I310

I301 - I311

I302 - I312

Finiture / Finishes / Finitions / Ausführungen

Struttura / Frame / Structure / Gestell

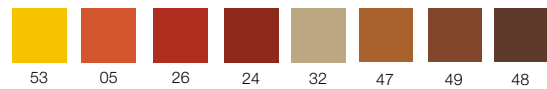
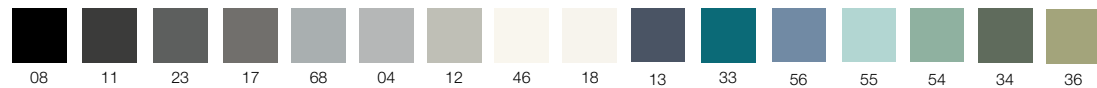

Legno / Wood / Bois / Holz (art. I310-I311-I312)



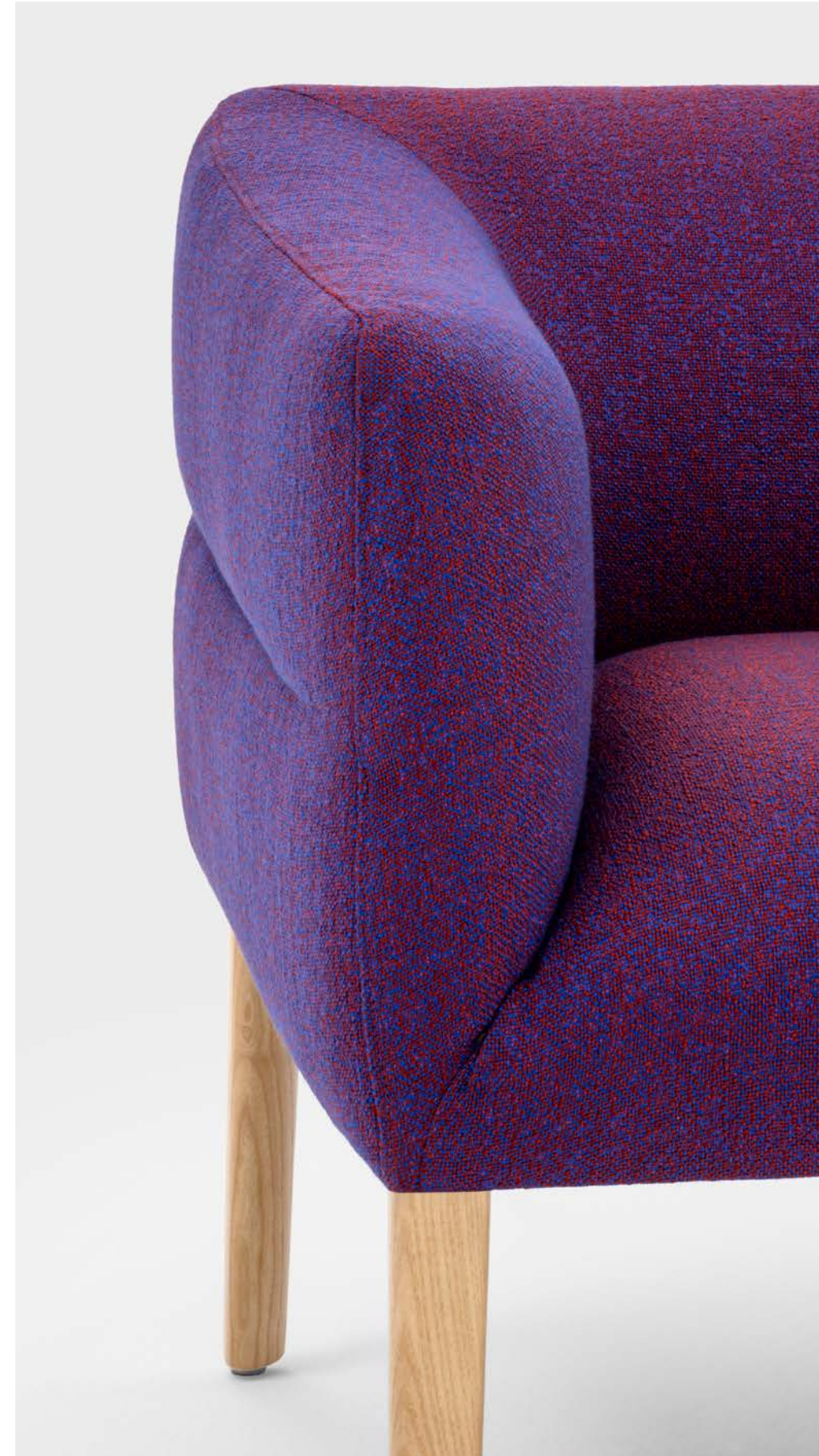



REY

Archirivolto Design

Rey é un sistema di divani creato sull'idea di un pontile sul quale si adagiano morbide sedute, con un perimetro in legno che definisce la linea e ne esalta le finiture. L'imbottito é generoso, soffice, anche grazie alla profondit  di sedute. Si compone in forme chiuse di alti braccioli o aperte su un lato con un ampio tavolino in legno.

Rey is a sofa system created on the idea of a pier on which soft seats lie, with a wooden perimeter that defines the line and enhances its finishes. The upholstery is generous, soft, also thanks to the depth of the seat. With its high armrests, Rey surrounds the user, but it can also be open on one side with a large wooden coffee table.

Rey est un syst me de canap s cr e sur l'id e d'une jet e sur laquelle des si ges moelleux sont inclin s, avec un p rim tre en bois qui d finit la ligne et valorise les finitions. Le rembourrage est g n reux et doux,  galement gr ce   la profondeur de l'assise. Il est compos  de formes ferm es par de hauts accoudoirs ou ouvertes sur un c t  avec une grande table en bois.

Rey ist ein Sofasystem, das auf der Idee eines Stegs basiert, auf dem weiche Sitze ruhen, mit einer Holzumrandung, die die Linie definiert und die Oberfl chen hervorhebt. Die Polsterung ist nobel, weich, auch dank der Sitztiefe. Sie setzt sich aus geschlossenen Formen mit hohen Armlehnen oder einseitig offen mit einem gro en Holzbeistelltisch zusammen.

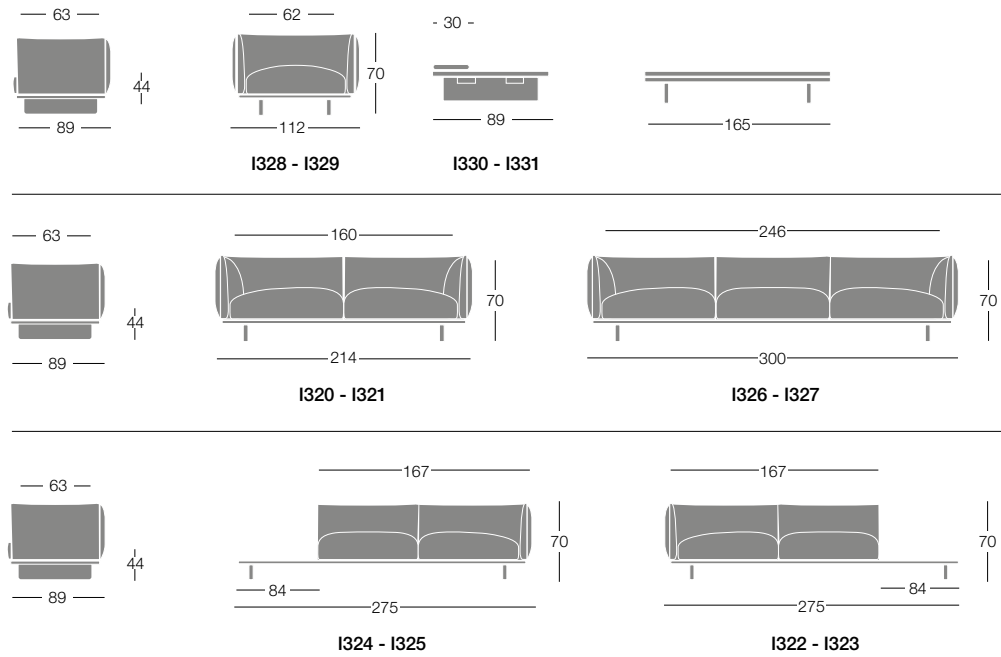

Finiture / Finishes / Finitions / Ausf hrungen

Struttura / Frame / Structure / Gestell

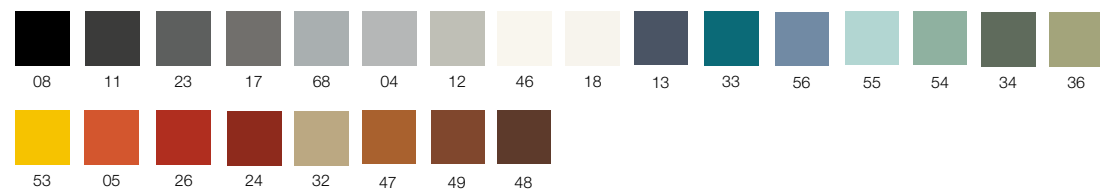

Legno / Wood / Bois / Holz

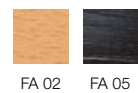





SKYLAN

Altherr Désile Park

Skylan rappresenta un nuovo tipo di design nel "soft seating". Concepito come un sistema di panche semplice ma versatile, Skylan crea atmosfere aperte e invitanti negli spazi contract. Imbottiture visibilmente morbide e schienali generosamente proporzionati possono essere configurati per suggerire spazi individuali o luoghi in cui sedersi insieme. Le singole unità creano bellissime isole private in spazi di transizione, mentre i moduli più grandi possono essere collegati per aree di attesa o atri spaziosi.

Skylan represents a new kind of architecture in soft seating. Conceived as a simple yet versatile soft bench system, Skylan creates open and inviting atmospheres in contract spaces. Visibly soft upholstery and generously proportioned backrests can be configured to suggest individual spaces or places to sit together. Individual units make wonderful private islands in transitional spaces, whereas larger modules can be connected for waiting areas or spacious atriums.

Skylan représente un nouveau type de design dans les "soft seating". Conçu comme un système de banquettes simple mais polyvalent, Skylan crée des atmosphères ouvertes et invitantes dans les espaces contractuels. Un rembourrage visiblement doux et des dossiers aux proportions généreuses peuvent être configurés pour suggérer des espaces individuels ou des endroits où s'asseoir ensemble. Les modules individuels créent de beaux îlots privés dans des espaces de transition, tandis que des modules plus grands peuvent être connectés pour des zones d'attente ou des halls spacieux.

Skylan steht für eine neue Art von Design im Bereich „weicher Sitzgelegenheiten“. Als einfaches, aber vielseitiges Banksystem konzipiert, schafft Skylan offene und einladende Atmosphären in Contract-Bereichen. Sichtbar weiche Polster und großzügig dimensionierte Rückenlehnen lassen sich so konfigurieren, dass sie individuelle Umgebungen oder Orte zum Zusammensitzen schaffen. Einzelne Einheiten schaffen schöne private Inseln in Übergangsbereichen, während größere Module für geräumige Wartebereiche oder Lobbys verbunden werden können.

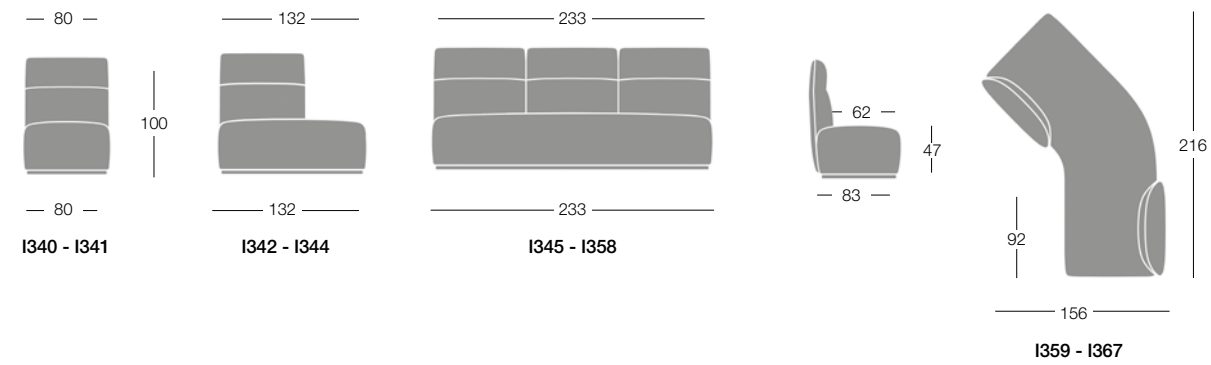

Finiture / Finishes / Finitions / Ausführungen

Struttura / Frame / Structure / Gestell

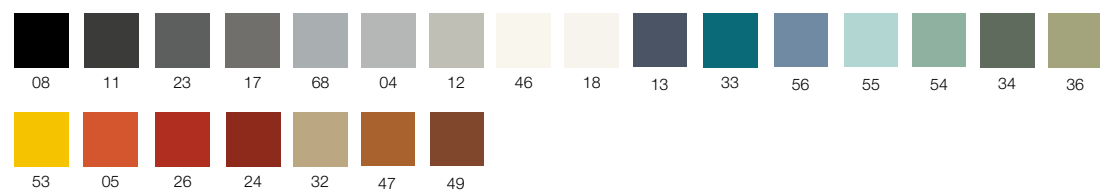

Moduli / Modules / Modules / Module

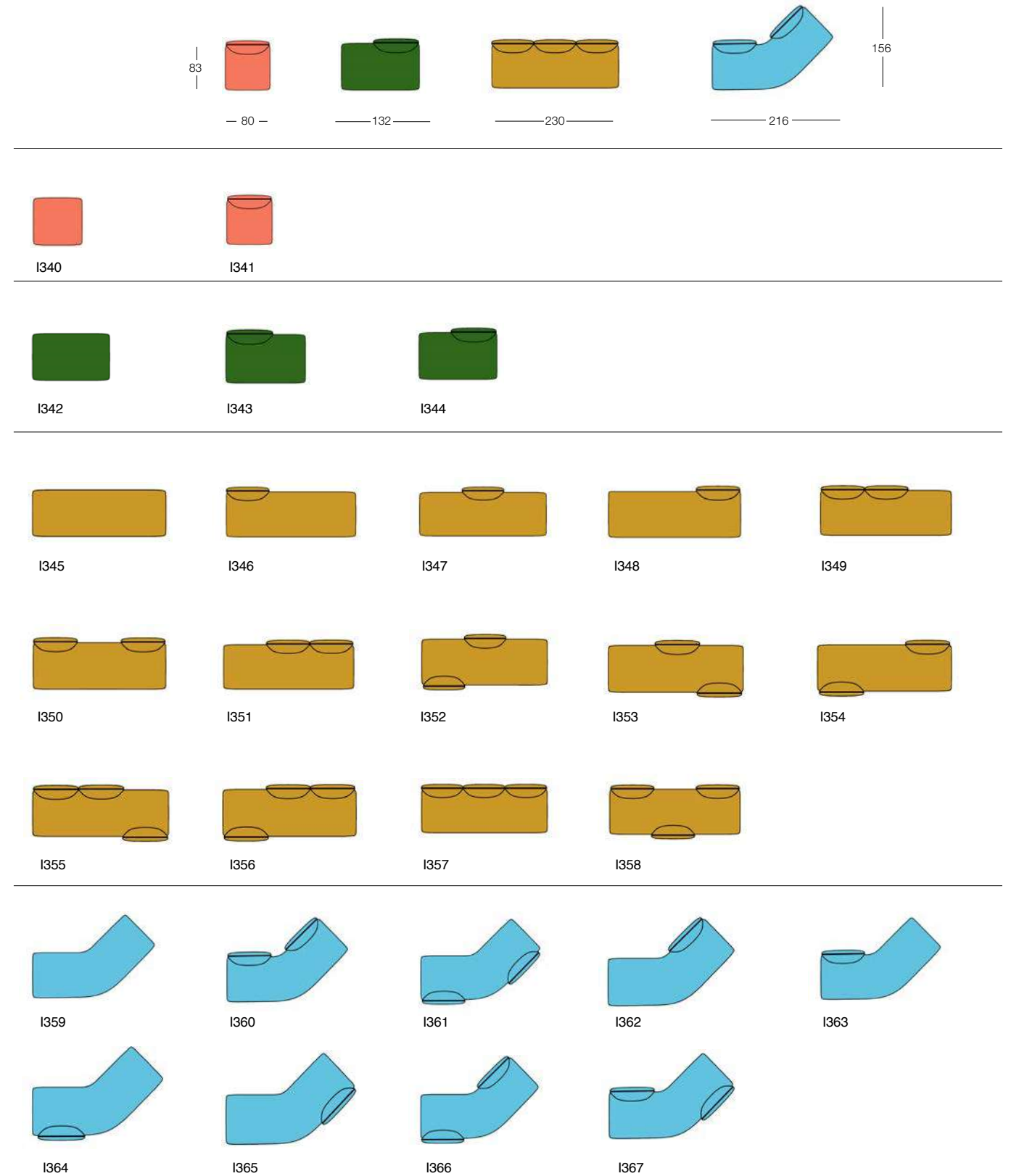

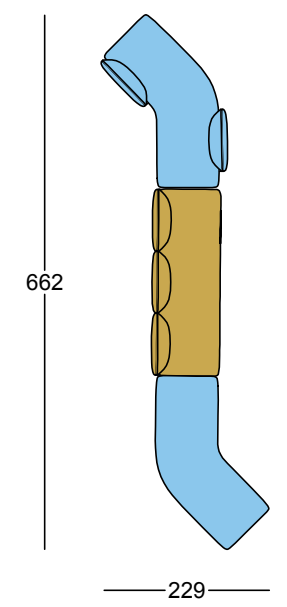
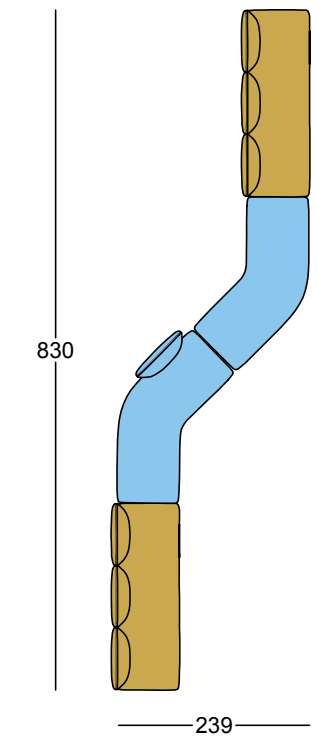
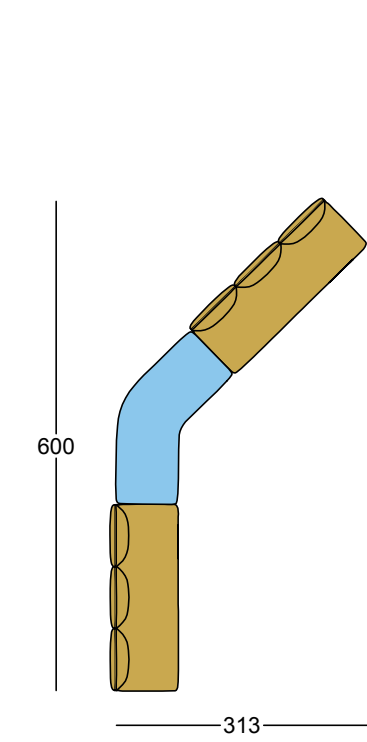
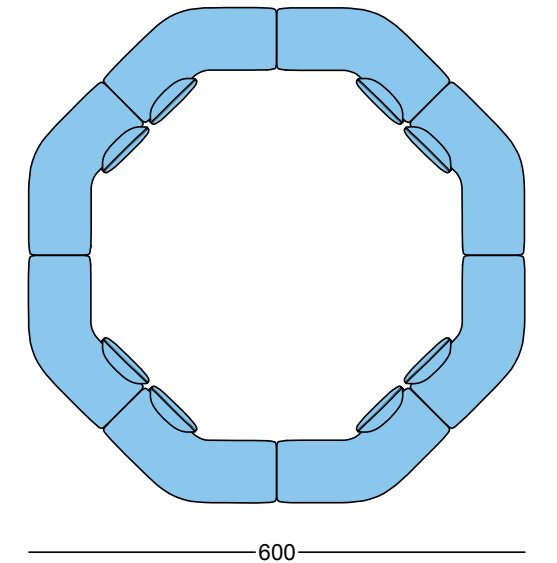
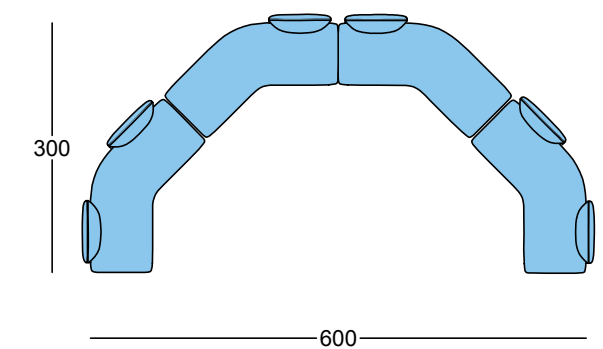
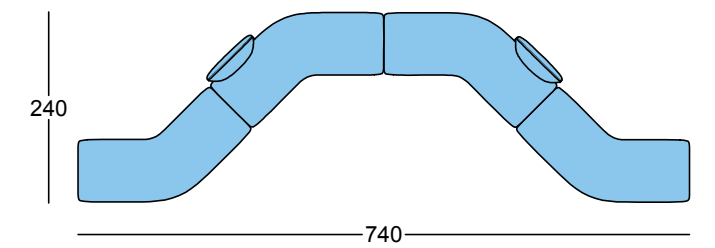
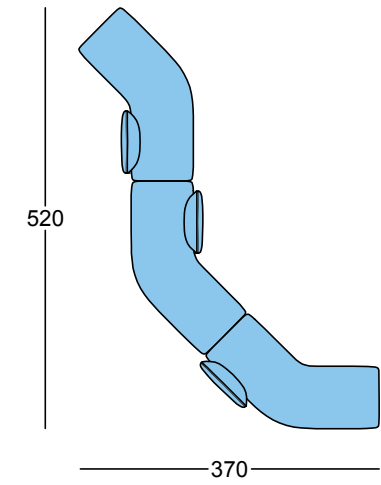
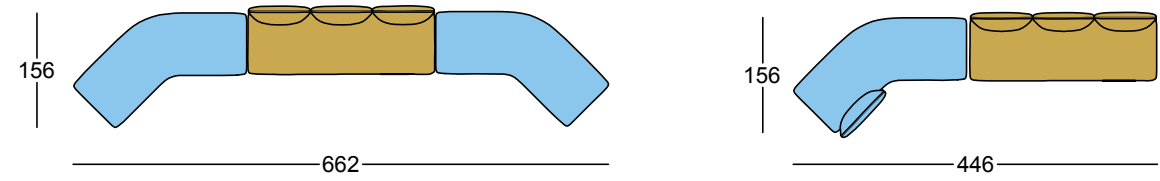
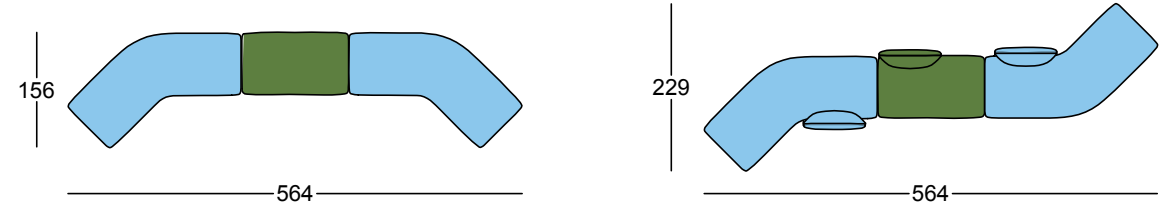
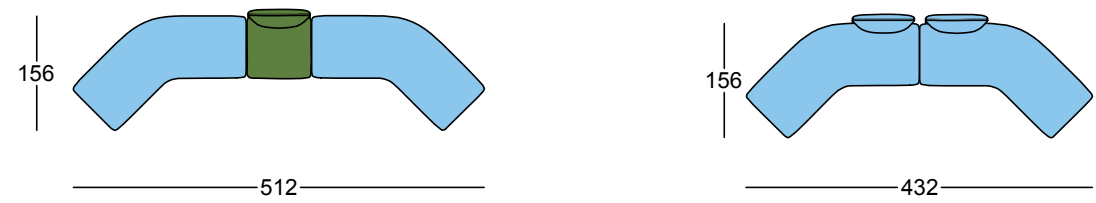
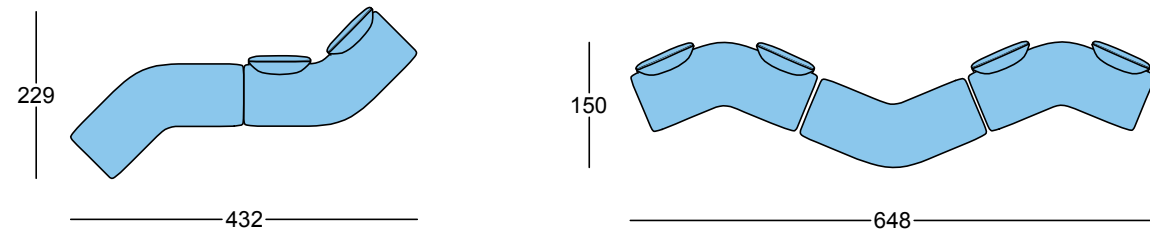
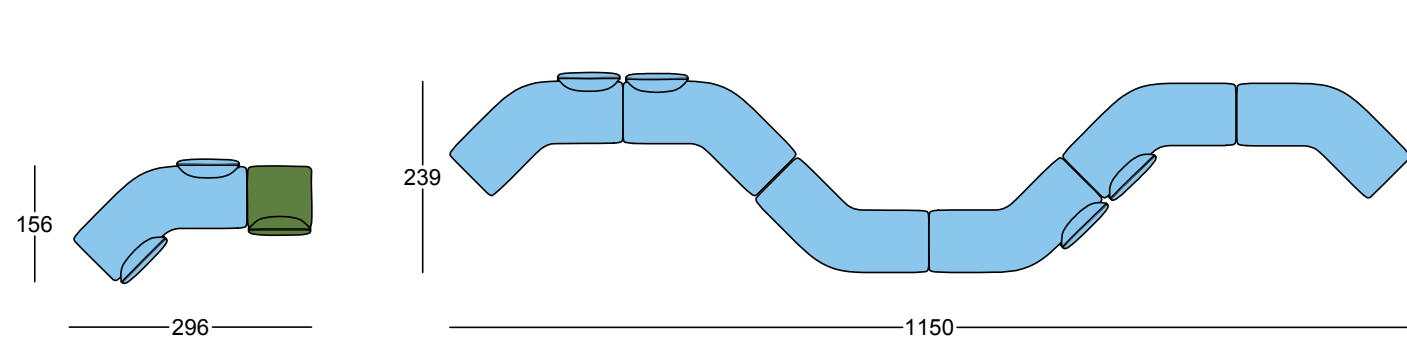







STEAK&STILTON

Carlo Bimbi

Steak & Stilton, è un sistema di sedute che si ispira all'atmosfera dei caffè parigini e delle più moderne tavole calde, sintetizzando un'interessante mix di influenze internazionali senza tempo. Versatile, con le sue forme ad angolo o lineari, consente di organizzare lo spazio creando situazioni diverse, dalle più raccolte a quelle più aperte. Se rivestito capitonné può risaltare anche negli ambienti più chic ed eleganti.

Inspired by the atmosphere of Parisian cafes, Steak & Stilton has a timeless international flair. Its angular and linear shapes allow versatile vis à vis or open arrangements which may be enhanced by chic button tufting.

Steak & Stilton, est un système d'assises qui rappelle l'atmosphère des vieux cafés parisiens et aussi de cafés restaurants plus modernes et informels. Son design est un mix intemporel d'influences internationales très diverses. Son côté polyvalent, avec des éléments à la fois linéaires et en angle, permet de combiner ses solutions d'assises à l'infini pour tout type de besoin - isolé, ouvert ou de simples linéaires. Sa finition capitonnée permet aussi de s'adapter aux lieux les plus chics.

Inspired by the Atmosphäre der Pariser Cafes, Steak & Stilton ist von zeitlosem Flair. Vielfältig mit geraden oder Eckmodulen erlaubt er den Raum für unterschiedlichen Einsatz zu gestalten. In der gesteppten Ausführung passt er zu elegantem Ambiente.

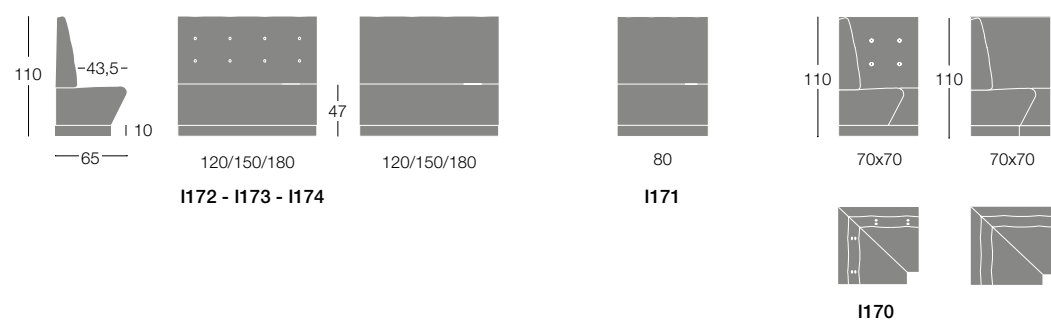

Esempi di composizioni / Composition examples / Exemples de compositions / Beispiele

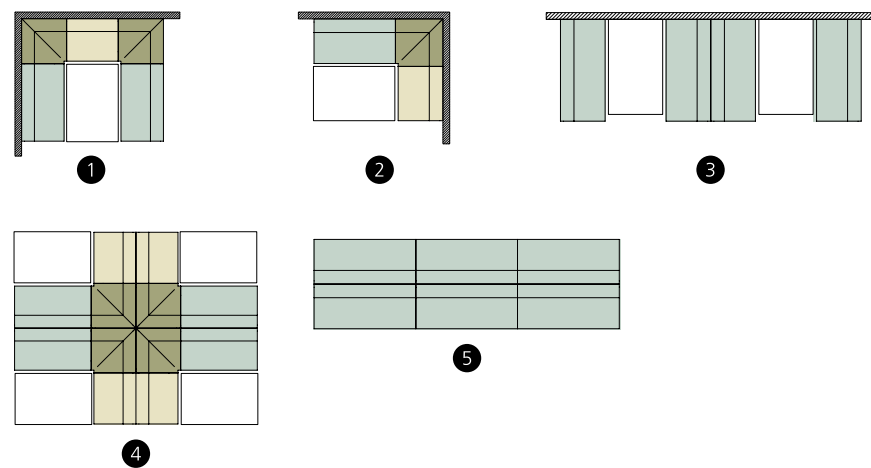

Finiture / Finishes / Finitions / Ausführungen

Struttura / Frame / Structure / Gestell

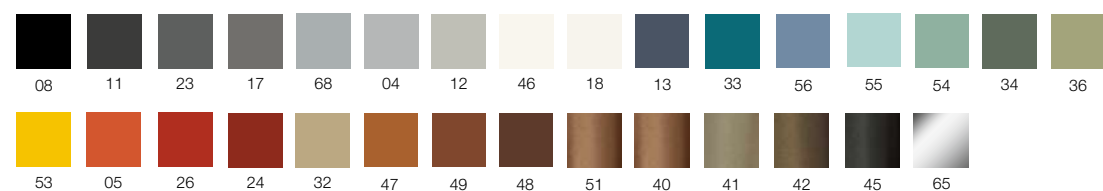

imbottiti / lounge seating / rembourrés / Polstermöbel







Perfecto Mobile, Tel Aviv, Israel

TERMINUS

Carlo Bimbi

Divanetto pensato appositamente per il ristorante e i momenti di incontro. Realizzato in forma imbottita, è un modulo che, unito ad altri, compone angoli e linee in grado di delineare diverse sale da pranzo. A completare il sistema, i pannelli divisorii, che consentono di creare situazioni più articolate e intime.

Terminus, an upholstered sofa designed to accommodate the pleasure of eating. Modules can be combined to create numerous angular or linear dining rooms; optional upholstered or laminate high back partition panels create secluded areas.

Terminus est un système de petits canapés conçus pour pouvoir se restaurer sur une assise rembourrée. Ses modules très variés permettent de créer des angles et ainsi avoir différents espaces de salle à manger. Enfin il existe aussi des panneaux de séparation permettant de diversifier les possibilités d'aménagement et de créer de l'intimité.

Ein Polstersofa für Essbereiche entworfen. Ein Modulare System mit Eck- und Geradeelementen, mit vielfältiger Gestaltungsmöglichkeit. Ergänzend zu dem System sind Trennpaneele, um Diskretionsbereiche zu schaffen.

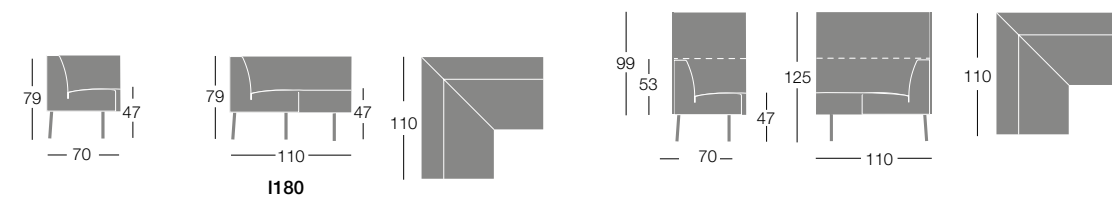
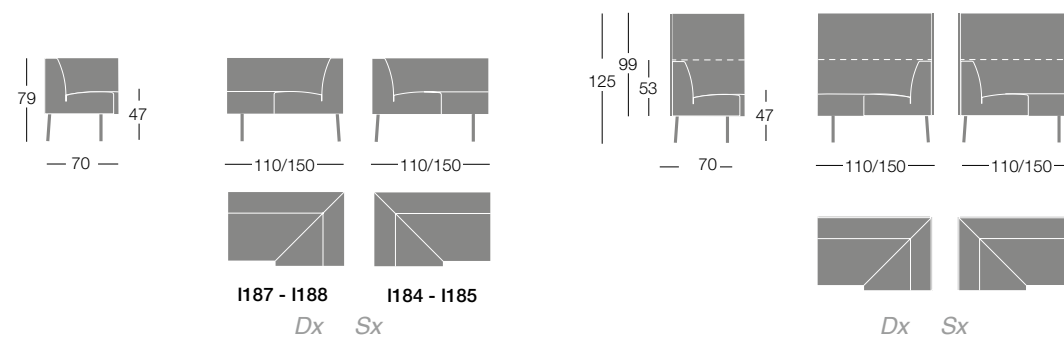
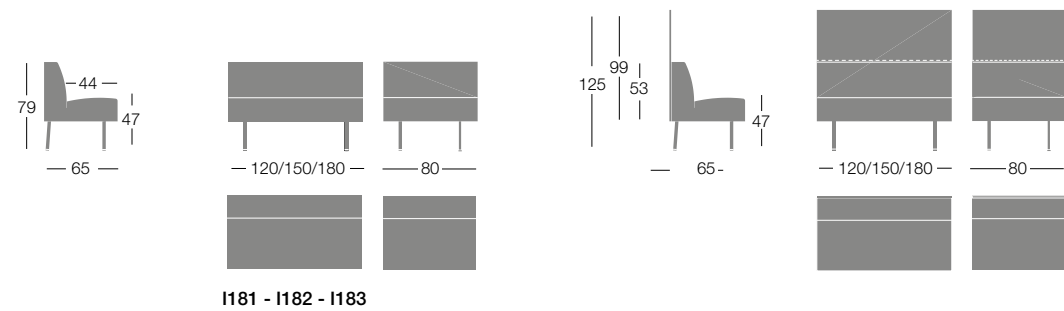

Esempi di composizioni / Composition examples / Exemples de compositions / Beispiele

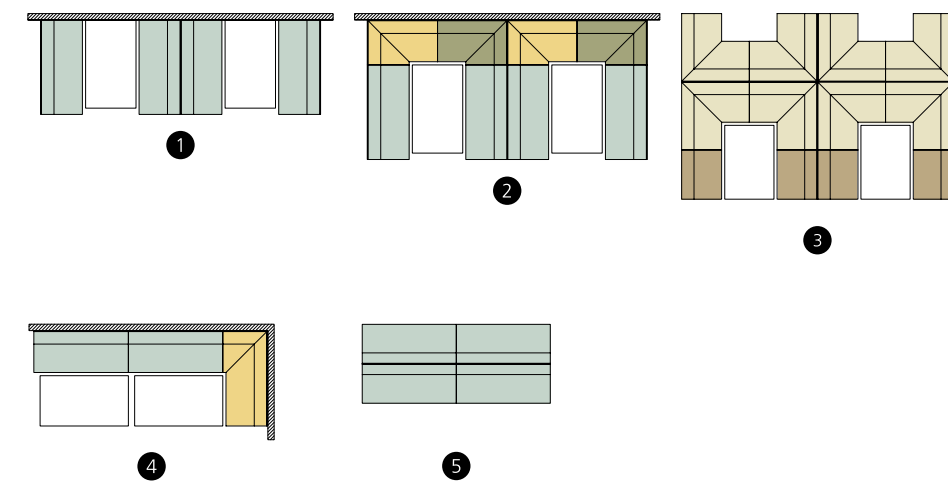

Finiture / Finishes / Finitions / Ausführungen

Struttura / Frame / Structure / Gestell

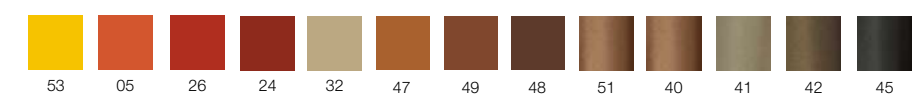
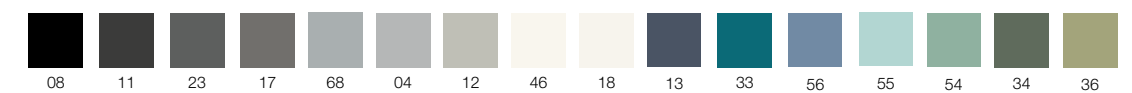

Struttura cromata / Chromed frame / Structure chromée / Gestell Verchromt







ACCESSORI
ACCESSORIES
COMPLÉMENTS
ZUBEHÖRSERIE

ELLIPSE

Bartoli Design

Frutto della creatività dello studio Bartoli, la serie Ellipse include alcuni complementi disegnati sia per gli ambiti professionali sia per gli spazi residenziali. Alla gamma di appendiabiti, che presenta una versione "a terra" e una versione da parete applicabile, si aggiunge un carrello appendiabiti su ruote disponibile in più varianti ed un gettacarte.

From the creativity of Bartoli Design, Ellipse includes accessories designed for both professional and residential spaces. To the range of floor and wall coat hangers, a clothes hanger trolley on wheels is also added, available in 3 variants, and a waste paper basket.

Création du studio Bartoli, la collection Ellipse est une série d'accessoires conçus pour les espaces professionnels et résidentiels. Dans la gamme des portemanteaux, en version sur pieds et patère murale, nous proposons également un chariot porte-manteaux sur roulettes, en plusieurs versions et une corbeille à papier.

Von der Kreativität von Bartoli Design besteht die Serie Ellipse aus Accessoires für den Objekt- und privaten Wohnbereich. Kleiderständer mit rundem Fußsteller und für Wandbefestigung. Ergänzend dazu ein Garderobeständer auf Rollen in verschiedenen Versionen und ein Papierkorb.

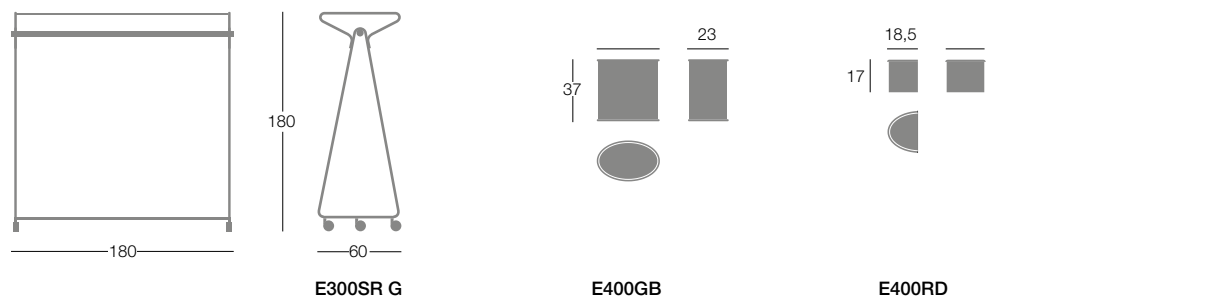
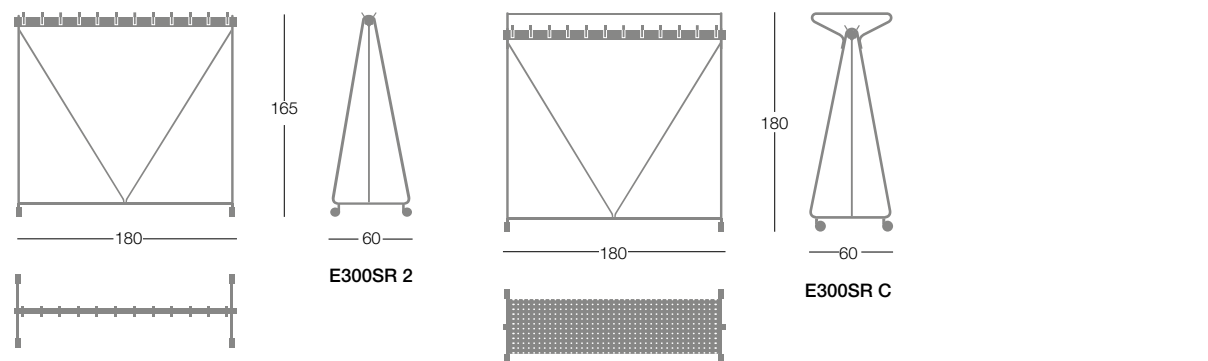
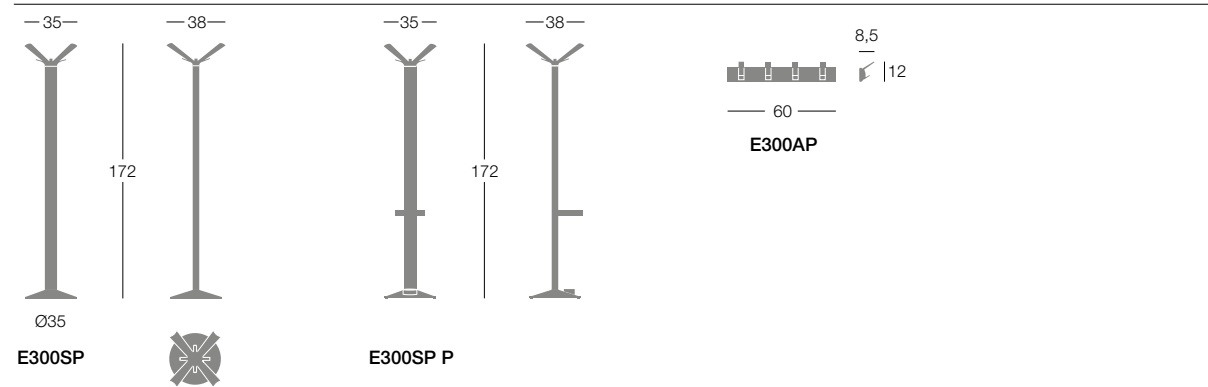

Finiture / Finishes / Finitions / Ausführungen

Struttura / Frame / Structure / Gestell

