

Workstations

dvo_



Lifeful place for lifeful people

Dal lavoro ibrido alla realtà in continua evoluzione: anche DVO si rinnova, rivelando una doppia anima. Un progetto nel progetto. Dal design dei servizi alla gestione completa di una commessa o di un intero progetto speciale.

Siamo una service company che risponde ad ogni idea creativa con prodotti sostenibili, un servizio just in time e una logistica affidabile, ma siamo anche partner di progetto, innovativo e versatile per professionisti e mondo corporate, fornendo un supporto completo in ogni fase del processo. Mettiamo al centro il benessere delle persone, perché questa è la vera evoluzione dello spazio lavoro.

La nostra impronta green, per il pianeta e per le future generazioni, passa anche attraverso l'utilizzo di materie prime rinnovabili, investimento continuo in certificazioni aziendali e di prodotto, controllo della qualità delle materie prime e dell'aria. Oggi siamo una duplice identità pronta a riscrivere le regole con un nuovo modello di business.

From hybrid work to constantly evolving reality: DVO renews itself, revealing a dual soul. A project within a project. From service design to the complete management of the global order or special project.

We are a service company that responds to every creative idea with sustainable products, a just-in-time service and reliable logistics, but we are also an innovative and versatile project partner for professionals and companies, providing comprehensive support at every stage of the process. We put people's well-being at the centre, because this is the true evolution of the workspace.

Our green thinking, for the planet and for future generations, goes also through the use of renewable raw materials, continuous investment in company and product certifications, quality control of raw materials and air. Today we are a twofold identity ready to rewrite the rules with a new model of business.

Fluid design

Equilibrio | Essenza umana | Inclusività | Natura | Fluidità |
Movimento | Design flessibile | Diversità | Benessere assoluto |
Smart living | Talento interiore | Evoluzione

Lavoro agile, libertà di integrare vita e lavoro, equilibrio e talento interiore. Il nuovo ufficio abbraccia l'essenza umana, diventando uno spazio privo di confini, disegnato per il benessere assoluto. Il design flessibile spinge verso ambienti rilassanti, stimolando la creatività e riducendo lo stress.

L'innovazione digitale amplifica questo viaggio, consentendo la scelta del luogo e dell'orario di lavoro. La diversità diventa inclusività, una contaminazione culturale e un nomadismo positivo che arricchiscono le possibilità, disegnando strade verso nuove prospettive, luoghi e volti.

L'evoluzione dell'ufficio crea spazi ibridi in continuo movimento, plasmati per soddisfare le esigenze mutevoli e per incentivare il dialogo con gli altri. L'armonia e la rigenerazione emergono dal bilanciamento di un'esistenza consapevole: uno stile di vita intelligente che grazie alla tecnologia crea un equilibrio responsabile, una connessione e una fluidità positiva tra lavoro e natura.

Balance | Human essence | Inclusivity | Nature | Fluidity |
Movement | Flexible design | Diversity | Absolute well-being |
Smart living | Inner talent | Evolution

Agile working, freedom to integrate life and work, balance and inner talent. The new workplace embraces the human essence, becoming a boundless space designed for absolute well-being. The flexible design pushes towards relaxing environments, stimulating creativity and reducing stress.

Digital innovation amplifies this journey, allowing the choice of place and working time. Diversity becomes inclusivity, cultural contamination and positive nomadism enriching possibilities, drawing roads to new perspectives, places and faces.

The evolution of the office creates hybrid spaces in constant movement, shaped to meet changing needs and to encourage dialogue. Harmony and regeneration emerge from the balance of conscious living: a smart living to create a responsible balance, connections and positive fluidity between work and nature.



Plants and Leaves Workstations

Green: una parola che, oltre a definire l'universo vegetale, rappresenta uno dei core concept di DVO. L'elemento naturale del verde, nelle sue infinite variazioni, scandisce il racconto del catalogo Workstations.

Green: a word which, as well as defining the world of plants, represents one of DVO's fundamental concepts. The natural element of green, in its infinite variations, punctuates the narrative of the Workstations catalogue.



Indice

Index

Workstations	E-PLACE DV804	p. 10
	ENTITY DV801	p. 28
	ENNA DV812	p. 46
	PAG DV802	p. 66
	NOBU DV803	p. 120
	TOLEDO DV818	p. 138
	TREKO DV805	p. 150
	OSLO DV817	p. 162
	NIDA DV816	p. 174
	SHELL SYSTEM DV650	p. 180
Multimedia	E-MEDIA DV401	p. 196
	MOBILE WALL DV420	p. 204
Specifiche tecniche Technical Sheets		p. 211



Design
PERIN&TOPAN

E-PLACE

DV804

Il futuro del lavoro abbraccia un approccio ibrido e intelligente che pone al centro l'individuo. I tavoli DV804-E-Place interpretano questa nuova tendenza e sono progettati sia per un uso temporaneo che continuativo. L'utilizzatore può accedere, in modo facile e veloce, alle opzioni per l'alimentazione e dati, mentre gli schermi assicurano una privacy acustica e visiva per tutte le attività che richiedono concentrazione. Il design moderno della struttura metallica a cavalletto si svincola dal concetto di gambe con posizione prestabilita: il sistema consente di riposizionarle a piacimento, anche dopo l'installazione. I tavoli sono realizzati con materiali durevoli e di qualità certificata, a vantaggio della sostenibilità. Accessori ed elementi aggiuntivi quali portalampade, screen o bracci per monitor si possono posizionare liberamente. Una specifica canalina verticale, calamitata alle gambe, consente di celare i cavi elettrici. I tavoli DV804-E-Place promuovono la collaborazione spontanea, trasformando l'ufficio in un luogo funzionale e dinamico.

The future of work embraces a hybrid and intelligent approach that places the person at the centre. The DV804-E-Place tables interpret this new trend and are designed for both temporary and continuous use. The user can access power and data options quickly and easily, while screens provide acoustic and visual privacy for all activities requiring concentration. The modern design of the metal trestle structure breaks away from the concept of legs with a predetermined position: the system allows them to be repositioned at will, even after installation. The tables are made of durable, quality-certified materials for the benefit of sustainability. Accessories and additional elements such as lamp holders, screens or monitor arms can be freely installed. A special vertical cable duct, magnetised to the legs, allows electrical cables to be hidden. The workstations DV804-E-Place promote spontaneous collaboration, transforming the office into a functional and dynamic place.



Bench L 400 P 166.5 cm comprensivo di piani terminali L 40 cm
Piano scrivania: melaminico bianco
Gambe: metallo verniciato bianco
Frontal panel acustico: tessuto JB9109 pepe
Bench W 400 D 166.5 cm including terminal tops W 40 cm
Worktop: white finish melamine
Legs: white painted metal
Acoustic Screen: fabric JB9109 pepper

Workstations
DV804 - E-PLACE



Scrivanie in linea e bench
Piano scrivania: melaminico terra d'ombra
Gambe: metallo verniciato bianco
Frontal panel acustico: tessuto JB9110 sesamo
In-line desks and bench
Worktop: Umber finish melamine
Legs: white painted metal
Acoustic screen: fabric JB9110 sesame

Workstations
DV804 - E-PLACE



Bench L 180 P 166.5 cm
Piano scrivania: melaminico grigio chiaro
Gambe: metallo verniciato antracite
Frontal panel: melaminico alluminio sp. 10 mm
Mobile di servizio: melaminico alluminio
Ante scorrevoli: melaminico nero opaco soft touch
Bench W 180 D 166.5 cm
Worktop: light grey finish melamine
Legs: anthracite painted metal
Screen: aluminium finish melamine th. 10 mm
Service cabinet: aluminium finish melamine
Sliding doors: matt black soft touch finish melamine



Workstations
DV804 - E-PLACE



Tavolo riunioni L 140 P 140 cm
Piano: melaminico noce
Gambe free standing: metallo verniciato bianco
Meeting table W 140 D 140 cm
Top: walnut finish melamine
Free standing legs: white painted metal

Scrivania L 180 P 80 cm
Piano scrivania e modesty panel: melaminico noce
Gambe: metallo verniciato bianco
Desk W 180 D 80 cm
Worktop and modesty panel: walnut finish melamine
Legs: white painted metal

Workstations
DV804 - E-PLACE





Scrivania L 180 P 80 con allungo L 100 P 65 cm
Piano scrivania: melaminico rovere chiaro
Gambe: metallo verniciato alluminio
Frontal panel acustico: tessuto JB9806 liquirizia
Desk W 180 D 80 with return W 100 D 65 cm
Worktop: light oak finish melamine
Legs: aluminium painted metal
Acoustic screen: fabric JB9806 liquorice

Workstations
DV804 - E-PLACE



Tavolo riunioni L 300 P 120 cm
Piano: melaminico terra d'ombra
Gambe: metallo verniciato antracite
Meeting table W 300 D 120 cm
Top: umber finish melamine
Legs: anthracite painted metall

Workstations
DV804 - E-PLACE





Tavolo riunioni circolare Ø 120 cm
Piano: melaminico rovere chiaro sp. 25 mm
Gambe free standing: metallo verniciato bianco

Round meeting table Ø 120 cm
Top: light oak finish melamine th. 25 mm
Free standing legs: white painted metal

Workstations
DV804 - E-PLACE



ENTITY

DV801

Un nuovo modo di pensare lo spazio lavorativo. Attuale nei concetti ergonomici della postazione di lavoro, la scrivania DV801-Entity è destinata sia ad uffici operativi che direzionali, promuovendo un ambiente efficiente ed ottimizzato.

Rappresenta la soluzione ideale per chi desidera sfruttare al meglio i propri spazi attraverso composizioni modulari che includono scrivanie in linea, postazioni condivise o tavoli meeting. La scrivania DV801-Entity si caratterizza per la particolare struttura a ponte a sezione triangolare, impreziosita alle estremità da dettagli in ABS ad effetto cromato che conferiscono alla scrivania un aspetto elegante e ricercato. La struttura è disponibile in un'ampia scelta di colori e misure che consentono di configurare tavoli modulari di grandi dimensioni. La collezione è completata da un'ampia gamma di accessori, screens e diverse tipologie di top access per una funzionalità ottimale della workstation.

A new way of conceiving the workspace. Contemporary in its ergonomic workplace concepts, the DV801-Entity desk is intended for both operative and executive office, promoting an efficient and optimised environment. It is the ideal solution for those who wish to optimise their space through modular compositions that include in-line desks, shared workstations or meeting tables. The DV801-Entity desk is characterised by the distinctive triangular section of the bridge structure, enhanced at the ends by chrome-effect ABS details that give the desk an elegant and refined look. The structure is available in a wide choice of colours and sizes which allow large modular tables to be configured. The collection is completed with a wide range of accessories, screens and different top access elements for optimal workstation functionality.



Scrivania L 180 P 80 con allungo L 100 P 65 cm
Piano scrivania e modesty panel: melaminico bianco
Gambe: metallo verniciato antracite
Desk W 180 D 80 with return W 100 D 65 cm
Worktop and modesty panel: white finish melamine
Legs: anthracite painted metal



Gamba a sezione triangolare con dettagli in ABS ad effetto cromato
Triangular-section leg with chrome-effect ABS details

Workstations
DV801 - ENTITY



Scrivania L 200 P 80 cm
Piano scrivania: melaminico bianco
Gambe: metallo verniciato alluminio
Desk W 200 D 80 cm
Worktop: white finish melamine
Legs: aluminium painted metal

Bench L 160 P 158 cm
Piano scrivania: melaminico bianco
Binario centrale in alluminio con sportelli apribili per accesso al cablaggio
Gambe: metallo verniciato alluminio
Mobile di servizio: melaminico alluminio
Ante scorrevoli: melaminico bianco

Workstations
DV801 - ENTITY

Bench W 160 D 158 cm
Worktop: white finish melamine
Aluminium central rail with opening flip doors for wiring access
Legs: aluminium painted metal
Service unit: aluminium finish melamine
Sliding doors: white finish melamine





Bench L 480 P 158 cm
Piano scrivania: melaminico rovere naturale - Top access inclusi
Gambe: metallo verniciato bianco
Frontal panel acustico: tessuto JB9109 pepe
Cassetto sospeso: metallo verniciato bianco. L 32.5 P 52 x H 14.5 cm
Bench W 480 D 158 cm
Worktop: natural oak finish melamine - Top access included
Legs: white painted metal
Acoustic Screen: fabric JB9109 pepper
Hanged drawer: white painted metal. W 32.5 D 52 x H 14.5 cm



Gambe intermedie con carter amovibile per passaggio cavi
Intermediate legs with removable panel for cable management

Workstations
DV801 - ENTITY



Bench L 320 P 166.5 cm
Piano scrivania: melaminico bianco
Profilo centrale in alluminio - Lampade String by Rotoliana
Gambe: metallo verniciato alluminio
Bench W 320 D 166.5 cm
Worktop: white finish melamine
Aluminium central rail - String lamp by Rotoliana
Legs: aluminium painted metal



Workstations
DV801 - ENTITY



Scrivania L 200 P 80 cm
Piano scrivania: vetro temprato sp. 10 mm, retrolaccato acidato
con bordi perimetrali lavorati a filo lucido. Colore bianco
Gambe: metallo verniciato bianco
Desk W 200 D 80 cm
Worktop: 10 mm thick, rear-lacquered and acetated tempered glass
with outer polished edges. White finish
Legs: white painted metal

Tavolo riunioni L 140 P 136.5 cm
Piano: melaminico nero opaco soft touch
Gambe: metallo verniciato antracite
Meeting table W 140 D 136.5 cm
Top: matt black soft touch finish melamine
Legs: anthracite painted metal

Workstations
DV801 - ENTITY



A sinistra e destra: contenitori DV504 - Milo
Sistema di madie, contenitori pensili e barre a muro
Le ante sono fornite con meccanismo di apertura push-pull
Left and right: DV504 - Milo storage units
Sideboard system, hanging units and wall bars
Doors are supplied with push-pull opening mechanism

Workstations
DV801 - ENTITY





Design
ANTONIO MORELLO

ENNA

DV812

Riscoprire il piacere di lavorare in un ambiente flessibile e confortevole, rappresenta il vero futuro e l'innovazione del lavoro ibrido.

La collezione operativa DV812-Enna è l'emblema di questo nuovo modo di concepire l'ufficio, non più confinato, ma esteso ad altri ambienti grazie alla proposta di diverse tipologie di tavoli, forme ed una ampia palette di finiture.

La scrivania si caratterizza da un piano di lavoro a forte spessore (38 mm) e dalla struttura formata unicamente da 4 gambe in metallo colorato disponibili anche in versione con ruote frenate. Una specifica canalina verticale, calamitata alle gambe, consente di celare i cavi elettrici. I tavoli su ruote e i tavoli alti (H 107 cm) promuovono nuovi metodi di lavoro dinamici.

La serie è stata sviluppata per soddisfare al meglio le esigenze di mercato grazie alla semplicità dei componenti e alla velocità di montaggio. Il design moderno e funzionale si adatta alle mutevoli esigenze dell'ufficio, garantendo un ambiente di lavoro ergonomico e confortevole.

Rediscovering the pleasure of working in a flexible and comfortable environment represents the real future and innovation of hybrid work.

The DV812-Enna workstation is the symbol of this new way of conceiving the office, no longer confined, but extended to other environments thanks to the proposal of different types of tables, shapes and a wide palette of finishes.

The desk is characterised by a thick worktop (38 mm) and a structure consisting solely of 4 coloured metal legs that are also available in a version with braked castors.

A special vertical cable duct, magnetised to the legs, allows electrical cables to be hidden. Tables on castors and high tables (H 107 cm) promote dynamic working methods. The series has been developed to best meet the needs of the market thanks to the simplicity of its components and its easy assembly. The modern and functional design adapts to office changing requirements, ensuring an ergonomic and comfortable working environment.



Scrivania L 180 P 80 cm
Piano scrivania: melaminico bianco
Gambe: metallo verniciato bianco
Desk W 180 D 80 cm
Worktop: white finish melamine
Legs: white painted metal



Tavolo riunione ovale L 250 P 125 cm
Piano: melaminico rovere chiaro sp. 38 mm
Gambe: metallo verniciato bianco
Oval meeting table W 250 D 125 cm
Top: light oak finish melamine th. 38 mm
Legs: white painted metal

Workstations
DV812 - ENNA



Bench L 320 P 166.5 cm
Piano scrivania: melaminico rovere naturale sp. 38 mm
Gambe: metallo verniciato rosso mattone
Frontal panel: melaminico antracite sp. 10 mm
Cassetto sospeso: metallo verniciato antracite. L 32.5 P 52 x H 14.5 cm
Bench W 320 D 166.5 cm
Worktop: natural oak finish melamine th. 38 mm
Legs: brick red painted metal
Screen: anthracite finish melamine th. 10 mm
Hanged drawer: anthracite painted metal. W 32.5 D 52 x H 14.5 cm

Contenitori Milo
Sistema di madie, contenitori pensili e barre a muro
Le ante sono dotate di meccanismo di apertura push-pull
Milo storage units
Sideboard system, hanging units and wall bars
The doors have a push-pull opening mechanism

Workstations
DV812 - ENNA





Bench L 320 P 158 cm
Piano scrivania: melaminico bianco - Top access inclusi
Gambe: metallo verniciato bianco
Gambe intermedie con carter amovibile per passaggio cavi
Frontal panel acustico: tessuto JB9804 timo

Bench W 320 D 158 cm
Worktop: white finish melamine - Top access included
Legs: white painted metal
Intermediate legs with removable panel for cable management
Acoustic Screen: fabric JB9804 thyme

Tavoli alti H 107 P 65 cm
Lunghezze disponibili: L 140, 160, 180 cm
Piano: melaminico bianco sp. 38 mm
Gambe: metallo verniciato azzurro polvere
High tables H 107 D 65 cm
Available lengths: W 140, 160, 180 cm
Top: white finish melamine 38 mm thick
Legs: powder blue painted metal



In opzione: canalina verticale in metallo per passaggio cavi
Optional: vertical metal cable duct

Workstations
DV812 - ENNA



Bench integrato a contenitori DV505 - Rio H 116.5 cm
Piano scrivania: melaminico bianco
Gambe: metallo verniciato alluminio
Frontal panel: melaminico antracite sp. 10 mm
Bench integrated with DV505 - Rio storage units H 116.5 cm
Worktop: white finish melamine
Legs: aluminium painted metal
Screen: anthracite finish melamine th. 10 mm



Scrivania L 200 P 90 cm
Piano scrivania: melaminico noce
Gambe: metallo verniciato bianco
Mobile di servizio: DV504 - Milo
Desk W 200 D 90 cm
Worktop: walnut finish melamine
Legs: white painted metal
Service unit: DV504 - Milo



Tavolo riunioni L 240 P 120 cm
Piano: melaminico bianco sp. 38 mm
Gambe: metallo verniciato bianco
Meeting table W 240 D 120 cm
Top: white finish melamine th. 38 mm
Legs: white painted metal

Workstations
DV812 - ENNA



Scrivanie su ruote L 120 P 65 cm
Piano: melaminico rovere chiaro sp. 38 mm
Gambe su ruote con freno: metallo verniciato verde salvia
Desks on castors W 120 D 65 cm
Top: light oak finish melamine th. 38 mm
Legs on castors with brake: metal painted sage green

Workstations
DV812 - ENNA



Tavolo riunioni L 140 P 140 cm
Piano: melaminico rovere chiaro sp. 38 mm
Gambe su ruote con freno: metallo verniciato verde salvia
Meeting table W 140 D 140 cm
Top: light oak finish melamine th. 38 mm
Legs on castors with brake: metal painted sage green



PAG

DV802 W | DV802 A
DV802 U | DV802 O

L'ufficio si libera da ogni vincolo, sociale e strutturale. Diventa un concetto aperto, fisicamente e idealmente. Il sistema di scrivanie DV802-Pag è lo strumento modulare e informale per organizzare e vivere in modo nuovo lo spazio ufficio. Rappresenta la soluzione ideale per chi desidera sfruttare al meglio gli spazi attraverso composizioni modulari che includono scrivanie in linea, postazioni condivise, tavoli meeting e tavoli alti. La scrivania è disponibile con 3 tipi di strutture che ne definiscono l'estetica: gamba a ponte, gamba chiusa e gamba a cavalletto; mentre i materiali impiegati, metallo o legno, suggeriscono contemporaneità o calore domestico. I piani dei bench sono disponibili in tre versioni: piani unici con asole e top access integrati, con uno spazio centrale tra i due piani per accedere facilmente ai collegamenti elettrici e una versione con binario centrale a cui si possono integrare gli accessori e riposizionarli in base alla necessità. Per una privacy individuale, possono essere installati dei pannelli in melaminico, in vetro oppure fonoassorbenti in poliestere termoformato. Versatili nel design, le scrivanie DV802-Pag si prestano a molteplici stili di lavoro sia agili che convenzionali.

The office is freed from all constraints, social and structural. It becomes an open concept, physically and ideally. The DV802-Pag desk system is the modular and informal tool to organize and experience office space in a new way. It is the ideal solution for those who want to make the most of space through modular compositions that include in-line desks, shared workstations, meeting tables and high tables. The desk is available with 3 types of structures that define its aesthetics: bridge leg, loop leg and trestle leg and the materials used, metal or wood, suggest contemporaneity or domestic warmth. The desktops of the shared workstations are available in three versions: one-piece tops with slots and top access, with a central space between the two tops for easy access to electrical connections, and a version with a central rail to which accessories can be integrated and repositioned as required. For individual privacy, melamine, glass or sound-absorbing thermoformed polyester panels can be installed. Versatile in design, the DV802-Pag desks are suitable to a variety of work styles, both agile and conventional.



Bench L 280 P 158 cm
Piano scrivania: melaminico bianco - Top access inclusi
Gambe: massello impiallacciato in rovere naturale - metallo verniciato bianco
Frontal panel acustico: tessuto JB9110 sesamo

Bench W 280 x D 158 cm
Worktop: white finish melamine - Top access included
Legs: solid wood veneered with natural oak - white painted metal
Acoustic screen: fabric JB9110 sesame

Workstations
DV802W - PAG



Bench L 320 P 166.5 cm
Piano scrivania: melaminico bianco
Gambe: massello impiallacciato in rovere naturale - metallo verniciato bianco
Frontal panel acustico: tessuto JB9702 (colore su richiesta)
Bench W 320 D 166.5 cm
Worktop: white finish melamine
Legs: solid wood veneered with natural oak - white painted metal
Acoustic Screen: fabric JB9702 (colour on request)



Scrivania L 180 P 80 con allungo L 100 P 65 cm
Piano scrivania e modesty panel: melaminico bianco
Gambe: massello impiallacciato in rovere naturale - metallo verniciato bianco
Desk W 180 D 80 with return W 100 D 65 cm
Worktop and modesty panel: white finish melamine
Legs: solid wood veneered with natural oak - white painted metal

Workstations
DV802W - PAG



Bench integrato a contenitori orgatower DV505 - Rio P 80 H 115 cm
Piano scrivania: melaminico bianco
Gambe: massello impiallacciato in rovere naturale - metallo verniciato bianco
Frontal panel acustico: tessuto JB9110 sesamo

Bench integrated in DV505 - Rio orgatower storage D 80 H 115 cm
Worktop: white finish melamine
Legs: solid wood veneered with natural oak - white painted metal
Acoustic screen: fabric JB9110 sesame



Orgatower DV505 - Rio
Disponibili in H 74 e 115 cm - P 80 cm

Orgatower DV505 - Rio
Availables in 74 and 115 cm height - D 80 cm

Workstations
DV802W - PAG



Tavolo riunioni modulare L 280 P 136.5 cm
Piano: melaminico bianco
Gambe: massello impiallacciato in rovere naturale - metallo verniciato bianco
Modular meeting table W 280 D 136.5 cm
Top: white finish melamine
Legs: solid wood veneered with natural oak - white painted metal

Workstations
DV802W - PAG



Scrivania L 180 P 90 cm con mobile di servizio antracite
Piano scrivania: melaminico nero opaco soft touch
Gambe: massello rivestito in rovere naturale - metallo verniciato antracite
Desk W 180 D 90 cm with anthracite service cabinet
Worktop: matt black soft touch finish melamine
Legs: solid wood veneered with natural oak - anthracite painted metal



Tavolo riunioni circolare Ø 120 cm
Piano: melaminico nero opaco soft touch sp. 25 mm
Gambe: massello rivestito in rovere naturale - metallo verniciato antracite
Round meeting table Ø 120 cm
Top: matt black soft touch finish melamine th. 25 mm
Legs: solid wood veneered with natural oak - anthracite painted metal

Workstations
DV802W - PAG





Media Table su ruote L 210 P 90 H 200 cm
Piano: melaminico rovere chiaro
Struttura: metallo verniciato antracite
Media Table on castors W 210 D 90 H 200 cm
Top: light oak finish melamine
Structure: anthracite painted metal



High Table su ruote L 210 P 90 H 107 cm
Piano: melaminico rovere chiaro
Struttura: metallo verniciato antracite
High Table on castors W 210 D 90 H 107 cm
Top: light oak finish melamine
Structure: anthracite painted metal

Workstations
DV802 - SOCIAL TABLES



Tavoli alti mobili, connettabili con accessori smart,
che semplificano le molteplici attività di natura relazionale e collettiva.

Piano: melaminico nero opaco soft touch

Struttura: metallo verniciato antracite

Mobile high tables, connectable with smart accessories,
which simplify many social and collective activities.

Top: matt black soft touch finish melamine

Structure: anthracite painted metal

Workstations
DV802 - SOCIAL TABLES



Social Table su ruote L 210 P 90 H 200 cm
Piano: melaminico rovere naturale
Struttura: metallo verniciato bianco
Accessori: portapiante e portabottiglie
Social Table on castors W 210 D 90 H 200 cm
Top: natural oak finish melamine
Structure: white painted metal
Accessories: plant and bottle holders



Accessori amovibili: canalina verticale passacavi,
tappo elettrificato, portabottiglie, portaborsa
Removable accessories: vertical cable duct,
power grommet, bottle holder, bag holder

Workstations
DV802 - SOCIAL TABLES



Scrivania L 180 P 80 con allungo L 100 P 65 cm
Piano scrivania e modesty panel: melaminico rovere naturale
Gambe: metallo verniciato bianco
Desk W 180 D 80 with return W 100 D 65 cm
Worktop and modesty panel: natural oak finish melamine
Legs: white painted metal

Workstations
DV802A - PAG



Scrivania L 180 P 80 cm
Piano scrivania: melaminico bianco
Gambe: metallo verniciato bianco
Frontal panel acustico: tessuto JB9110 sesamo
Desk W 180 D 80 cm
Worktop: white finish melamine
Legs: white painted metal
Acoustic screen: fabric JB9110 sesame

Workstations
DV802A - PAG



Bench L 320 P 166.5 cm
Piano scrivania: melaminico bianco
Gambe: metallo verniciato antracite
Frontal panel acustico: tessuto JB9804 timo
Bench W 320 D 166.5 cm
Worktop: white finish melamine
Legs: anthracite painted metal
Acoustic Screen: fabric JB9804 thyme



Workstations
DV802A - PAG



Tavolo riunione L 240 P 120 cm
Piano: melaminico terra d'ombra
Gambe: metallo verniciato bianco
Meeting table W 240 D 120 cm
Top: umber finish melamine
Legs: white painted metal



Tavolo riunioni circolare Ø 100 cm
Piano: melaminico bianco sp. 25 mm
Gambe: metallo verniciato antracite
Round meeting table Ø 100 cm
Top: white finish melamine th. 25 mm
Legs: anthracite painted metal

Workstations
DV802A - PAG





Scrivania L 180 P 80 con allungo L 100 P 65 cm
Piano scrivania: melaminico rovere chiaro
Gambe: metallo verniciato bianco
Desk W 180 D 80 with return W 100 D 65 cm
Worktop: light oak finish melamine
Legs: white painted metal



Libreria modulare DV528-Kyn L 432 P 42 H 198 cm
Modulo centrale porta TV L 116 H 198 cm - con pannello posteriore per passaggio cavi
Modular bookcase DV528-Kyn W 432 D 42 H 198 cm
Central module TV stand W 116 H 198 cm - with back panel for cable management

Workstations
DV802U - PAG



Bench L 320 P 166.5 cm
Piano scrivania: melaminico bianco
Gambe: metallo verniciato bianco
Frontal panel acustico: tessuto JB9804 timo
Bench W 320 D 166.5 cm
Worktop: white finish melamine
Legs: white painted metal
Acoustic Screen: fabric JB9804 thyme

Workstations
DV802U - PAG



Contenitori terminali
Ante scorrevoli: melaminico rovere chiaro
P 40 H 40 cm (Larghezze disponibili: 136.5, 158, 166.5 cm)
Terminal storage units
Sliding doors: light oak finish melamine
D 40 H 40 cm (available widths: 136.5, 158, 166.5 cm)



Estensioni terminali P 40 cm
Larghezze disponibili: 136.5, 158, 166.5 cm
Terminal tops D 40 cm
Available widths: 136.5, 158, 166.5 cm

Workstations
DV802U - PAG





Bench L 320 P 166.5 cm
Piano scrivania: melaminico bianco
Gambe: metallo verniciato alluminio
Gambe intermedie con carter amovibile per passaggio cavi
Bench W 320 D 166.5 cm
Worktop: white finish melamine
Legs: aluminium painted metal
Intermediate legs with removable panel for cable management



Bench L 320 P 158 cm
Binario centrale in alluminio con 2 sportelli apribili per accesso al cablaggio
Bench W 320 D 158 cm
Aluminium central rail with 2 opening flip doors for wiring access

Workstations
DV802U - PAG



Bench L 180 P 158 cm integrabile con il mobile di servizio
Piano scrivania: melaminico terra d'ombra
Gambe: metallo verniciato antracite
Frontal panel: vetro stratificato sp. 8 mm colore fumé
Bench W 180 D 158 cm to be connected to the service unit
Worktop: umber finish melamine
Legs: anthracite painted metal
Screen: 8 mm thick stratified smoked glass



Scrivania L 200 P 80 - con gambe ad altezza posizionale (65-86 cm)
Piano scrivania: melaminico terra d'ombra
Gambe: metallo verniciato antracite
Desk W 200 D 80 with height adjustable legs (65-86 cm)
Worktop: umber finish melamine
Legs: anthracite painted metal

Workstations
DV802U - PAG





Scrivania L 200 P 80 cm
Piano scrivania: vetro temprato sp. 10 mm, retrolaccato acidato con bordi perimetrali lavorati a filo lucido. Colore nero
Modesty panel: melaminico nero opaco soft touch
Gambe: metallo verniciato antracite
Desk W 200 D 80 cm
Worktop: 10 mm thick, rear-lacquered and acetated tempered glass with outer polished edges. Black finish
Modesty panel: matt black soft touch finish melamine
Legs: anthracite painted metal



Tavolo riunioni modulare L 280 P 136.5 cm
Piano: melaminico noce
Gambe: metallo verniciato antracite
Modular meeting table W 280 D 136.5 cm
Top: walnut finish melamine
Legs: anthracite painted metal

Workstations
DV8020 - PAG



Bench L 320 P 166.5 cm
Piano scrivania: melaminico rovere chiaro
Gambe: metallo verniciato bianco
Contenitori DV545-Seul L 166.5 P 40.5 cm H 74 - 115 - 164.5
Bench W 320 D 166.5 cm
Worktop: light oak finish melamine
Legs: white painted metal
Storage units DV545-Seul W 166.5 D 40.5 cm H 74 - 115 - 164.5



Frontal panel: melaminico bianco sp. 10 mm
Screen: white finish melamine th. 10 mm

Workstations
DV8020 - PAG



Bench L 200 P 166.5 cm comprensivo di estensioni terminali P 40 cm
Piano scrivania: melaminico terra d'ombra
Gambe: metallo verniciato bianco
Frontal panel: melaminico bianco sp. 10 mm
Bench W 200 D 166.5 cm including terminal tops D 40 cm
Worktop: umber finish melamine
Legs: white painted metal
Screen: white finish melamine th. 10 mm



Contenitori DV505 - Rio L 166.5 P 48 H 164.5 cm
DV505 - Rio storages unit W 166.5 D 48 H 164.5 cm

Workstations
DV8020 - PAG





NOBU

DV803

Il mondo del lavoro è in costante evoluzione, una rivoluzione in cui il benessere dell'individuo è al centro del cambiamento. In questo scenario l'ufficio si trasforma e la scrivania DV803-Nobu si adatta ad un nuovo modo di concepire il lavoro. DV803-Nobu è un sistema di scrivanie caratterizzato da 4 tipologie di struttura: ad altezza fissa (H 74 cm), regolabile in altezza tramite pulsante (H 65÷86 cm), a manovella (H 65÷112 cm), e su ruote con piano ribaltabile. La struttura metallica è composta da due gambe a "T" rovesciata e da una trave telescopica che accoglie orizzontalmente i cavi. I tavoli folding sono dotati di ruote frenate, agganciabili tra loro e integrati di un sistema che consente al piano di ruotare e di chiudersi per occupare il minor spazio possibile. La linea minimale della scrivania DV803-Nobu ridisegna l'estetica dello spazio, senza rinunciare all'ergonomia e al benessere. I materiali utilizzati sono riciclabili e i tavoli sono facilmente disassemblabili per un corretto riciclaggio al termine della loro vita.

The world of work is constantly evolving, a revolution in which the well-being of the individual is at the centre of change. In this scenario, the office is transformed and the DV803-Nobu desk adapts to a new way of conceiving work. The DV803-Nobu is a desk system characterised by 4 types of structure: fixed height (H 74 cm), height-adjustable by push-button (H 65÷86 cm), crank-mounted (H 65÷112 cm), and on castors with a tilting top. The metal structure consists of two inverted 'T' legs and a telescopic beam that holds the cables horizontally. The folding tables are equipped with braked castors, hook together and are provided of a system that allows the desktop to swivel and fold to occupy as little space as possible. The minimalist design of the DV803-Nobu desk redefines the aesthetics of the space without sacrificing ergonomics and well-being. The materials used are recyclable and the desks are easily disassembled for proper end-of-life recycling.



Scrivania L 180 P 80 con allungo L 100 P 65 cm
Piano scrivania: melaminico rovere chiaro
Gambe: metallo verniciato bianco
Desk W 180 D 80 with return W 100 D 65 cm
Worktop: Light oak finish melamine
Legs: white painted metal



Tavolo riunione ovale L 250 P 125
Piano: melaminico rovere chiaro
Gambe: metallo verniciato bianco
Oval meeting table W 250 D 125
Top: Light oak finish melamine
Legs: white painted metal

Workstations
DV803 - NOBU



Scrivania Nobu ad altezza fissa H 74 cm
Scrivania Nobu regolabile in altezza con pulsante (65÷86 cm)
Scrivania Nobu regolabile in altezza a due stadi, con manovella (74÷112 cm)
Nobu desk H 74 cm
Nobu height-adjustable desk with push-button (65÷86 cm)
Nobu height adjustable two-stage desk with crank (74÷112 cm)

Workstations
DV803 - NOBU



Scrivania L 180 P 80 - altezza posizionabile con pulsante (65÷86 cm)
Piano scrivania: melaminico bianco
Gambe: metallo verniciato bianco
Cassetto sospeso: metallo verniciato bianco. L 32.5 P 52 x H 14.5 cm
Desk W 180 D 80 - adjustable height with button (65÷86 cm)
Worktop: white finish melamine
Legs: white painted metal
Hanged drawer: white painted metal. W 32.5 D 52 x H 14.5 cm



Scrivania L 180 P 80 regolabile in altezza a due stadi con manovella (74÷112 cm)
Piano scrivania: melaminico bianco
Gambe: metallo verniciato antracite
Frontal panel acustico: tessuto JB9804 timo
Desk W 180 D 80 - Crank-adjustable height (74÷112 cm)
Worktop: white finish melamine
Legs: anthracite painted metal
Acoustic Screen: fabric JB9804 thyme



Regolazione con manovella estraibile
La manovella può essere installata a destra o a sinistra della scrivania
Adjustment with pull-out crank
The crank can be installed on the right or left of the desk

Workstations
DV803 - NOBU



Tavolo riunione modulare L 360 P 360 cm
Piano: melaminico bianco
Gambe: metallo verniciato alluminio
Modular meeting table W 360 D 360 cm
Top: white finish melamine
Legs: aluminium painted metal



Tavolo riunione rettangolare L 240 P 120 cm
Piano: melaminico bianco
Gambe: metallo verniciato bianco
Rectangular meeting table W 240 D 120 cm
Top: white finish melamine
Legs: white painted metal

Workstations
DV803 - NOBU



Tavoli su ruote con freno e piano ribaltabile
Profondità piani: 70 e 80 cm
Modesty panel in tessuto: nero
Pannelli fonoassorbenti per soffitto: tessuto JB9110 sesamo
Tables on castors with brakes and tilting top
Top depths: 70 and 80 cm
Textile modesty panel: black
Soundproof roof panel: fabric JB9110 sesame



Tavoli su ruote con freno e piano ribaltabile
Piano scrivania: melaminico terra d'ombra
Gambe: metallo verniciato bianco
A destra: ganci per collegare in linea i tavoli pieghevoli
Tables on castors with brakes and tilting top
Worktop: Umber finish melamine
Legs: white painted metal
Right side: hooks to connect folding tables in line





TOLEDO

DV818

Molto più di una semplice scrivania, DV818-Toledo è l'espressione tangibile di una nuova visione lavorativa flessibile che preserva il benessere della persona. Un sistema di tavoli regolabili in altezza elettricamente che unisce funzionalità, comfort ed ergonomia.

La scrivania DV818-Toledo può essere regolata in altezza autonomamente H 64,5÷130 cm, mentre il bench H 61,5÷127,5 cm. Tastierino dotato di 4 memorie per la regolazione dell'altezza del piano di lavoro. La regolazione in altezza a 3 stadi, rapida e silenziosa, consente di alternare facilmente la postura seduta a quella eretta, adattando la tecnologia alle esigenze fisiche individuali.

La trave è telescopica e canalizzabile.

Il sistema di gestione dei cavi (disponibile in diverse soluzioni) garantisce un risultato preciso e ordinato. Le scrivanie possono essere integrate con pannelli fonoassorbenti in poliestere termoformato o melaminico, garantendo una privacy individuale. Con il suo design e l'ampia scelta di finiture, si adatta in modo intelligente alle esigenze della persona, abbracciando benessere ed innovazione.

Much more than a simple desk, the DV818-Toledo is the tangible expression of a new vision of flexible working that preserves personal well-being. An electrical height-adjustable desk that combines functionality, comfort and ergonomics.

The DV818-Toledo desk can be adjusted in height independently H 64.5÷130 cm while the bench H 61.5÷127.5 cm. Control pad with 4 memories for height adjustable worktop. The quick and silent 3-stage height adjustment allows easy switching between sitting and standing positions, adapting the technology to individual physical needs.

The beam is telescopic and can be ducted with cables. The cable management system (available in several versions) offers a neat and tidy look. The desks can be completed with sound-absorbing panels in thermoformed polyester or melamine, ensuring individual privacy. With its design and wide choice of finishes, it adapts to people's needs in an ingenious way, embracing wellness and innovation.

Bench L 180 P 166.5 cm. Regolazione elettrica in altezza a tre stadi (61.5÷127.5 cm)
Piano scrivania: melaminico rovere naturale
Gambe: metallo verniciato bianco
Frontal panel: in melaminico rivestito in tessuto JB9109 pepe

Sit stand bench W 180 D 166.5 cm. Electric three-stage height adjustment (61.5÷127.5 cm)
Worktop: natural oak finish melamine
Legs: white painted metal
Screens: in melamine covered with fabric JB9109 pepper





Kit unione bench in linea
Vertebra passacavi per bench
Passacavi verticale a spirale
Side linking unit for bench
Cable management chain for bench
Vertical spiral cable duct

Workstations
DV818 - TOLEDO



Scrivania L 180 P 80 con allungo L 100 P 65 cm.
Regolazione elettrica in altezza
a tre stadi (64.5÷130 cm)
Piano scrivania: melaminico
nero opaco soft touch
Gambe: metallo verniciato antracite
Frontal panel acustico: tessuto JB9109 pepe
Sit stand desk W 180 D 80 with return W 100
D 65 cm. Electric three-stage height
adjustment (H 64.5÷130 cm)
Worktop: matt black soft touch
finish melamine
Legs: anthracite painted metal
Acoustic Screen: fabric JB9109 pepper



Dimensioni:
Lunghezze scrivania: L 120, 140, 160, 180 cm
Profondità scrivania: P 65, P 80 cm
Pannelli fonoassorbenti a muro:
tessuto JB9109 pepe - JB9110 sesamo - JB9804 timo
Dimensions:
Desk lengths: W 120, 140, 160, 180 cm
Desk depths: D 65, D 80 cm
Soundproof wall panels:
fabric JB9109 pepper - JB9110 sesame - JB9804 thyme

Workstations
DV818 - TOLEDO





Bench L 180 P 166.5 cm. Regolazione elettrica in altezza a tre stadi (61.5÷127.5 cm)

Piano scrivania: melaminico bianco

Gambe: metallo verniciato alluminio

Frontal panel: melaminico rivestito in tessuto JB9804 timo

Orgatower: L 42 P 80 x H 115 cm

Sit stand bench W 180 D 166.5 cm. Electric three-stage height adjustment (H 61.5÷127.5 cm)

Worktop: withe finish melamine

Legs: aluminium painted metal

Screens: melamine covered with fabric JB9804 thyme

Orgatower: W 42 D 80 x H 115 cm



Tastierino per regolazione altezza scrivania con 4 memorie

Trave telescopica e canalizzabile: colore alluminio

Control pad with 4 memories for height adjustable desk

Telescopic and ducting beam: aluminium painted metal

Workstations

DV818 - TOLEDO





Design
ANTONIO MORELLO

TREKO

DV805

Praticità e flessibilità, sono i plus che consentono di arredare i moderni spazi di lavoro. L'ufficio diventa un luogo da ripensare tra funzionalità ed ergonomia, un ambiente che incentivi la produttività.

Le linee pulite e senza tempo della scrivania pannellata operativa DV805-Treko si integrano perfettamente in questo contesto. Una scrivania dal design classico e basilare, adatta a gestire razionalmente i diversi spazi di lavoro.

Grazie alle molteplici combinazioni tra finiture e dimensioni, le scrivanie DV805-Treko rispondono ai bisogni essenziali dei nuovi layout progettuali. I tavoli sono realizzati con materiali durevoli e di qualità certificata, a vantaggio della sostenibilità. Ideale per ambienti openspace, le scrivanie possono essere integrate di frontal panel fonoassorbenti in poliestere termoformato o in melaminico, che garantiscono una privacy individuale.

Practicality and flexibility are the plus points of modern workspaces. The office becomes a place to rethink between functionality and ergonomics, an environment that encourages productivity. The clean, timeless lines of the DV805-Treko operative panelled desk fit perfectly into this context. A desk with a classic and simple design, adapted to rationally manage different work environments. Thanks to the multiple combinations of finishes and sizes, the DV805-Treko workstations meet the essential needs of new design layouts. The desks are made of durable, quality-certified materials for the benefit of sustainability. Ideal for openspace environments, the desks can be equipped with sound-absorbing screens in thermoformed polyester or melamine, that provide individual privacy.



Tavolo riunione ovale L 250 P 125 cm con top access centrale incluso
Melaminico rovere chiaro
Oval meeting table W 250 D 125 cm with central top access included
Light oak finish melamine



Scrivania L 200 P 100 cm
Melaminico noce
Mobile di servizio indipendente in melaminico antracite
L 160 P 48 x H 58 cm
Desk W 200 D 100 cm
Walnut finish melamine
Freestanding service cabinet in anthracite finish melamine
W 160 D 48 x H 58 cm



Scrivania L 200 P 80 cm con raccordo 90° e scrivania L 80 P 80 cm
Melaminico nero opaco soft touch
Desk W 200 D 80 cm with 90° connection and desk W 80 D 80 cm
Matt black soft touch finish melamine

Workstations
DV805 - TREKO



Tavolo riunioni L 240 P 120 cm con top access centrale incluso
Melaminico rovere chiaro
Meeting table W 240 D 120 cm with central top access included
Light oak finish melamine

Workstations
DV805 - TREKO



Tavoli alti H 107 P 80 cm
Lughezze disponibili: L 140, 160, 180 cm
Piano: melaminico bianco
Gambe pannellate: melaminico bianco
High tables H 107 D 80 cm
Available lengths: W 140, 160, 180 cm
Top: white finish melamine
Panelled Legs: white finish melamine



Top access con sportello apribile su due lati
Top access with double-sided opening flap

Workstations
DV805 - TREKO





Design
ANTONIO MORELLO

OSLO

DV817

Semplicità ed essenzialità, con un design incisivo e riconoscibile, rendono la scrivania DV817-Oslo adatta a qualsiasi spazio di lavoro. La struttura metallica è composta da due gambe a "T" rovesciata a sezione rotonda e da una trave in metallo ad innesto rapido senza uso di viti. La gamba presenta alla base 2 piedini rotondi in ABS colorato che connotano stilisticamente il prodotto in abbinamento al colore della gamba oppure a contrasto. La struttura dei bench dispone di gambe intermedie condivise che grazie alla loro dimensione e forma non recano intralcio all'operatore. Una specifica canalina verticale calamitata alle gambe consente di celare i cavi. DV817-Oslo propone soluzioni trasversali di tavoli alti e tavolini caffè che consentono di progettare aree break e spazi collaborativi, per dare un maggiore comfort all'ufficio contemporaneo. I materiali utilizzati sono riciclabili e i tavoli facilmente disassemblabili per consentirne il corretto riciclaggio al termine della loro vita.

Simplicity and essentiality, with an incisive and recognisable design, make the DV817-Oslo desk suitable for any workspace. The metal structure is made up of two inverted 'T'-shaped legs with a round cross-section, and a screwless metal beam. The leg has 2 round coloured ABS feet at the base, which stylistically characterise the product either matched to the colour of the leg or in contrast. The structure of the benches has shared intermediate legs, which, due to their size and shape, do not hinder the operator. A specific vertical channel magnetised to the legs hides the cables. DV817-Oslo offers versatile solutions of high tables and coffee tables that design break areas and collaborative spaces to add comfort to the contemporary office. The materials used are recyclable and the tables are easily disassembled to allow for proper recycling at the end of their life.



Bench L 320 P 166.5 cm
Piano scrivania: melaminico bianco
Gambe: metallo verniciato alluminio
Frontal panel: melaminico alluminio sp. 10 mm
Bench W 320 D 166.5 cm
Worktop: white finish melamine
Legs: aluminium painted metal
Screen: aluminium finish melamine th. 10 mm.



Tavoli alti Ø 80 H 107 cm
Tavolini caffè Ø 80 H 45 cm
Piano: melaminico bianco
Gambe: metallo verniciato antracite
High tables Ø 80 H 107 cm
Coffee tables Ø 80 H 45 cm
Top: white finish melamine
Legs: anthracite painted metal



Workstations
DV817 - OSLO

Scrivania L 180 P 80 cm
Piano scrivania: melaminico terra d'ombra
Gambe: metallo verniciato bianco
Desk W 180 D 80 cm
Worktop: Umber finish melamine
Legs: white painted metal



Contenitore DV505 - Rio L 166.5 P 48 H 74 cm
Piano scrivania: melaminico rovere naturale
Gambe: metallo verniciato bianco
Frontal panel acustico: tessuto JB9109 pepe
DV505 - Rio storage unit W 166.5 D 48 H 74 cm
Worktop: natural oak finish melamine
Legs: white painted metal
Acoustic Screen: fabric JB9109 pepper

Workstations
DV817 - OSLO



Scrivania L 180 P 80 cm con mobile di servizio
Piano scrivania: melaminico noce
Gambe: metallo verniciato bianco
Desk W 180 D 80 cm with service cabinet
Worktop: walnut finish melamine
Legs: white painted metal



Tavolo riunioni circolare Ø 120 cm
Piano: melaminico noce
Gambe: metallo verniciato bianco
Round meeting table Ø 120 cm
Top: walnut finish melamine
Legs: white painted metal



Workstations
DV817 - OSLO

Tavolo riunione ovale L 250 P 125 cm
Piano: melaminico noce
Gambe: metallo verniciato bianco
Contenitori DV504 - Milo
Oval meeting table W 250 D 125 cm
Worktop: walnut finish melamine
Legs: white painted metal
DV504 - Milo storage units



Workstations
DV817 - OSLO





Design
ANTONIO MORELLO

NIDA

DV816

Il lavoro ibrido e smart emerge come il futuro del quotidiano lavorativo, con l'individuo al centro di questa trasformazione. In questa nuova era, il concetto tradizionale di ufficio lascia spazio a luoghi di lavoro sempre più eterogenei.

Il tavolo DV816-Nida, concepito sia per l'home office che per ambienti di formazione, si adatta a questa trasformazione grazie alle sue dimensioni compatte e alla facilità di assemblaggio. La struttura è costituita da una gamba in tubolare metallico disponibile in diverse finiture, mentre il piano di lavoro è sagomato con spigoli arrotondati. In opzione, si possono aggiungere due carter frontali in metallo, uniti tra loro mediante un cordoncino elastico, con funzione di contenere i cablaggi e assicurare maggiore privacy. Accessori quali piccole mensole e cassetto, personalizzano lo scrittoio. DV816-Nida unisce estetica e benessere fisico, creando un ambiente di lavoro libero da schemi progettuali.

Hybrid and smart work are emerging as the future of everyday work, with people at the centre of this transformation. In this new era, the traditional office concept gives way to increasingly heterogeneous workplaces. The DV816-Nida table, designed for home office and for training environments, adapts to this transformation thanks to its compact dimensions and easy assembly. The structure consists of a tubular metal leg available in different finishes, and the worktop is shaped with rounded edges. Optionally, two metal front covers can be added, joined together by an elastic cord, to contain wiring and provide greater privacy. Accessories such as small shelves and a drawer customise the desk. The DV816-Nida combines aesthetics and physical well-being, creating a working environment free of design schemes.

Scrivania L 140 P 65 cm
Piano scrivania: melaminico bianco
Gambe: metallo verniciato bianco
Desk W 140 D 65 cm
Worktop: white finish melamine
Legs: white painted metal

Workstations
DV816 - NIDA



Scrivania L 140 P 65 cm
Piano scrivania: melaminico nero opaco soft touch
Gambe: metallo verniciato antracite
Schermi metallici: disponibili nei colori bianco, antracite o azzurro polvere
Cassetto: metallo verniciato bianco
Desk W 140 D 65 cm
Worktop: matt black soft touch finish melamine
Legs: anthracite painted metal
Metal screens: available in white, anthracite or powder blue
Drawer: white painted metal



Accessori: in metallo colore bianco
Vengono allineati allo schermo metallico mediante calamite
Accessories: in white metal
They are aligned to the metal screen by magnets

Workstations
DV816 - NIDA



SHELL SYSTEM

DV650

La collezione DV650-Shell è un sistema di arredo multifunzionale che ridefinisce l'ambiente di lavoro e rappresenta un safe space all'interno dell'openspace.

Il sistema si sviluppa partendo dal concetto di privacy della tradizionale paretina disposta intorno alla scrivania sino ad arrivare alla progettazione di piccoli "Pod", includendo un sistema di sedute componibili pensate per le aree collaborative.

Il denominatore comune è l'importanza posta sulla privacy, sulla comunicazione e sul benessere psicofisico della persona.

In base alla configurazione scelta, i Pod possono fungere da stanze per video-conferenze, zone di relax o multifunzione.

I Pod sono versatili e facili da installare, senza dover effettuare ulteriori lavori all'edificio.

La struttura è costituita da pannelli in melaminico sp. 25 mm con una texture materica ad effetto "tessuto" per una gradevole sensazione tattile e visiva, e bordi perimetrali in ABS. Per un maggiore comfort e insonorizzazione acustica, in opzione, sono disponibili delle lastre di poliestere termoformato da applicare sulle pareti interne dei Pod.

The DV650-Shell collection is a multifunctional furniture system that redefines the working environment and represents a safe space within the open space.

The system develops from the privacy concept of the traditional partition around the desk to the design of small 'pods', including a modular seating block system designed for collaborative areas.

The common denominator is the importance placed on privacy, communication and the psycho-physical well-being of the individual. Depending on the configuration chosen, the Pods can serve as video-conference rooms, breakout zones or multifunctional areas.

The Office Pod are versatile and easy to install, without having to carry out any additional work on the building.

The structure consists of 25 mm thick melamine panels with a textured 'fabric' effect for a pleasant tactile and visual sensation, and ABS perimeter edges. For added comfort and acoustic soundproofing, there are optional thermoformed polyester sheets to be applied to the interior sides of the Pods.



Paretine L 160 cm H 147 cm
Pannelli: melaminico trama grigio
Pannelli in feltro in opzione
Office Cubicle W 160 H 147 cm
Panels: grey fabric texture melamine
Optional felt panels



Paretine L 160 cm H 180 cm
Fianco di chiusura L 65 H 114 cm
I montanti per angoli consentono di collegare pannelli di altezze diverse
Office Cubicle W 160 H 180 cm
Closing side panel W 65 H 114 cm
Corner uprights can be used to join panels of different heights



Workstations
DV650 - SHELL SYSTEM

Piccoli nuclei per una maggiore privacy, per interagire,
per collaborare e vivere il proprio ufficio che non conosce vincoli fisici.
Small units for more privacy, to interact,
to collaborate and to live in an office that knows no physical constraints.

Office Pod configurabili
Dimensioni:
L 165 P 100 H 220 cm
L 165 P 140 H 220 cm
Configurable Office Pods
Dimensions:
W 165 D 100 H 220 cm
W 165 D 140 H 220 cm

Workstations
DV650 - SHELL SYSTEM



Office Pod L 165 P 140 H 220 cm
Pannelli: melaminico trama grigio
Panca con cuscino e schienale rivestito in tessuto
Tavolo L 137 P 60 H 74 cm
Office Pod W 165 D 140 H 220 cm
Panels: grey fabric texture melamine
Bench with fabric-covered cushion and backrest
Table W 137 D 60 H 74 cm

Luce a Led (di serie)
In opzione:
Box alimentazione predisposto per 2 prese
Cuscino per panca L 137 P 39 H 3 cm (in poliestere termoformato)
Cuscino per panca e schienale L 137 P 3 H 127 cm
Led light (standard)
Optional:
Power box arranged for 2 sockets
Seat cushion for bench W 137 D 39 H 3 cm (in thermoformed polyester)
Bench and backrest cushion W 137 D 3 H 127 cm

Workstations
DV650 - SHELL SYSTEM

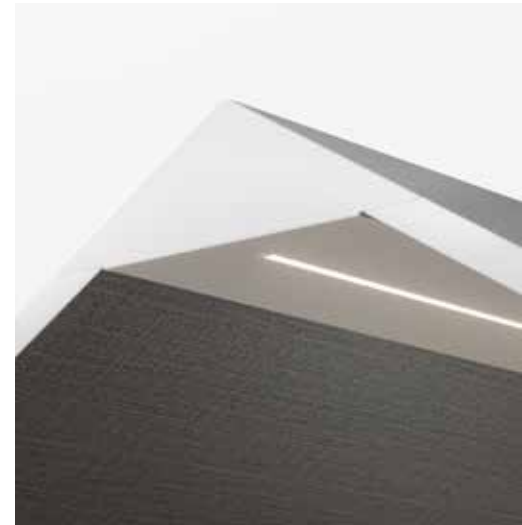



Moduli seduta componibili
Elementi assemblabili e multifunzione,
pensati come panca, tribuna e contenitori portapiante
Modular seating blocks
Assemblable, multifunctional elements designed as benches,
grandstands and plant containers

Workstations
DV650 - SHELL SYSTEM



Moduli seduta componibili: L - P 45, 90, 135 - H 45 cm
Pannelli: melaminico trama grigio
Cuscino amovibile 39 x 39 cm
Prese elettriche in opzione
Modular seating blocks: W - D 45, 90, 135 - H 45 cm
Panels: grey fabric texture melamine
Removable cushion 39 x 39 cm
Optional electrical outlets

Workstations
DV650 - SHELL SYSTEM



Multimedia

E-MEDIA

DV401

L'evoluzione delle tecnologie sta trasformando il modo di lavorare e gli ambienti della nostra vita professionale, facendoli diventare luoghi confortevoli in cui le persone possono incontrarsi e collaborare pur essendo fisicamente distanti. DV401-E-Media è un tavolo riunione multifunzione, progettato per riunioni in presenza o virtuali, sia seduti che in piedi e proposto in due altezze (H. 174 e H. 207 cm). Il fusto portante in melaminico può contenere, al suo interno, i cablaggi che accedono dalla parte inferiore attraverso i tappi passacavi diametro 80 mm. Il vano è ispezionabile mediante l'apertura del pannello superiore sottopiano. Il piano è in melaminico sp. 25 mm, sagomato a forma trapezoidale per consentire a tutti una corretta visione del monitor. È disponibile in due lunghezze (L.142 e L.202 cm) ed è fornito di top access centrale con apertura a slitta. In fase di montaggio è possibile scegliere, tra 2 altezze predefinite. DV401-E-Media unisce funzionalità e tecnologia, creando un ambiente di lavoro sempre più interconnesso.

The evolution of technology is transforming the way we work and the environments of our professional lives, making them become comfortable places where people can meet and collaborate despite being physically distant. The DV401-E-Media is a multifunctional meeting table, available in two heights (H. 174 and H. 207 cm), designed for in-person or virtual meetings, either seated or standing. The melamine supporting frame can contain, inside, the wiring which can be accessed through the 80 mm diameter grommets installed at the base. Inspection inside of the vertical column is possible through the opening of the panel under the tabletop. The top is made of 25 mm thick melamine, shaped in a trapezoidal shape to allow everyone a correct view of the monitor. It is available in two lengths (L.142 and L.202 cm) and is equipped with a central top access with slide opening. During assembly it is possible to choose the position of the monitor bracket between 2 predefined heights. DV401-E-Media combines functionality and technology, creating an increasingly interconnected working environment.



E-Media L 202.5 P 160 H 207 cm
Piano: melaminico rovere naturale
Schiena verticale: melaminico bianco
Basamento: melaminico bianco
Vano ispezionabile di serie (lato sx)
E-Media W 202.5 D 160 H 207 cm
Worktop: natural oak finish melamine
Back panel: white finish melamine
Base: white finish melamine
Standard inspection compartment (left side)



Piano L 142.5 P 160 cm
Top access incluso
Worktop W 142.5 D 160 cm
Top access included

Multimedia
DV401 - E-MEDIA



E-Media L 202.5 P 160 H 207 cm
Piano: melaminico bianco
Schiena verticale: melaminico bianco
Basamento: melaminico bianco
E-Media W 202.5 D 160 H 207 cm
Worktop: white finish melamine
Back panel: white finish melamine
Base: white finish melamine



E-Media L 202.5 P 160 H 174 cm
Piano: melaminico nero opaco soft touch
Schiena verticale: melaminico bianco
Basamento: melaminico bianco
E-Media W 202.5 D 160 H 174 cm
Worktop: matt black soft touch finish melamine
Back panel: white finish melamine
Base: white finish melamine

Multimedia
DV401 - E-MEDIA





Design
ANTONIO MORELLO

MOBILE WALL

DV420

In ogni ufficio le persone interagiscono attraverso la tecnologia e collaborano, con arredi multifunzionali, in ambienti che possono essere reali o virtuali, destinati a piccole o grandi riunioni, in luoghi aperti o chiusi. DV420-Mobile Wall è un carrello portamonitor, autoportante, su ruote con freno, progettato per fungere anche come elemento divisorio degli spazi. Rappresenta il simbolo del lavorare in modo flessibile, definendo nuovi layout, ottimizzando e riconfigurando gli spazi in luoghi di formazione o meeting room. La struttura in metallo verniciato è disponibile in H 180 e L 120 cm, ed entrambi i lati possono essere personalizzati con supporti per monitor o lavagne.

È dotata di 2 ripiani centrali fissi e due pratici contenitori metallici posti alle estremità. Ai fianchi, è possibile applicare alcuni accessori quali mensole, portapenne o ganci appendiabiti. Una specifica canalina verticale, calamitata alla struttura, consente di celare i cavi elettrici. Grazie alla sua flessibilità, DV420-Mobile Wall è in perfetta sintonia con i requisiti mutevoli del mondo del lavoro moderno.

In every office, people interact through technology and collaborate, with multifunctional furniture, in environments that can be real or virtual, for small or large meetings, in open or enclosed spaces.

The DV420-Mobile Wall is a free-standing monitor trolley, on castors with brakes, designed to also function as a space divider. It represents the symbol of flexible working, defining new layouts, optimising and reconfiguring spaces in training or meeting rooms.

The painted metal frame is available in H 180 and W 120 cm, and both sides can be customised with supports for monitors or whiteboards.

It is equipped with 2 fixed central shelves and two practical metal containers.

Some accessories such as shelves, pen holders or clothes hooks can be attached to the sides.

A special vertical cable duct, magnetised to the structure, allows the hiding of electrical cables.

Thanks to its flexibility, the DV420-Mobile Wall is perfectly adapted to the changing requirements of the modern working world.

Mobile wall L 120 P 42 H 180 cm
Struttura su ruote: metallo verniciato antracite
Con lavagna
Con portamonitor (50" max)
Accessoriabile su 2 lati

Mobile wall W 120 D 42 H 180 cm
Structure on castors: anthracite painted metal
With whiteboard
With monitor holder (50" max)
Accessorisable on 2 sides

Multimedia
DV420 - MOBILE WALL



Canalina verticale
Vertical cable duct



Accessori: Carter di copertura staffe, Gancio, Portapenne, Portaoggetti
Accessories: Bracket cover, Hook, Pen holder, Object holder

Multimedia
DV420 - MOBILE WALL

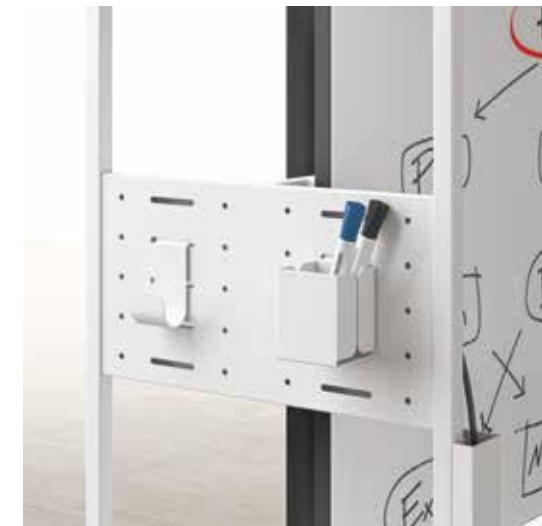

Specifiche Tecniche Technical Sheets

Workstations	E-PLACE DV804	p. 212
	ENTITY DV801	p. 216
	ENNA DV812	p. 220
	PAG DV802	p. 226
	NOBU DV803	p. 234
	TOLEDO DV818	p. 240
	TREKO DV805	p. 244
	OSLO DV817	p. 248
	NIDA DV816	p. 252
UNIVERSAL MEETING TABLES DV990	p. 254	
SHELL SYSTEM DV650	p. 258	
<hr/>		
Multimedia	E-MEDIA DV401	p. 264
	MOBILE WALL DV420	p. 266
<hr/>		
Wire Management DV300		p. 270
<hr/>		
Plug&Play DV300		p. 282



DV804 - E-PLACE

Finiture Finishes

Scrivania - Tavoli riunione Desk - Meeting tables

M Piani scrivania sp. 25 mm e modesty panel sp. 18 mm
Worktops th. 25 mm and modesty panel th. 18 mm

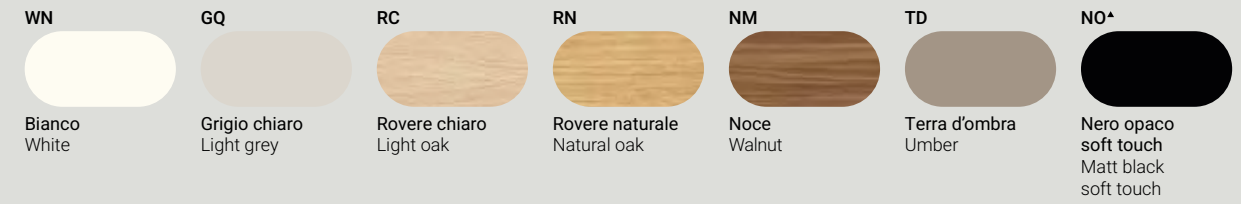

MD Piano riunione 100x100 cm - Piano riunione Ø 60 cm
Meeting worktops 100x100 cm - Meeting worktops Ø 60 cm

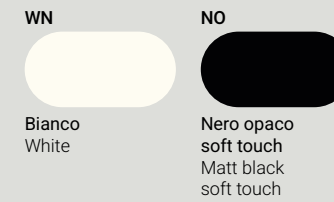

MT Gambe metalliche
Metal legs



MT Travi in metallo
Metal beams



LEGENDA LEGEND

M Melaminico
Melamine

MD MDF + Rivestito in melaminico
MDF + Melamine coated

MT Metallo
Metal

* Non in pronta consegna
* Not in prompt delivery

* Esclusi L 240/L 300 P 120
* Not available for W 240/W 300 D 120

Dati tecnici
Technical data

Scrivania
Desks

Scrivania P 65 - Scrivania da collegare in linea
D 65 desk - In-line connectable desk

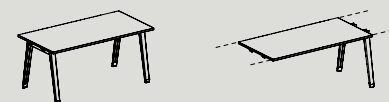

L/W	80	P/D	65	H/H	74
	100				
	120				
	140				
	160				
	180				

Scrivania P 80 - Scrivania da collegare in linea
D 80 desk - In-line connectable desk



L/W	140	P/D	80	H/H	74
	160				
	180				
	200				

Modesty panel Dx/R e Sx/L
R/L Modesty panel

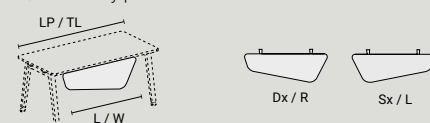

LP/TL	140	L/W	110	P/D	2	H/H	38
	160		110				
	180		140				
	200		140				

Allungo laterale P 65
D 65 desk return

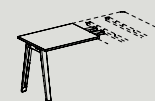

L/W	80	P/D	65	H/H	74
	100				

Allungo con cassettera portante - 3/4 cassetti
Return with high pedestal - 3/4 drawers

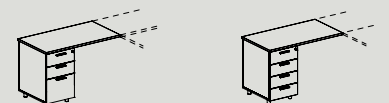

L/W	100	P/D	65	H/H	74
	120				

Raccordo 90° 2 vie curvo - Per scrivania P 80
90° 2-way curved connection - For desk D 80

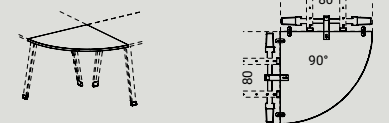

L/W	80	P/D	80	H/H	2.5
-----	----	-----	----	-----	-----

Scrivanie P 65 - P 80 integrabili con mobile di servizio
D 65 - D 80 desks to be connected to the service unit

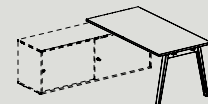

L/W	140	P/D	65	H/H	74
	160		80		
	180				

Bench - Accessori - Tavoli riunione
Benches - Accessories - Meeting tables

Bench P 136.5 - P 166.5
D 136.5 - D 166.5 benches



L/W	140	P/D	136.5	H/H	74
	160		166.5		
	180				

Bench P 158 - Con binario centrale - 2 sportelli
D 158 benches - With central rail - 2 flip doors

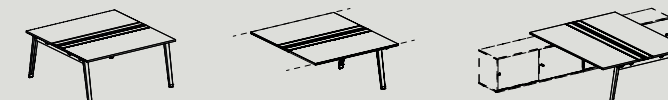

L/W	140	P/D	158	H/H	74
	160				
	180				

Binario centrale con staffe per bench P 136.5 - P 166.5
Central rail with brackets for D 136.5 - D 166.5 benches

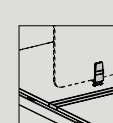

L/W	140	P/D	6.5	H/H	1.8
	160				
	180				

Piano terminale per bench ^R
Lateral top for benches



L/W	136.5	P/D	40	H/H	2.5
	158				
	166.5				

Tavoli riunione quadrati P 100 ^{MD} - P 140 ^R
D 100 ^{MD} - D 140 ^R squared meeting tables



L/W	100	P/D	100	H/H	74
	140		140		74

Tavoli riunione rettangolari P 120 ^R
D 120 rectangular meeting tables

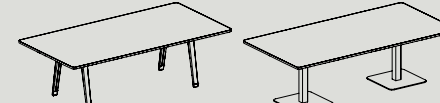

L/W	240	P/D	120	H/H	74
	300				

Tavoli riunione circolari Ø 60 ^{MD} - Ø 100 - Ø 120
Ø 60 ^{MD} - Ø 100 - Ø 120 round meeting tables

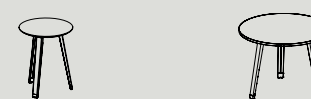

L/W	60	P/D	60	H/H	74
	100		100		74
	120		120		



DV801 - ENTITY

Finiture Finishes

Scrivania Desk

M Piani scrivania e modesty panel sp. 18 mm
Worktops and modesty panel th. 18 mm

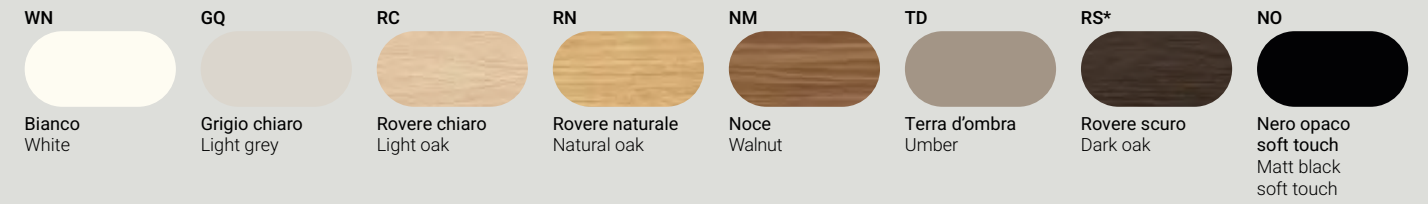

MT Solo per modesty panel sp. 18 mm
Only for modesty panel th. 18 mm



V Piani scrivania sp.10 mm in vetro temprato retrolaccato acidato
Worktops th.10 mm in rear-lacquered acetated tempered glass

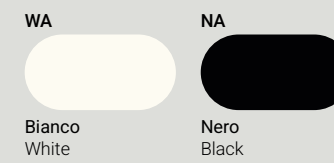

MT Gambe metalliche
Metal legs



MT Travi in metallo
Metal beams

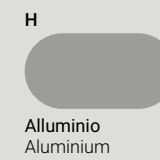

P Tappi e piedini in ABS per gamba
ABS caps and feet for leg

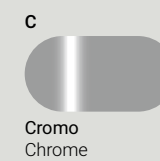

LEGENDA LEGEND

M Melaminico Melamine	P ABS/Plastica Plastic/ABS
MT Metallo Metal	V Vetro Glass

* Non in pronta consegna
* Not in prompt delivery

Dati tecnici
Technical data

Scrivania
Desks

Scrivania P 65 - P 80
D 65 - D 80 desk



L/W	80	P/D	65	H/H	74
	100		80		
	120				
	140				
	160				
	180				
	200				

Scrivania P 65 - 80 da collegare in linea
D 65 - D 80 in-line connectable desk

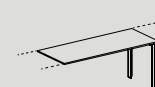

L/W	80	P/D	65	H/H	74
	100		80		
	120				
	140				
	160				
	180				
	200				

Scrivania P 90
D 90 desk



L/W	180	P/D	90	H/H	74	M	V
	200						

Modesty panel
Modesty panels



LP/TL	80	L/W	67	P/D	1.8	H/H	35
	100		87				
	120		107				
	140		127				
	160		147				
	180		167				
	200		187				

Allungo laterale P 65 - P 80
D 65 - D 80 desk return



L/W	80	P/D	65	H/H	74	M
	100		80			
	120					
	100		65		74	V

Allungo laterale per cassettera P 65
D 65 return for high pedestal



L/W	80	P/D	65	H/H	74
	100				
	120				

Scrivanie P 80 - P 90 integrabili con mobile di servizio
D 80 - D 90 desks to be connected to the service unit



L/W	160	P/D	80	H/H	74	M
	180					
	200					
	180		90		74	M
	200					

Bench - Accessori - Tavoli riunione
Benches - Accessories - Meeting tables

Bench P 136.5 - P 166.5
D 136.5 - D 166.5 benches

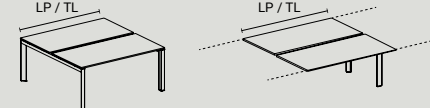

L/W	100	P/D	136.5	H/H	74
	120		166.5		
	140				
	160				
	180				
	200				

Bench integrabile con mobile di servizio P 166.5
D 166.5 bench to be connected to the service unit

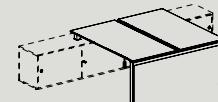

L/W	160	P/D	166.5	H/H	74
	180				
	200				

Bench P 158 - Piano unico con asole - 2 top access
D 158 bench - One-piece worktop with slots - 2 top access

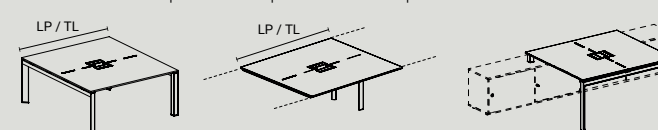

L/W	140	P/D	158	H/H	74
	160				
	180				

Bench P 158 - Con binario centrale - 2 sportelli
D 158 bench - With central rail - 2 flip doors

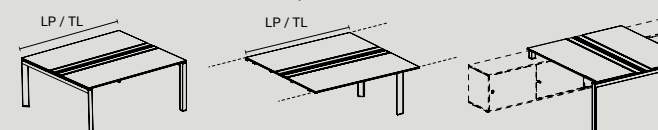

L/W	160	P/D	158	H/H	74
	180				
	200				

Binario centrale con staffe per bench P 136.5 - P 166.5
Central rail with brackets for D 136.5 - D 166.5 benches

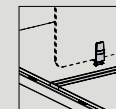

L/W	120	P/D	6.5	H/H	1.8
	140				
	160				
	180				
	200				

Piano terminale con supporti o colonne ^R
Lateral top with brackets or columns

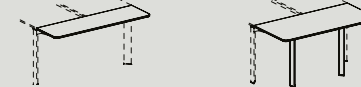

* con supporti with brackets
II con colonne with columns

L/W	136.5	P/D	40	H/H	1.8	*
	158					
	166.5					
	136.5		65		74	II
	158					
	166.5					

Tavolo riunioni rettangolare P 120
D 120 rectangular meeting table

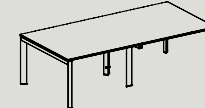

L/W	240	P/D	120	H/H	74
-----	-----	-----	-----	-----	----

Tavolo riunioni P 136.5
D 136.5 meeting tables

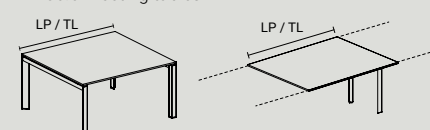

L/W	140	P/D	136.5	H/H	74
	160				
	180				

M Melaminico
Melamine

* Con Supporto
Con Supporto

R Piani con angoli raggiati R. 45 mm
Worktops with rounded corners R. 45 mm

Dimensioni espresse in centimetri
Dimensions stated in centimetres

V Vetro
Glass

II Con colonne
Con colonne



DV812 - ENNA
DV812 - ENNA



C DV812 - ENNA CON RUOTE NERE
DV812 - ENNA WITH BLACK CASTORS

Finiture Finishes

Scrivania Desk

M Piani scrivania sp. 38 mm
Worktops th. 38 mm



M Modesty panel sp. 18 mm
Modesty panel th. 18 mm

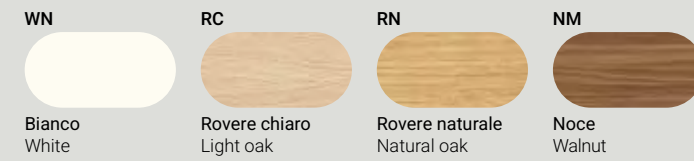

MT Gambe metalliche
Metal legs



LEGENDA LEGEND

M Melaminico
Melamine

C Con ruote
With castors

MT Metallo
Metal

* Non in pronta consegna
* Not in prompt delivery

Dati tecnici
Technical data

Scrivania
Desks

C	Scrivania P 65 - Scrivania da collegare in linea D 65 desk - In-line connectable desk	L/W 120	P/D 65	H/H 75.5
		140 160 180		

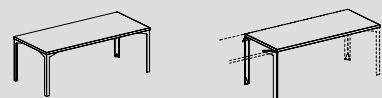

C	Scrivanie P 80 - P 90 - Scrivanie da collegare in linea D 80 - D 90 desk - In-line connectable desks	L/W 140	P/D 80	H/H 75.5
		160 180 200		
		180	P/D 90	H/H 75.5

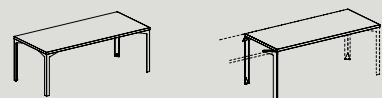

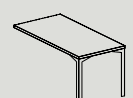
Scrivanie integrabili a contenitori Desks to be connected to the service unit/storage units		L/W 160	P/D 65	H/H 75.5
		180		
		160	P/D 80	H/H 75.5
		180 200	P/D 90	H/H 75.5

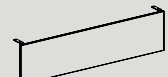
Modesty Panels Modesty Panels		LP/TL 120	L/W 87	P/D 1.8	H/H 35
		140	107		
		160	127		
		180	147		
		200	167		

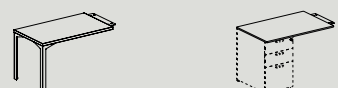
Allungo laterale P 65 D 65 desk return		L/W 120	P/D 65	H/H 75.5
				

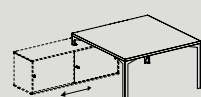
Tavolo P 140 per integrazione con mobile di servizio D 140 table to be connected to the service unit		L/W 140	P/D 140	H/H 75.5
				

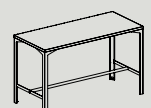
Tavolo alto H 107 H 107 high table		L/W 140	P/D 65	H/H 107
		160	80	
		180		

Bench - Accessori
Benches - Accessories

Bench P 136.5 - P 166.5 D 136.5 - D 166.5 benches	L/W 140	P/D 136.5	H/H 75.5
	160 180	166.5	

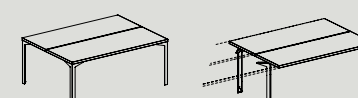

Bench P 136.5 - P 166.5 integrabile ai contenitori D 136.5 - D 166.5 benches to be connected to the storage units	L/W 160	P/D 136.5	H/H 75.5
	180	166.5	

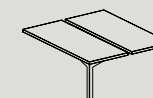

Bench P 136.5 - Piano unico con asole - 2 top access D 136.5 benches - One-piece worktop with slots - 2 top access	L/W 140	P/D 136.5	H/H 75.5
	160		

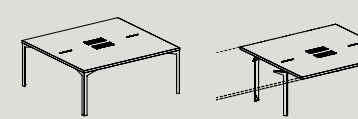

Bench P 136.5 - Piano unico con asole - 2 top access - Integrabile ai contenitori D 136.5 benches - One-piece worktop with slots - 2 top access - To be connected to the storage units	L/W 160	P/D 136.5	H/H 1.8

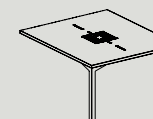

Binario centrale con staffe per bench P 136.5 - P 166.5 Central rail with brackets for D 136.5 - D 166.5 benches	L/W 140	P/D 6.5	H/H 1.8
	160 180		

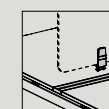

Dati tecnici
Technical data

Esempi di configurazioni
Configuration examples

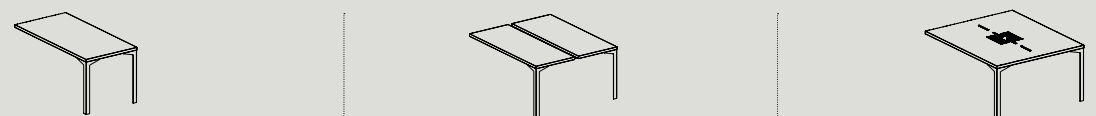

Fissaggio su mobile di servizio
Fixing to the service unit

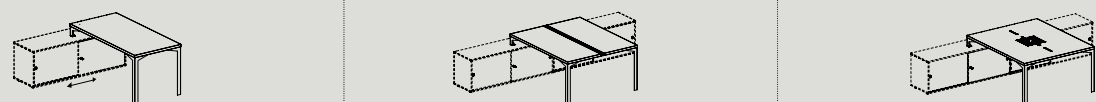

P/D 65 / 80 / 90 |

P/D 130 / 130.3 / 136.5
P/D 160 / 160.3 / 166.5 |

P/D 136.5 |

Fissaggio su contenitori DV505 - Orgatower
Fixing to the DV505 - Orgatower

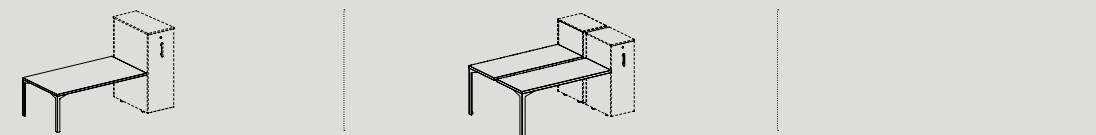

P/D 80 |

P/D 160 / 160.3 / 166.5 |

Fissaggio su modulo base DV504 - Milo
Fixing to the DV504 - Milo unit

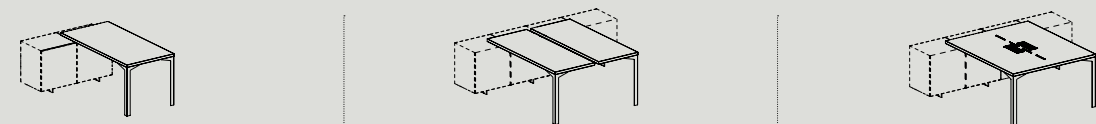

P/D 65 / 80 / 90 |

P/D 130 / 130.3 / 136.5
P/D 160 / 160.3 / 166.5 |

P/D 136.5 |

Fissaggio su contenitori DV505 - Rio
Fixing to the DV505 - Rio storage unit

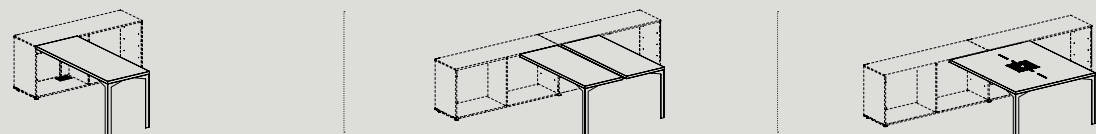

P/D 65 / 80 |

P/D 130 / 130.3 / 136.5
P/D 160 / 160.3 / 166.5 |

P/D 136.5 |

Fissaggio su contenitori multifunzione DV910 - Oxford H. 190
Fixing to the DV910 - Oxford multi-purpose storage unit H. 190

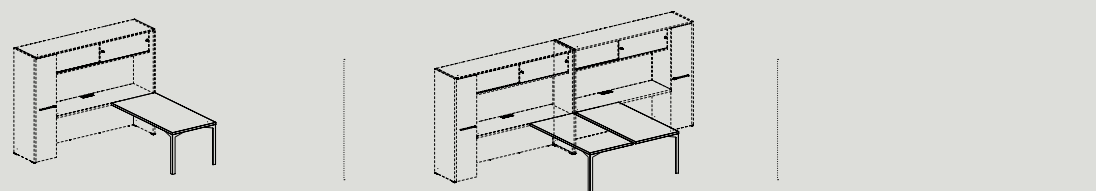

P/D 80 / 90 |

P/D 160 / 160.3 / 166.5 |

Tavoli riunione
Meeting tables

C Tavolo riunioni quadrato P 140
D 140 squared meeting table

L/W 140 | P/D 140 | H/H 75.5 |

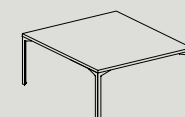

Tavolo riunione rettangolare P 120
D 120 rectangular meeting table

L/W 240 | P/D 120 | H/H 75.5 |

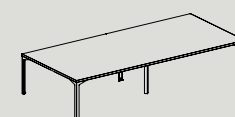

Tavolo riunioni ovale P 125 con 4 gambe freestanding
D 125 oval meeting table with 4 freestanding legs

L/W 250 | P/D 125 | H/H 75.5 |

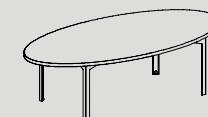

Tavoli riunione ovali P 125
D 125 oval meeting tables

L/W 250 | P/D 125 | H/H 75.5 |

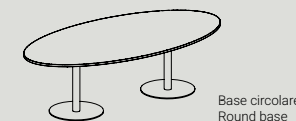

Base circolare
Round base

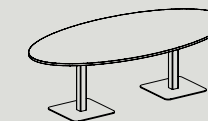

Base quadrata
Squared base

Tavoli riunione circolari Ø 100 - 120
Ø 100 - 120 round meeting tables

L/W 100 | P/D 100 | H/H 75.5 |
120 | 120 |



Base circolare
Round base



Base quadrata
Squared base



DV802 - PAG W



DV802 - PAG A



DV802 - PAG U



RG DV802 - U Reg./Adj.



DV802 - PAG O

Finiture Finishes

Scrivania Desk

M Piani scrivania e modesty panel sp. 18 mm
Worktops and modesty panel th. 18 mm

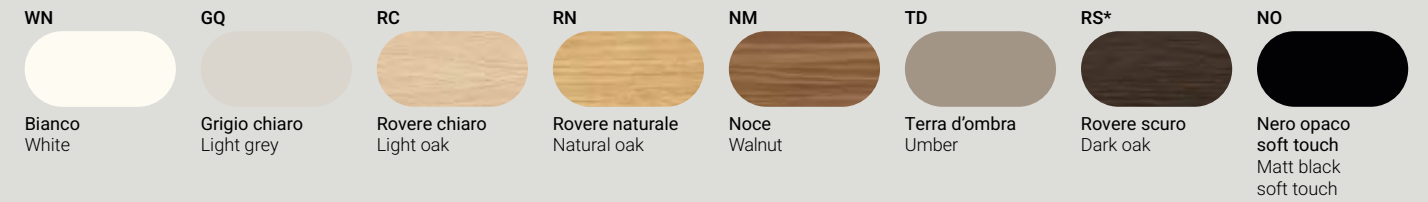

M Solo per modesty panel sp. 18 mm
Only for modesty panel th. 18 mm



V Piani scrivania sp.10 mm in vetro temprato retrolaccato acidato
Worktops th.10 mm in rear-lacquered acetated tempered glass

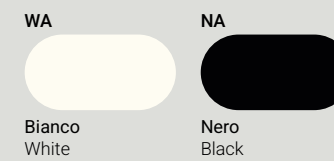

MT Gambe metalliche per scrivanie
Metal legs for desks



MT **W** Gambe in massello impiallacciato e metallo
Legs in solid wood veneer and metal

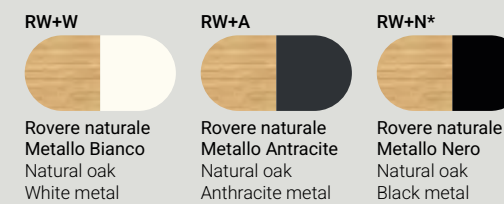

MT Travi in metallo
Metal beams



LEGENDA LEGEND

M Melaminico
Melamine

V Vetro
Glass

RG Gamba regolabile
Adjustable leg

* Non in pronta consegna
* Not in prompt delivery







W Legno
Wood

MT Metallo
Metal

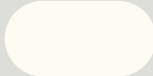
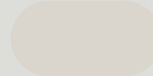

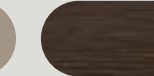

Finiture
Finishes

Social Table* - Media Table* - High Table*
Social Table* - Media Table* - High Table*

M Piani scrivania sp. 18 mm
Worktops th. 18 mm

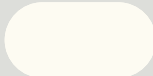
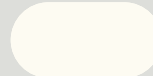
WN  Bianco White	GQ  Grigio chiaro Light grey	RC  Rovere chiaro Light oak	RN  Rovere naturale Natural oak	NM  Noce Walnut	TD  Terra d'ombra Umber	RS  Rovere scuro Dark oak	NO  Nero opaco soft touch Matt black soft touch
---	---	--	--	--	--	--	--

Struttura metallica su ruote con freno
Metal structure on castors with brake

W  MT Bianco White	W  P Bianco (ruote) White (castors)	A  MT Antracite Anthracite	N  P Nero (ruote) Black (castors)	N  MT Nero Black	N  P Nero (ruote) Black (castors)
--	---	--	---	--	---



SOCIAL TABLE



MEDIA TABLE



HIGH TABLE

LEGENDA
LEGEND

M Melaminico
Melamine







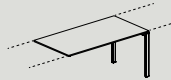

P ABS/Plastica
Plastic/ABS

MT Metallo
Metal

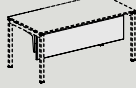
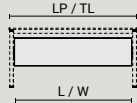





* Non in pronta consegna
* Not in prompt delivery

Dati tecnici
Technical data

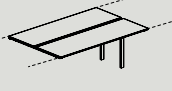
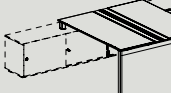
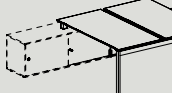
Scrivania
Desks

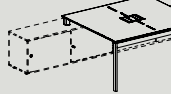
RG	Scrivanie P 65 - P 80 D 65 - D 80 desks		L/W 80	P/D 65	H/H 74	
			100 120 140 160 180 200	80		
RG	Scrivanie da collegare in linea P 65 - P 80 (solo per gambe U/O) D 65 - D 80 in-line connectable desks (only for legs U/O)		L/W 80	P/D 65	H/H 74	
			100 120 140 160 180 200	80		
RG	Scrivanie P 90 D 90 desks	 	L/W 180	P/D 65	H/H 74	M
			200	80		
			180	90	74	V
			200			
RG	Modesty panel Modesty panels	 	LP/TL 80	L/W 67	P/D 1.8	H/H 35
			100 120 140 160 180 200	87 107 127 147 167 187		
RG	Allungo laterale P 65 - P 80 D 65 - D 80 desk return	  	L/W 80	P/D 65	H/H 74	M
			100 120	80		
			100	65	74	V
	Allungo laterale per cassettiere P 65 Desk return for high pedestals D 65		L/W 80	P/D 65	H/H 74	
			100 120	80		
	Scrivanie P 80 - P 90 integrabili con mobile di servizio D 80 - D 90 desks to be connected to the service unit	 	L/W 160	P/D 80	H/H 74	M
			180 200	80 90	74	M
			180	90	74	V
			200			

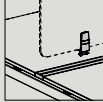
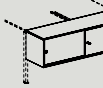
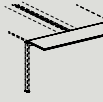
Bench - Accessori
Benches - Accessories

RG	Bench P 136.5 - P 166.5 D 136.5 - D 166.5 benches	 	L/W 100	P/D 136.5	H/H 74	
			120 140 160 180 200	166.5		
	Bench P 158 - P 166.5 integrabili con mobile di servizio D 158 - D 166.5 bench to be connected to the service unit	 	L/W 160	P/D 158	H/H 74	
			180 200			
	P/D 158	P/D 166.5				
RG	Bench P 158 - Piano unico con asole - 2 top access D 158 bench - One-piece worktop with slots - 2 top access	  	L/W 140	P/D 158	H/H 74	
			160 180			
RG	Bench P 158 - Con binario centrale - 2 sportelli D 158 bench - With central rail - 2 flip doors	 	L/W 120	P/D 158	H/H 74	
			140 160 180 200			
	Binario centrale con staffe per bench P 136.5 - P 166.5 Central rail with brackets for D 136.5 - D 166.5 benches		L/W 120	P/D 6.5	H/H 1.8	
			140 160 180 200			
	Contenitore terminale P 136.5 - 158 - 166.5 (solo per gambe U/O) D 136.5 - 158 - 166.5 storage unit (only for legs U/O)		L/W 136.5	P/D 40	H/H 40	
			158 166.5			
*	Piano terminale con supporti o colonne Lateral top with brackets or columns	 	L/W 136.5	P/D 40	H/H 1.8	*
			158 166.5			
II	con supporto with brackets	II	con colonne with columns	65	74	II
			136.5 158 166.5			

M Melaminico
Melamine

* Con Supporto
Con Supporto

RG Gamba regolabile
Adjustable leg

V Vetro
Glass

II Con colonne
Con colonne

R Piani con angoli raggati R. 45 mm
Worktops with rounded corners R. 45 mm

Dimensioni espresse in centimetri
Dimensions stated in centimetres

Dati tecnici
Technical data

Tavoli riunione
Meeting tables

Tavolo riunioni rettangolare P 120
D 120 rectangular meeting table

L/W 240 | P/D 120 | H/H 74 |

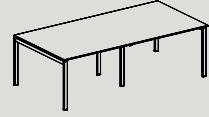

Tavolo riunioni P 136.5
D 136.5 meeting tables

L/W 140
160
180 | P/D 136.5 | H/H 74 |

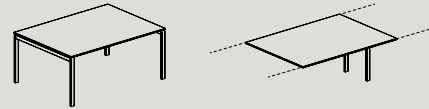

Tavoli riunione circolari - Ø100 - 120 (gambe A/W)
Ø100 - 120 round meeting tables (A/W legs)

L/W 100
120 | P/D 100
120 | H/H 74 |



Tavoli su ruote - Accessori
Tables on castors - Accessories

Social table su ruote con freno
Social table on castors with brake

L/W 210.4 | P/D 90 | H/H 200 |



Media table su ruote con freno
Media table on castors with brake

L/W 210.4 | P/D 90 | H/H 200 |



High table su ruote con freno
High table on castors with brake

L/W 210.4 | P/D 90 | H/H 107 |



Contenitore metallico per traverso superiore
Metal box for upper beam

L/W 50 | P/D 25 | H/H 20 |

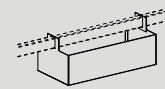

Gancio per traversi
Hook for bag

L/W 8 | P/D 6.5 | H/H 9 |

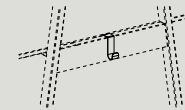

Contenitore metallico porta oggetti
Metal box for objects

L/W 25 | P/D 11 | H/H 20 |

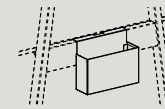

Staffa porta Monitor
Monitor stand bracket

L/W 44 | P/D 6.5 | H/H 53 |

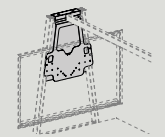



DV803 - NOBU
DV803 - NOBU



DV803 - NOBU CON PULSANTE
DV803 - NOBU WITH PUSH-BUTTON



DV803 - NOBU A MANOVELLA
DV803 - NOBU WITH CRANK



DV803 - NOBU RIBALTABILE
DV803 - NOBU FOLDING TABLE

Finiture Finishes

Scrivania Desk

M Piani scrivania sp. 25 mm e modesty panel sp. 18 mm
Worktops th. 25 mm and modesty panel th. 18 mm

WN

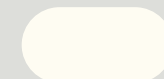

Bianco
White

GQ

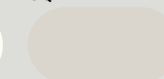

Grigio chiaro
Light grey

RC



Rovere chiaro
Light oak

RN



Rovere naturale
Natural oak

NM



Noce
Walnut

TD



Terra d'ombra
Umber

NO



Nero opaco
soft touch
Matt black
soft touch

M Solo per modesty panel sp. 18 mm
Only for modesty panel th. 18 mm

HH



Alluminio
Aluminium

MT Gambe metalliche
Metal legs

W

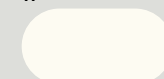

Bianco
White

H



Alluminio
Aluminium

A



Antracite
Anthracite

RO*



Rosso mattone
Brick red

VS*



Verde salvia
Sage green

AP*



Azzurro polvere
Powder blue

N*



Nero
Black

MT Trave telescopica in metallo
Telescopic metal beam

H



Alluminio
Aluminium

T Modesty panels per tavolo ribaltabile
Modesty panel for folding table

N



Nero
Black

LEGENDA LEGEND

M Melaminico
Melamine

MT Metallo
Metal

T Tessuto
Fabric

* Non in pronta consegna
* Not in prompt delivery

Dati tecnici
Technical data

Scrivania
Desks

Scrivania P 65 - Scrivania da collegare in linea
D 65 desks - In-line connectable desk



L/W	80	P/D	65	H/H	74
	100				
	120				
	140				
	160				
	180				

Scrivania P 80 - Scrivania da collegare in linea
D 80 desks - In-line connectable desk



L/W	80	P/D	80	H/H	74
	100				
	120				
	140				
	160				
	180				
	200				

Scrivania P 100
D 100 desk

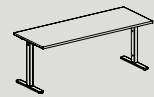

L/W	200	P/D	100	H/H	74
-----	-----	-----	-----	-----	----

Modesty panel
Modesty panels



L.P./TL	80	L/W	67	P/D	1.8	H/H	35
	100		87				
	120		107				
	140		127				
	160		147				
	180		167				

Allungo laterale P 65 per scrivanie P 65 - P 80
D 65 desk return for desks D 65 - D 80

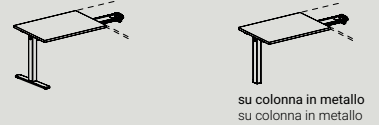

L/W	80	P/D	65	H/H	74
	100				
	120				

Allungo laterale per cassettiere P 65
Desk return for high pedestals D 65

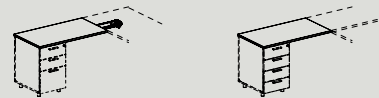

L/W	100	P/D	65	H/H	74
-----	-----	-----	----	-----	----

Scrivanie P 65 - P 80 integrabili con mobile di servizio
D 65 - D 80 desks to be connected to the service unit

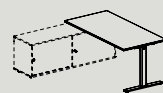

L/W	140	P/D	65	H/H	74
	160		80		
	180				

Raccordi - Terminali
Connections - Terminal

Raccordo 2 vie curvo a 90°
90° 2-way curved connection



L/W	80	P/D	80	H/H	2.5
-----	----	-----	----	-----	-----

Raccordo 2 vie curvo a 90° - Dx e Sx
R and L - 90° 2-way curved connection



L/W	65	P/D	80	H/H	2.5
-----	----	-----	----	-----	-----

Terminale 180°
180° terminal top

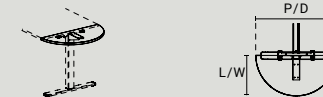

L/W	40	P/D	80	H/H	2.5
-----	----	-----	----	-----	-----

Raccordo 2 vie curvo a 90° su colonna
90° 2-way curved connection with metal column



L/W	80	P/D	80	H/H	74
-----	----	-----	----	-----	----

Terminale 180° su colonna
180° terminal with metal column



L/W	50	P/D	100	H/H	74
-----	----	-----	-----	-----	----

Dati tecnici
Technical data

Scrivania
Desks

Scrivania P 65 - P 80 - altezza regolabile a pulsante
D 65 - D 80 height adjustable desk with push-button

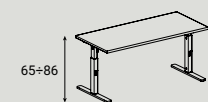

65+86

L/W	80	P/D	65	H/H	65+86
	100		80		
	120				
	140				
	160				
	180				

Scrivania P 100 - altezza regolabile a pulsante
D 100 height adjustable desk with push-button

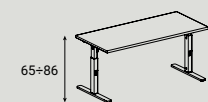

65+86

L/W	200	P/D	100	H/H	65+86
-----	-----	-----	-----	-----	-------

Allungo P 65 per scrivanie - altezza regolabile a pulsante P 65 - P 80
D 65 height adjustable return with push-button for D 65 - D 80 desks

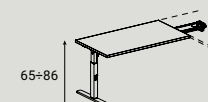

65+86

L/W	80	P/D	65	H/H	65+86
	100				
	120				

Scrivania P 65 - P 80 - altezza regolabile a manovella
D65 - D 80 height adjustable desk with crank



74+112

L/W	140	P/D	65	H/H	74+112
	160		80		
	180				

Allungo per scrivanie P 65 - P 80 - altezza regolabile a manovella
Height adjustable return with crank for D 65 - D 80 desks

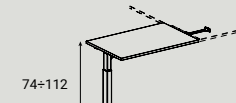

74+112

L/W	80	P/D	65	H/H	74+112
	100				

Scrivania
Desk

Tavoli ribaltabili P 70 - P 80
D 70 - D 80 Folding tables

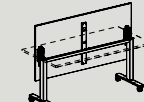

L/W	80	P/D	70	H/H	74
	100		80		
	120				
	140				
	160				
	180				

Modesty panel in tessuto
Fabric modesty panels

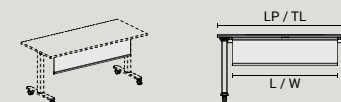

L.P./T.L.	80	L/W	46.5	P/D	1	H/H	31
	100		66.5				
	120		86.5				
	140		106.5				
	160		126.5				
	180		146.5				

Coppia ganci per unione tavoli ribaltabili
Hooks kit for desk with flip worktops



Tavoli riunione
Meeting tables

Tavoli riunione rettangolari P 100 - P 120
D 100 - D 120 rectangular meeting tables

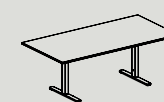

L/W	200	P/D	100	H/H	74
	240	P/D	120	H/H	74

Tavolo riunione P 120
D 120 meeting table

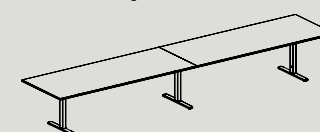

L/W	480	P/D	120	H/H	74
-----	-----	-----	-----	-----	----

Tavolo riunioni ovale P 125
D 125 oval meeting table



L/W	250	P/D	125	H/H	74
-----	-----	-----	-----	-----	----



DV818 - TOLEDO

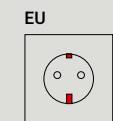

Preso per mercato EU
EU power outlet



Preso per mercato UK
UK power outlet

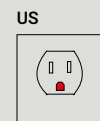

Preso per mercato US
US power outlet

LEGENDA
LEGEND

M Melaminico
Melamine

T Tessuto
Fabric

MT Metallo
Metal

P Plastica
Plastic

* Non in pronta consegna
* Not in prompt delivery

Finiture
Finishes

Scrivania
Desk

M Piani scrivania sp. 25 mm e modesty panel sp. 18 mm
Worktops th. 25 mm and modesty panel th. 18 mm

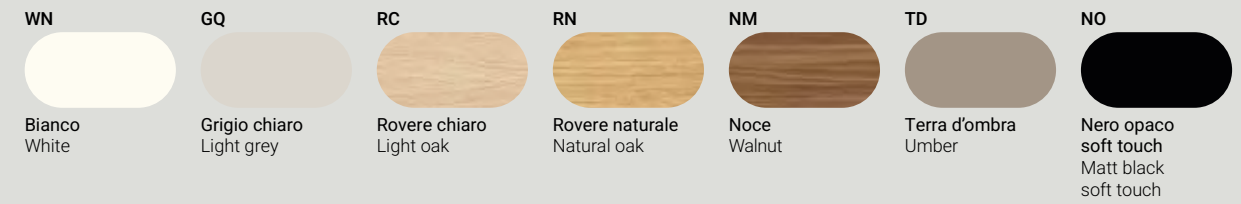

MT Gambe metalliche
Metal legs

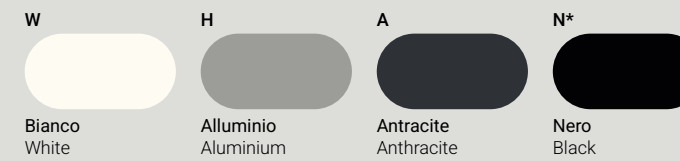

MT Trave telescopica in metallo
Telescopic metal beam



Frontal Panels
Frontal panels

T Frontal panel acustico in fibra di poliestere rivestito con tessuto (standard) - Trevira CS Bioactive
Acoustic polyester fibre screen covered with fabric (standard) - Trevira CS Bioactive



T Tessuto Trevira CS Bioactive *
Fabric Trevira CS Bioactive *



P Morsetti in nylon
Nylon clamps



Dati tecnici
Technical data

Scrivania
Desks

Scrivania P 65 - 80
D 65 - D 80 desk

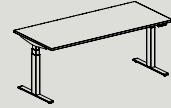

L/W	120	P/D	65	H/H	64.5÷130
	140		80		
	160				
	180				

Scrivania P 65 con allungo P 65
D 65 desk with D 65 desk return

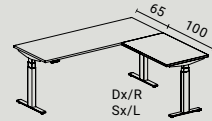

L/W	140	P/D	165	H/H	64.5÷130
	160				
	180				

Scrivania P 80 con allungo P 65
D 80 desk with D 65 desk return

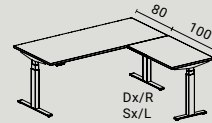

L/W	140	P/D	180	H/H	64.5÷130
	160				
	180				

Bench - Frontal panel
Benches - Screens

Bench P 136.5 - P 166.5
D 136.5 - D 166.5 benches

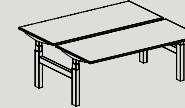

L/W	120	P/D	136.5	H/H	61.5÷127.5
	140		166.5		
	160				
	180				

Bench P 136.5 con allungo L 100
D 136.5 bench with W 100 desk return

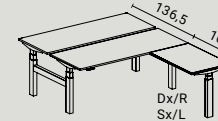

L/W	140	P/D	236.5	H/H	61.5÷127.5
	160				
	180				

Bench P 166.5 con allungo L 100
D 166.5 bench with W 100 desk return

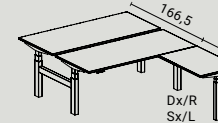

L/W	140	P/D	266.5	H/H	74
	160				
	180				

Bench P 136.5 con 2 allungo L 100
D 136.5 bench with W 100 desk return

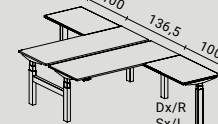

L/W	140	P/D	336.5	H/H	74
	160				
	180				

Bench P 166.5 con 2 allungo L 100
D 166.5 bench with W 100 desk return

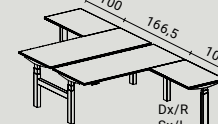

L/W	140	P/D	366.5	H/H	74
	160				
	180				

Frontal panel per scrivanie
Screen for desks



L/W	64	P/D	3	H/H	39
	79				
	99				
	119				
	139				
	159				
	179				

Frontal panel per bench
Screen for benches

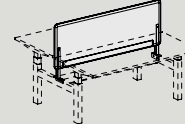

L/W	139	P/D	3	H/H	70
	159				

Frontal panel per bench (non acustico)
Screen for benches (not acoustic)

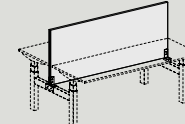

L/W	140	P/D	3	H/H	70
	160				
	180				



DV805 - TREKO

Finiture Finishes

Scrivania Desk

M Piani scrivania sp. 25 mm
Worktops th. 25 mm

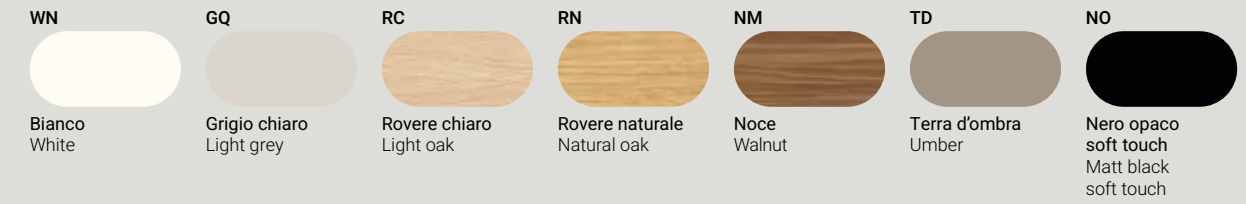

M Gambe pannellate sp. 25 mm - Modesty panel sp. 18 mm. Melaminico con bordo in ABS bianco
Panelled legs th. 25 mm - Modesty panels th. 18 mm. Melamine with white ABS edge banding

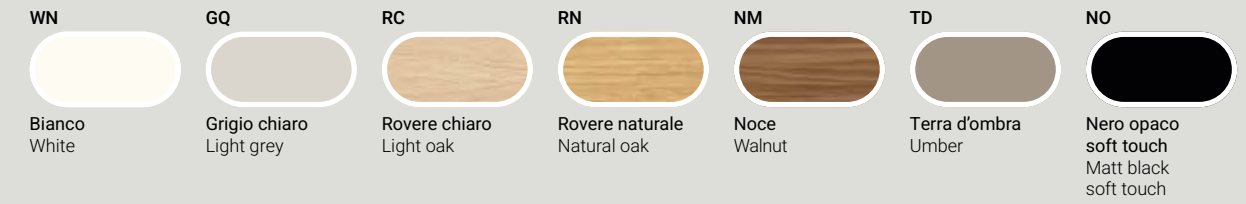

P Kit distanziali e piedini in ABS
Kit of ABS spacers and feet

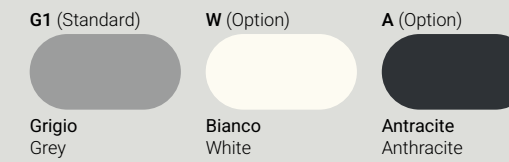

LEGENDA LEGEND

M Melaminico
Melamine

P Plastica
Plastic

* Non in pronta consegna
* Not in prompt delivery

Dati tecnici
Technical data

Scrivania
Desks

Scrivania P 65 P 80 - Scrivania da collegare in linea
D 65 D 80 desks - In-line connectable desk



L/W	80	P/D	65	H/H	74
	100		80		
	120				
	140				
	160				
	180				
	200				

Scrivania P 100
D 100 desk

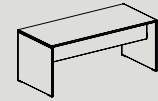

L/W	200	P/D	100	H/H	74
-----	-----	-----	-----	-----	----

Allungo P 65
D 65 return

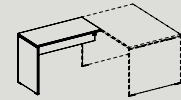

L/W	80	P/D	65	H/H	74
	100				

Allungo con cassetiera portante - 3/4 cassetti
Return with high pedestal - 3/4 drawers

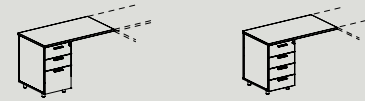

L/W	100	P/D	65	H/H	74
	120				

Tavolo alto H 107
High table H 107

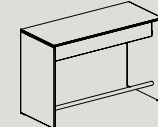

L/W	140	P/D	80	H/H	107
	160				
	180				

Raccordi - Terminali
Connections - Terminal

Raccordo 2 vie curvo a 90°
90° 2-way curved connection



* con supporto
with brackets

II con colonne
with column

L/W	80	P/D	80	H/H	2.5
	80		80		74

Raccordo 2 vie curvo a 90° - Dx e Sx
R and L - 90° 2-way curved connection

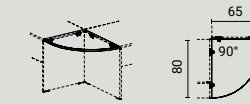

L/W	65	P/D	80	H/H	2.5
-----	----	-----	----	-----	-----

Terminale 180°
180° terminal top

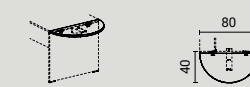

L/W	40	P/D	80	H/H	2.5
-----	----	-----	----	-----	-----

Tavoli riunione
Meeting tables

Tavoli riunione rettangolari P 100 - P 120
D 100 - D 120 rectangular meeting tables

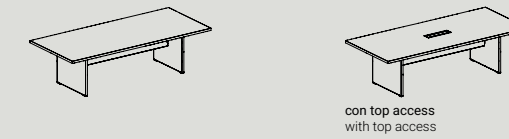

L/W	200	P/D	100	H/H	74
	240		120		

Tavoli riunione ovali P 125
D 125 oval meeting tables

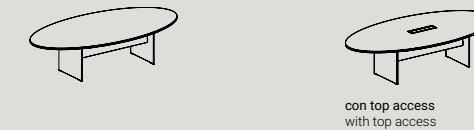

L/W	250	P/D	125	H/H	74
-----	-----	-----	-----	-----	----



DV817 - OSLO



Montaggio veloce con solo 4 viti
Trave ad innesto rapido
Quick assembly with only 4 screws
Quick-connect beam

Finiture Finishes

Scrivania Desk

M Piani scrivania sp. 25 mm e modesty panel sp. 18 mm
Worktops th. 25 mm and modesty panel th. 18 mm



MT Gambe metalliche
Metal legs



P Particolari in ABS
Kit of ABS spacers and round feet

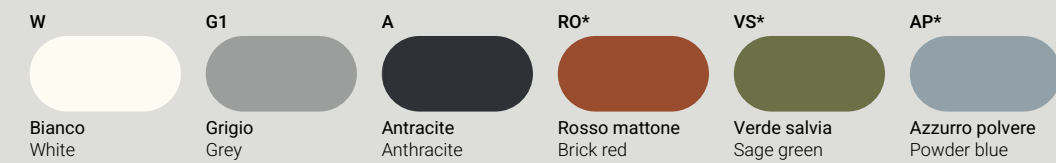

MT Trave in metallo
Metal beam

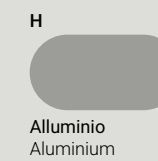

LEGENDA LEGEND

M Melaminico
Melamine

P Plastica
Plastic

MT Metallo
Metal

* Non in pronta consegna
* Not in prompt delivery

Dati tecnici
Technical data

Scrivania
Desks

Scrivania P 55 - P 80
D 55 - D 80 desks

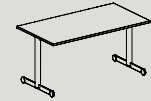

L/W	80 100	P/D	55	H/H	74
L/W	120 140 160 180	P/D	80	H/H	74

Scrivania P 80 da collegare in linea
D 80 desks - In-line connectable desks

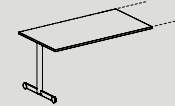

L/W	120 140 160 180	P/D	80	H/H	74
-----	--------------------------	-----	----	-----	----

Modesty panel
Modesty panels

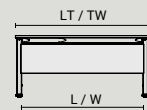
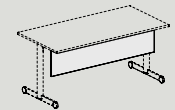

L/W	120 140 160 180	L/W	107 127 147 167	P/D	1.8	H/H	35
-----	--------------------------	-----	--------------------------	-----	-----	-----	----

Allungo laterale P 55
D 55 desk return

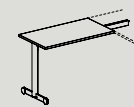

L/W	80 100	P/D	55	H/H	74
-----	-----------	-----	----	-----	----

Allungo laterale per cassetteria P 65
Desk return for high pedestal D 65

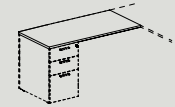

L/W	100	P/D	65	H/H	74
-----	-----	-----	----	-----	----

Scrivania P 80 integrabile con mobile di servizio
D 80 desks to be connected to the service unit

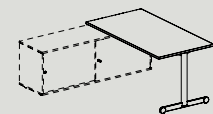

L/W	140 160 180	P/D	80	H/H	74
-----	-------------------	-----	----	-----	----

Tavolo alto H 107
High table H 107

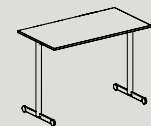

L/W	140 160 180	P/D	80	H/H	107
-----	-------------------	-----	----	-----	-----

Bench - Tavoli riunione
Benches - Meeting tables

Bench P 166.5
D 166.5 benches

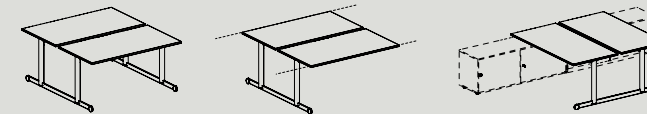

L/W	140 160 180	P/D	166.5	H/H	74
-----	-------------------	-----	-------	-----	----

Scrivanie e bench integrabili ai contenitori DV505 - Rio: H. 74 - 115 - 164.5
Desks and benches to be connected to the DV505 - Rio storage units: H. 74 - 115 - 164.5

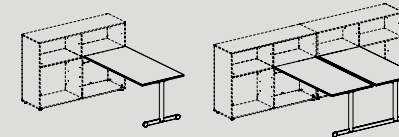

L/W	140 160 180	P/D	80 166.5	H/H	74
-----	-------------------	-----	-------------	-----	----

Scrivanie e bench integrabili con DV505 - Orgatower P 80 - H 74 - 115
Desks and benches to be connected to the DV505 - Orgatower D 80 - H 74 - 115

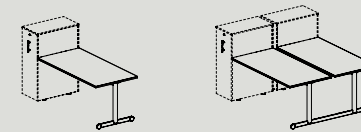

L/W	140 160 180	P/D	80 166.5	H/H	74
-----	-------------------	-----	-------------	-----	----

Tavoli riunione rettangolari P 100 - P 120
D 100 - D 120 rectangular meeting tables

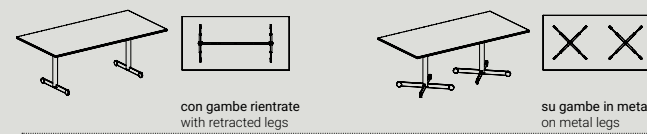

L/W	200 240	P/D	100 120	H/H	74
-----	------------	-----	------------	-----	----

Tavoli riunione ovali P 125
D 125 oval meeting tables



L/W	200	P/D	125	H/H	74
-----	-----	-----	-----	-----	----

Tavoli riunione circolari Ø 100 - 120
Ø 100 - 120 round meeting tables



L/W	100 120	P/D	100 120	H/H	74
-----	------------	-----	------------	-----	----

Tavoli caffè Ø 80 - H 45 - 107
Ø 80 - H 45 - 107 coffee tables

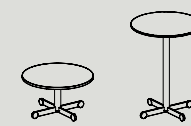

L/W	80	P/D	80	H/H	45 107
-----	----	-----	----	-----	-----------



DV816 - NIDA

Finiture Finishes

Scrivania Desk

M Piani scrivania sp. 25 mm
Worktops th. 25 mm

WN*

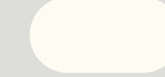

Bianco
White

NO*



Nero opaco
soft touch
Matt black
soft touch

MT Gambe e schermi in metallo
Metal legs and metal screens

W*

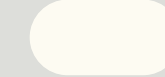

Bianco
White

A*



Antracite
Anthracite

AP*



Azzurro polvere
Powder blue

P Cordoncino elastico
Elastic cord

R



Rosso
Red

Dati tecnici Technical data

Scrivania Desk

Scrivania con gambe freestanding
Desk with freestanding legs

L/W 140 | P/D 65 | H/H 76 |



Scrivania con schermi metallici
Desk with metal screen

L/W 140 | P/D 65 | H/H 96 |

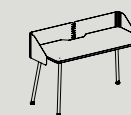

LEGENDA LEGEND

M Melaminico
Melamine

P Plastica
Plastic

MT Metallo
Metal

* Non in pronta consegna
* Not in prompt delivery



DV990 - MEET



DV990 - Tavoli riunione regolabili
con sistema pneumatico a pedale
DV990 - Adjustable meeting tables
with pneumatic pedals system

Finiture Finishes

Tavoli riunione universali Universal meeting tables

M Piani sp. 25 mm
Worktops th. 25 mm

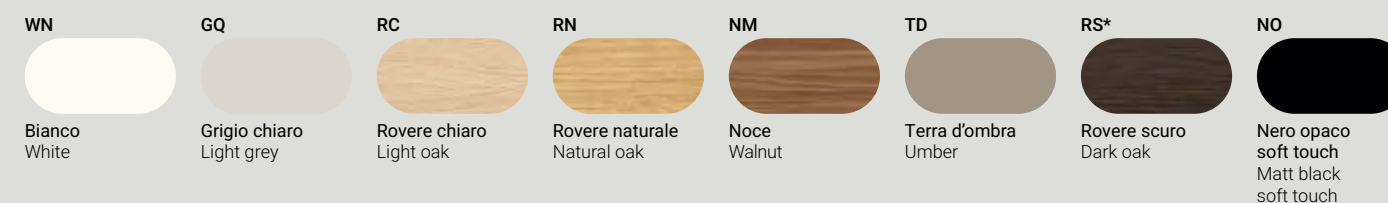

MT Gambe metalliche
Metal legs

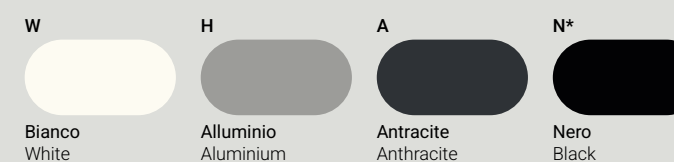

Tavoli riunione regolabili con sistema pneumatico a pedale Adjustable meeting tables with pneumatic pedals system

M Piani sp. 18 mm
Worktops th. 18 mm

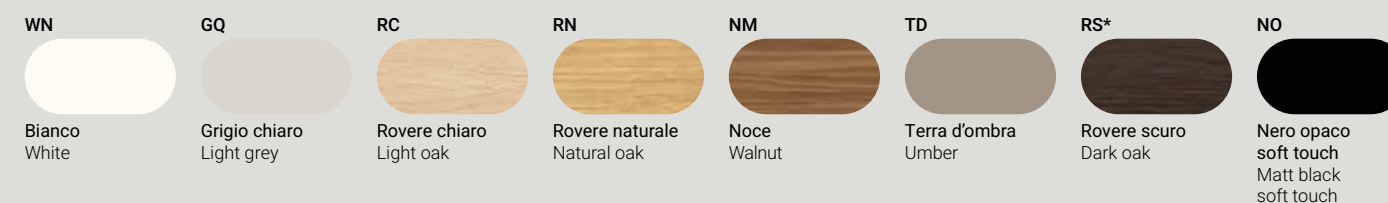

MT Struttura metallica
Metal structure

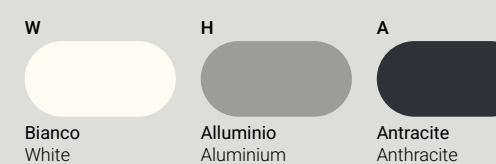

LEGENDA LEGEND

M Melaminico
Melamine
MT Metallo
Metal

* Non in pronta consegna
* Not in prompt delivery

Dati tecnici
Technical data

Tavoli riunione universali
Universal meeting tables

Tavoli riunione circolari Ø 100 - 120
Ø 100 - 120 round meeting tables

L/W 100 | P/D 100 | H/H 74 |
120

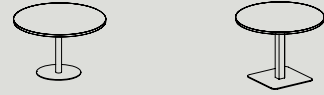

Tavoli riunione rettangolari L 200 - P 100
W 200 - D 100 rectangular meeting tables

L/W 200 | P/D 100 | H/H 74 |

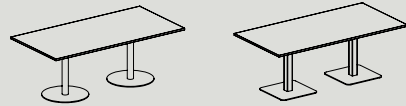

Tavoli riunione rettangolari L 240 - P 120
W 240 - D 120 rectangular meeting tables

L/W 240 | P/D 120 | H/H 74 |

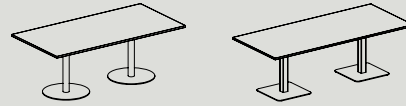

Tavoli riunione ovali L 250 - P 125
W 250 - D 125 oval meeting tables

L/W 250 | P/D 125 | H/H 74 |



Tavoli riunione regolabili con sistema pneumatico a pedale
Adjustable meeting tables with pneumatic pedals system

Tavolo riunione circolare Ø 80
Ø 80 round meeting table

L/W 80 | P/D 80 | H/H 71÷115 |



Tavolo riunione quadrato L 80
W 80 square meeting table

L/W 80 | P/D 80 | H/H 71÷115 |





OFFICE POD



PARETINE
OFFICE CUBICLE



MODULI SEDUTA COMPONENTI
MODULAR SEATING BLOCKS

Finiture Finishes

Paretine* - Office Pod* - Moduli seduta componibili* Office Cubicle* - Office Pod* - Modular seating blocks*

M Pannelli sp. 25 mm con bordo in ABS bianco
Panels th. 25 mm with white ABS edge banding

MTR



Trama "Grigio"
"Grey" fabric texture

MT Montanti in metallo per paretine
Metal uprights for Office Cubicle

W

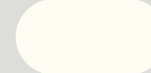

Bianco
White

M Piani scrivania sp. 25 mm
Worktops th. 25 mm

WN

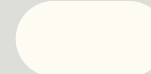

Bianco
White

GQ

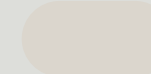

Grigio chiaro
Light grey

RC



Rovere chiaro
Light oak

RN



Rovere naturale
Natural oak

NM



Noce
Walnut

TD



Terra d'ombra
Umber

NO



Nero opaco
soft touch
Matt black
soft touch

T Pannelli sp. 1 mm
Panels th. 1 mm

FLT



Feltro "Grigio scuro"
"Dark grey" felt

LEGENDA
LEGEND

M Melaminico
Melamine

T Tessuto
Fabric

MT Metallo
Metal

* Non in pronta consegna
* Not in prompt delivery

Dati tecnici
Technical data

Parettine: Schiene - Fianchi
Partitions: Back panels - Sides

Pannelli verticali
Vertical panels



L/W	65	P/D 2.5	H/H 114
	80		
	100		
	140		
	160		
L/W	65	P/D 2.5	H/H 147
	80		
	100		
	140		
	160		
	180		

Copertura terminale
Terminal cover element



L/W	114	P/D 1.5	H/H 2.5
	147		
	180		

Montante per angoli 2-3-4 vie - Ø 5.5
Upright for 2-3-4 way corners - Ø 5.5

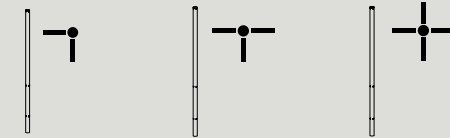

Ø	5.5	H/H 114	
			147
			180

Piani P 80
D 80 worktops

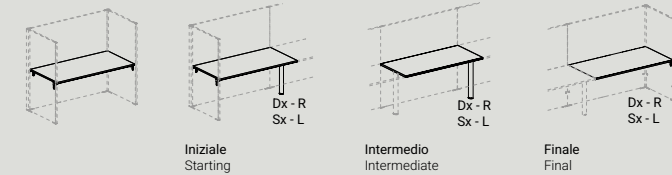

L/W	140	P/D 80	H/H 74
	160		
	180		

Allunghi P 65 - P 80
D 65 - D 80 desk return

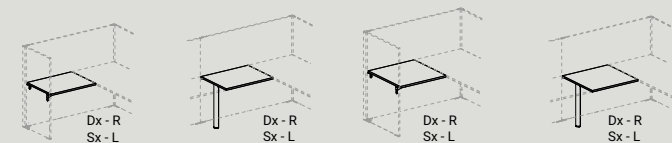

L/W	80	P/D 65	H/H 74
	100		

Accessori
Accessories

Pensile
Over-head unit

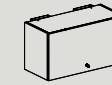

L/W	78	P/D 35	H/H 42

Lavagna
Whiteboard



L/W	80	P/D 1.8	H/H 80

Mensole
Shelfs

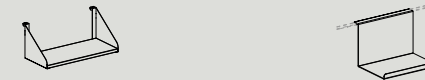

A	L/W 68	P/D 30	H/H 28
B	L/W 30		

Pomoli appendiabiti
Clothes hanger knobs

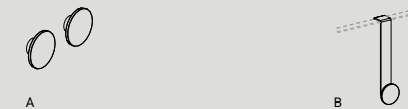

A	Ø 5	Ø 5	H/H 2
B	Ø 5		

Pannelli in feltro
Felt panels

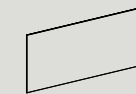

L/W	140	P/D 1	H/H 67.5
	160		
	180		

Barra porta accessori
Accessory bar



L/W	80	P/D 3	H/H 5
	120		
	140		
	160		

Box alimentazione
Power box

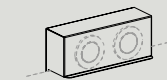

Prese elettriche Ø 7
Electrical outlets Ø 7



L/W	23	P/D 8	H/H 13

Dati tecnici
Technical data

Office pod
Office pod

Office pod
Office pod

L/W	165	P/D	100 140	H/H	220
-----	-----	-----	------------	-----	-----

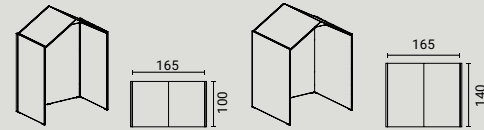

Office pod meeting
Office pod meeting

L/W	165	P/D	140	H/H	220
-----	-----	-----	-----	-----	-----

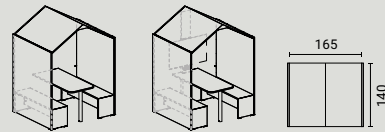

Staffe per monitor - Carter verticale passaggio cavi inclusi
Monitor brackets - Wire management box included

Office pod couch
Office pod couch

L/W	165	P/D	100	H/H	220
-----	-----	-----	-----	-----	-----

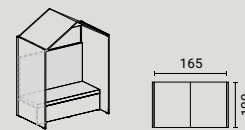

Office pod con piano scrivania
Office pod with worktop

L/W	165	P/D	100 140	H/H	220
-----	-----	-----	------------	-----	-----

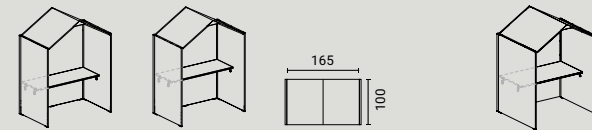

Piano H 74
Worktop H 74

Piano H 107
Worktop H 107

Piano H 74
Worktop H 74

Accessori
Accessories

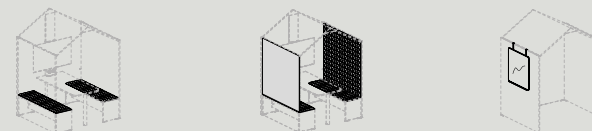

A
Cuscini seduta
Seat cushions

B
Cuscini seduta e schienale
Seat and back cushions

C
Lavagna per office pod
Whiteboard for office pod

A	L/W	137	P/D	39	H/H	3
B	L/W	137	P/D	3	H/H	127
C	L/W	80	P/D	1.8	H/H	80

Moduli pedane
Platform modules

Moduli P 45
D 45 modules

L/W	45 90 135	P/D	45	H/H	45
-----	-----------------	-----	----	-----	----

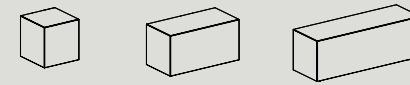

Moduli P 90
D 90 modules

L/W	90 135	P/D	90	H/H	45
-----	-----------	-----	----	-----	----

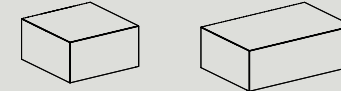

Moduli P 135
D 135 modules

L/W	135	P/D	135	H/H	45
-----	-----	-----	-----	-----	----

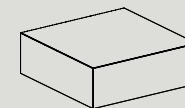

Scalini P 30
D 30 steps

L/W	45 90 135	P/D	30	H/H	22.5
-----	-----------------	-----	----	-----	------



Esempi con foro superiore per presa Sx-Dx
Example with upper hole for socket - L/R

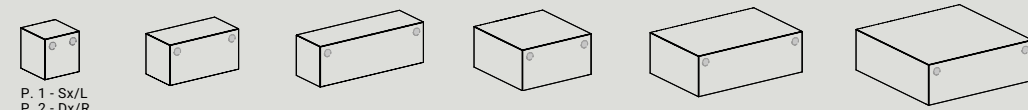

Esempi con foro per contenitore metallico
Example with hole for metal box



Kit sovrapposizione moduli
Module stacking kit

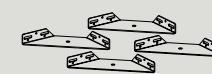

Cuscino seduta
Seat cushion

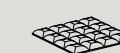

Prese elettriche Ø 7
Electrical outlets Ø 7



EU

UK

US

Contenitori metallici
Metal box

L/W	37	P/D	37	H/H	10 30
-----	----	-----	----	-----	----------

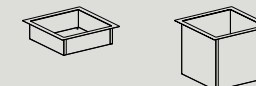

Dimensioni espresse in centimetri
Dimensions stated in centimetres

In fase di ordine dei moduli pedana con fori per prese (P) o per contenitori metallici (V), è obbligatorio specificare la posizione.
When ordering the platform modules with holes for sockets (P) or metal boxes (V), it is mandatory to specify the position.



DV401 - E-MEDIA

Finiture Finishes

E-Media* E-Media*

M Piani scrivania/Schiene/Basamento sp. 25 mm
Worktops/Back panel/Base th. 25 mm

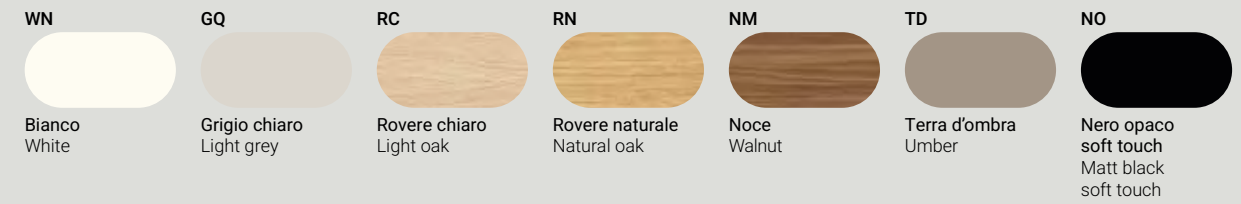

MT Staffe/Carter/Vassoio
Brackets/Caising/Tray

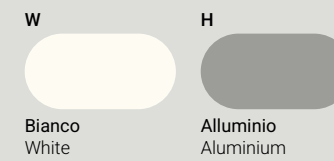

Dati tecnici Technical data

Moduli H 174 H 174 modules

L/W 142.5 | P/D 160 | H/H 174 |
202.5

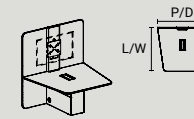

Moduli H 207 H 207 modules

L/W 142.5 | P/D 160 | H/H 207 |
202.5

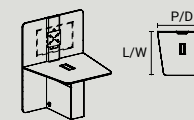

LEGENDA LEGEND

M Melaminico
Melamine

MT Metallo
Metal

* Non in pronta consegna
* Not in prompt delivery



DV420 - MOBILE WALL

Finiture Finishes

Mobile wall*
Mobile wall*

MT Strutture metalliche
Metal structure



W
Bianco
White

A
Antracite
Anthracite

N*
Nero
Black

Dati tecnici Technical data

Mobile wall su ruote - H 180
Mobile wall on castors - H 180

L/W 120 | P/D 42 | H/H 180 |

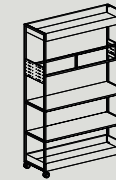

A
Lavagna con staffe per fissaggio
Whiteboard with brackets

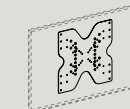

B
Staffa porta monitor
Monitor stand bracke

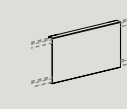

C
Carter per copertura staffe
Bracket covering carter

A	L/W 105	P/D 5	H/H 65
B	L/W 44	P/D 4	H/H 44
C	L/W 36	P/D 2.5	H/H 20

Accessori Accessories

Salita cavi verticale
Vertical cable climb

L/W 5 | P/D 4 | H/H 106 |

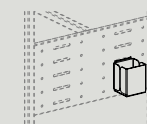

A
Portapenne
Pen holder

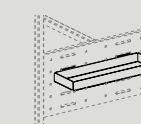

B
Mensola
Shelf

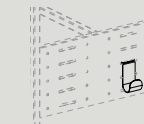

C
Gancio
Hook

A	L/W 6.5	P/D 6.5	H/H 9.5
B	L/W 30	P/D 10	H/H 4.5
C	L/W 4	P/D 4	H/H 9

LEGENDA
LEGEND

MT Metallo
Metal

* Non in pronta consegna
* Not in prompt delivery

Specifiche Tecniche Technical Sheets

Wire Management DV300	E-PLACE DV804	p. 270
	PAG ENTITY DV802 DV801	p. 272
	ENNA DV812	p. 274
	NOBU DV803	p. 275
	TOLEDO DV818	p. 276
	TREKO DV805	p. 278
	OSLO DV817	p. 279
	NIDA DV816	p. 280
	E-MEDIA DV401	p. 281

Plug&Play DV300		p. 282
---------------------------	--	--------

E-PLACE
DV804

Scrivania
Desk



E-PLACE
DV804

Bench
Bench

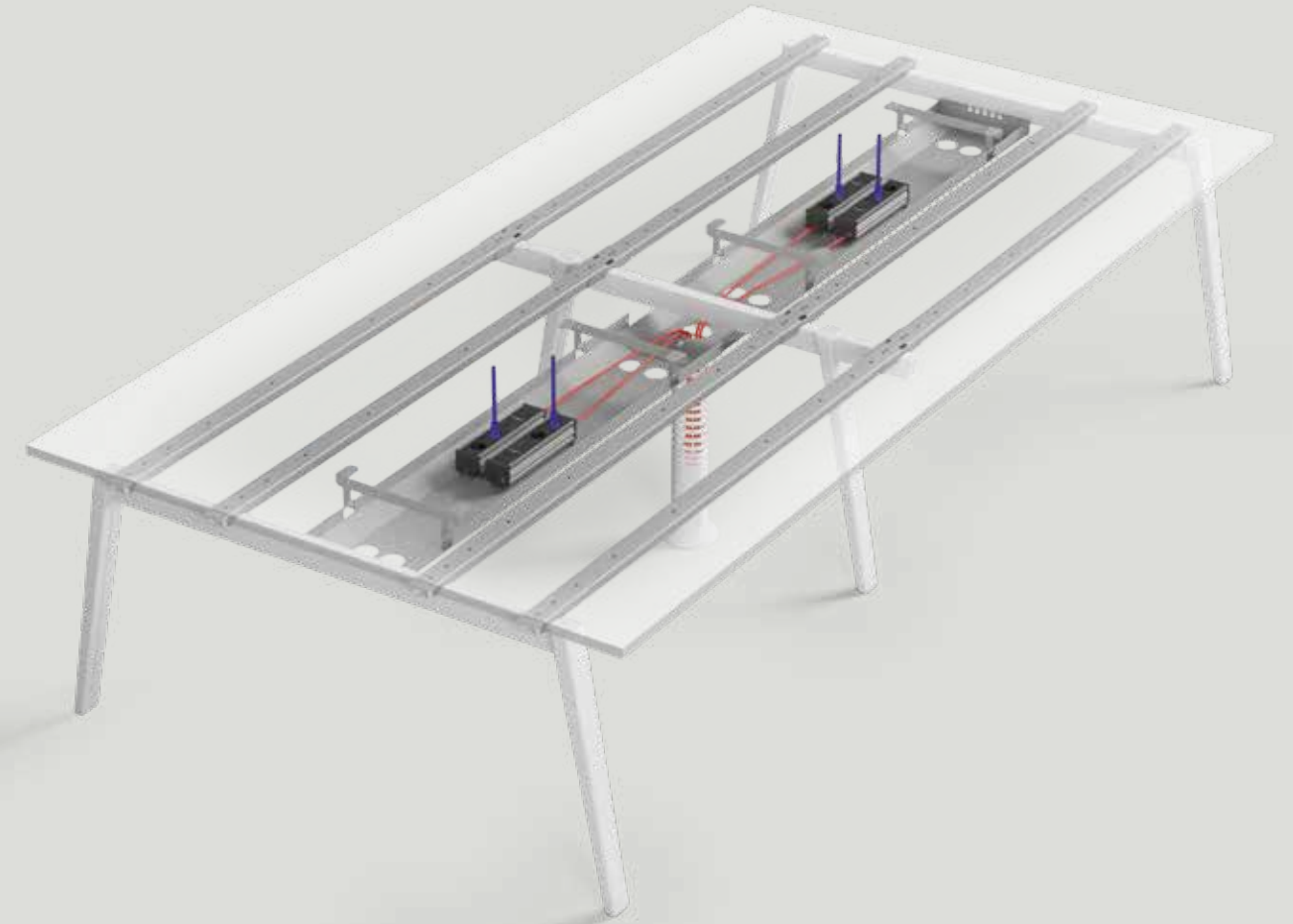

Canale passacavi in lamiera - ispezionabile
Sheet metal cable duct - accessible



Canale passacavi in lamiera verticale - ispezionabile
Vertical sheet metal cable duct - accessible



Canale passacavi in lamiera per bench
Sheet metal cable duct for bench



Ispezionabile
Accessible

PAG | ENTITY
DV802 | DV801

Scrivania
Desk



PAG | ENTITY
DV802 | DV801

Bench
Bench

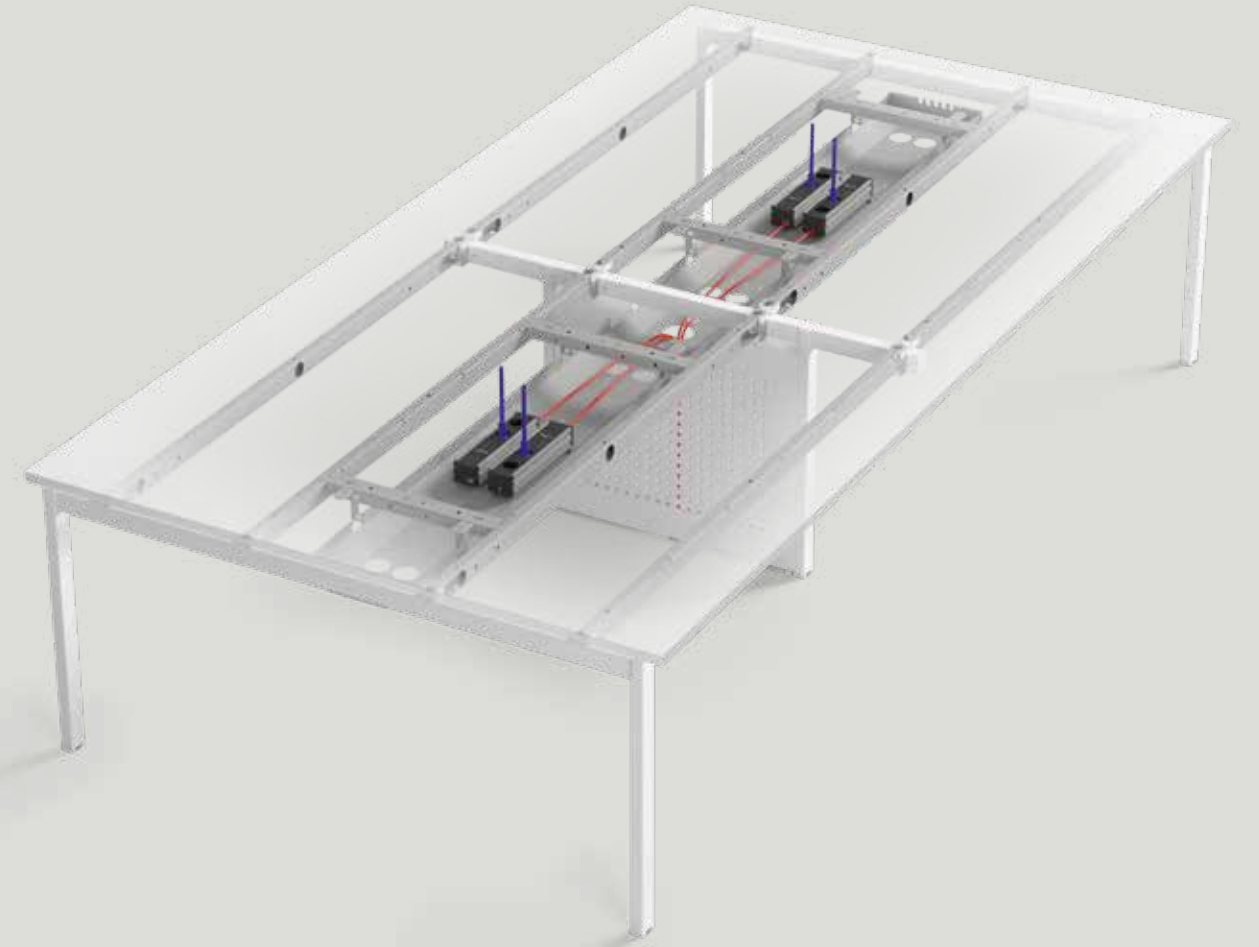

Canale passacavi in lamiera - ispezionabile
Sheet metal cable duct - accessible



Canale passacavi in lamiera verticale - ispezionabile
Vertical sheet metal cable duct - accessible



Canale passacavi in lamiera per bench - ispezionabile
Sheet metal cable duct for bench - accessible



Dettaglio canale passacavi
Detail of sheet metal cable duct



Prolunga in lamiera per canale passacavi per bench
Sheet metal link-piece for bench cable duct

ENNA
DV812

Scrivania
Desk



Bench
Bench



Dettaglio canale passacavi in lamiera per bench - ispezionabile
Detail of sheet metal cable duct for bench - accessible

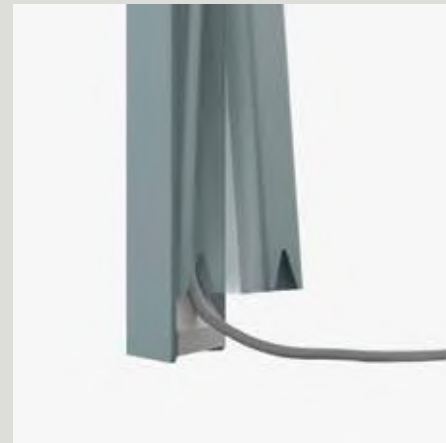

Canale passacavi in lamiera verticale - ispezionabile
Vertical sheet metal cable duct - accessible

NOBU
DV803

Scrivania
Desk



Canale passacavi verticale in lamiera ispezionabile
Vertical sheet metal cable duct - accessible



Passacavi verticale a spirale
Spiral cable duct



Porta Cpu sospeso
Hanging CPU holder

TOLEDO
DV818

Scrivania
Desk



TOLEDO
DV818

Bench
Bench

Canale passacavi in lamiera per bench - ispezionabile
Sheet metal cable duct for bench - accessible

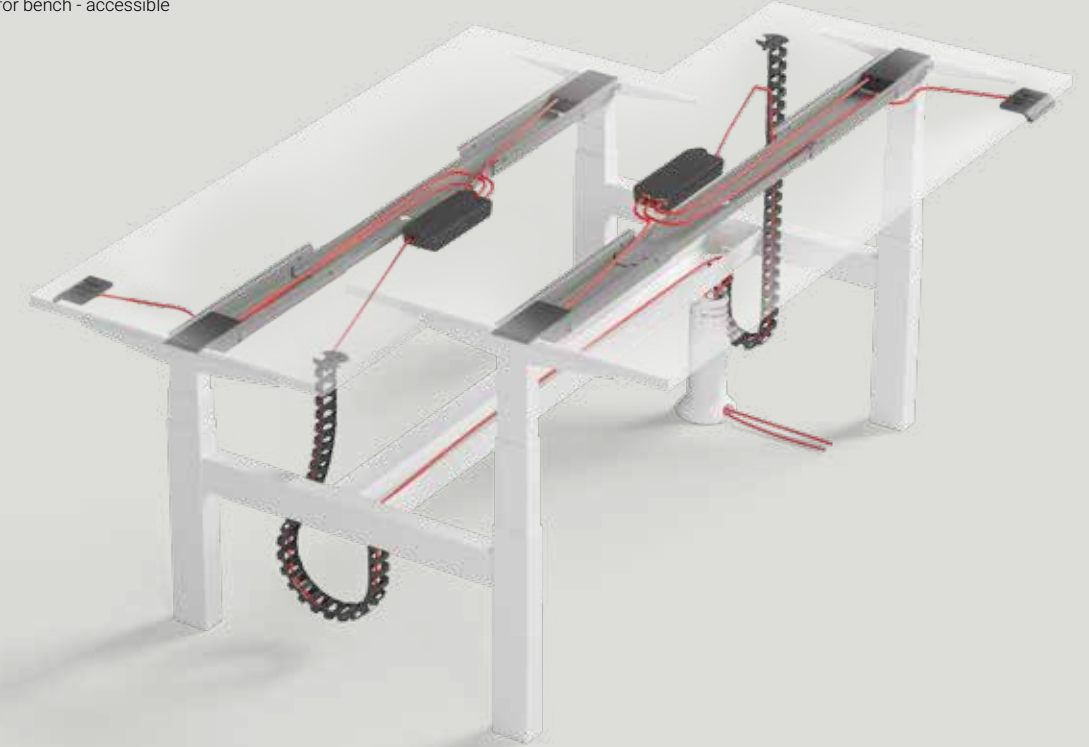

Vertebra passacavi per scrivanie
Cable duc for desks



Carter di copertura per canalina bench
Cover casing for cable duct of bench

Trave telescopica canalizzabile
Vertebra passacavi per bench
Ductable telescopic beam
Cable duc for bench

TREKO
DV805

Scrivania
Desk

Canale passacavi in ABS
Passacavi verticale a spirale
ABS cable duct - accessible
Spiral cable duct



Canale passacavi in lamiera -
ispezionabile
Sheet metal cable duct -
accessible



OSLO
DV817

Scrivania
Desk

Canale passacavi in lamiera - ispezionabile
Sheet metal cable duct - accessible



Canale passacavi in lamiera verticale - ispezionabile
Vertical sheet metal cable duct - accessible

Bench
Bench

Canale passacavi in lamiera per bench - ispezionabile
Sheet metal cable duct for bench - accessible

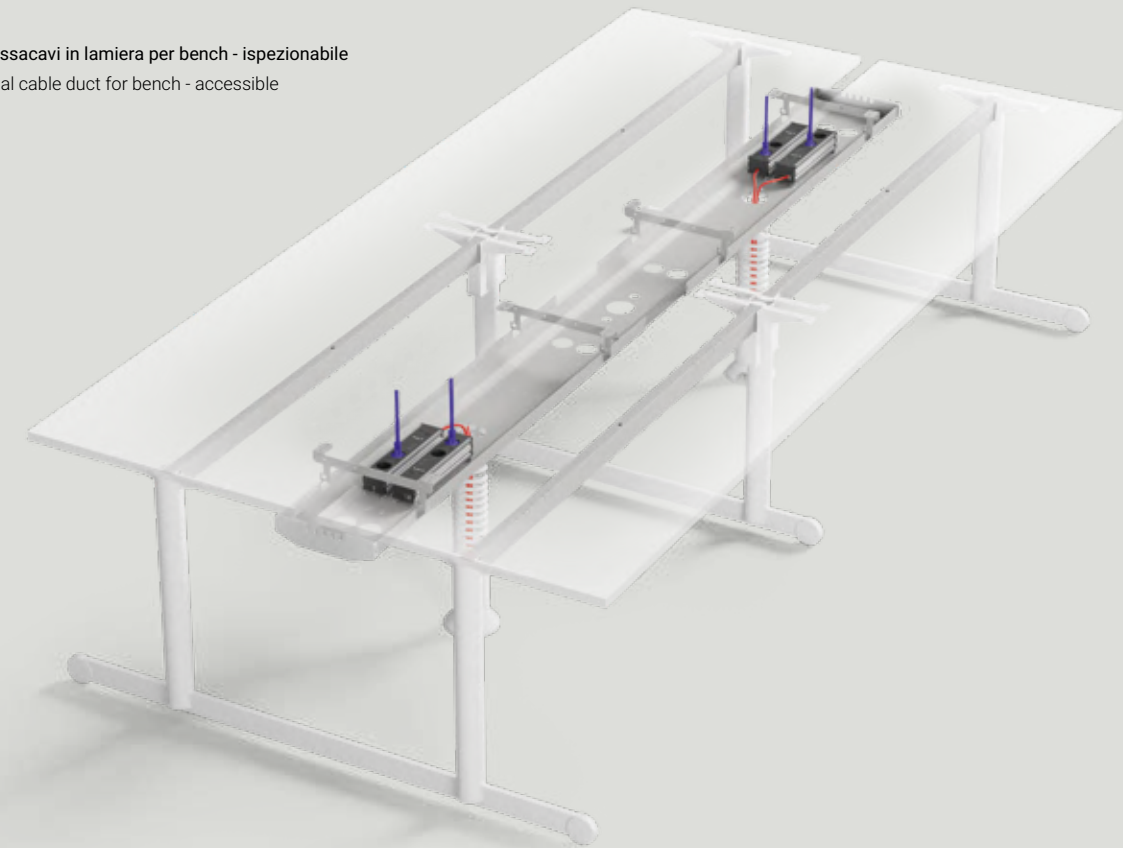

NIDA
DV816

Scrivania
Desk

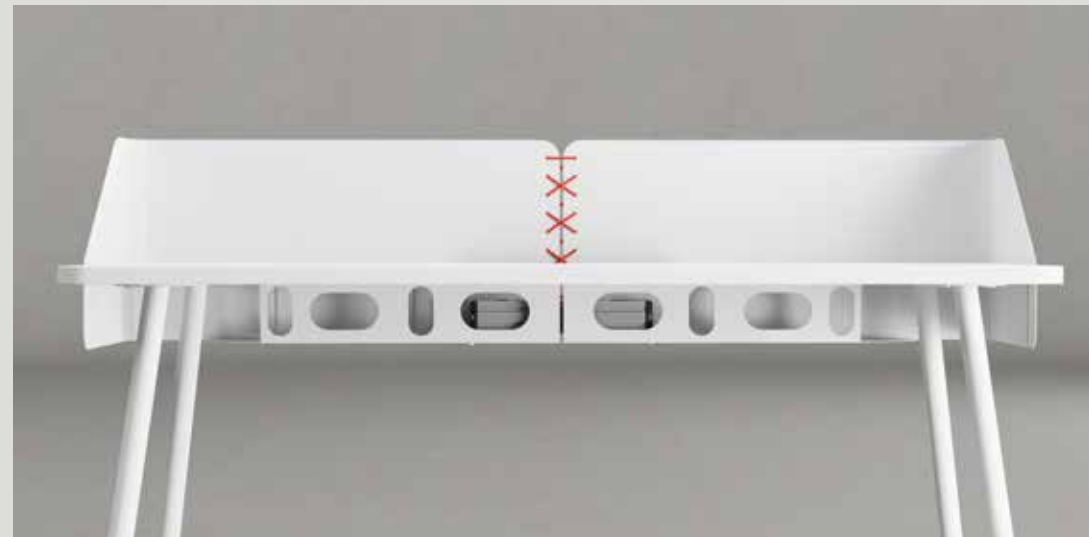

Canale passacavi in lamiera - ispezionabile
Sheet metal cable duct - accessible

E-MEDIA
DV401

Tavolo Riunioni
Meeting Table

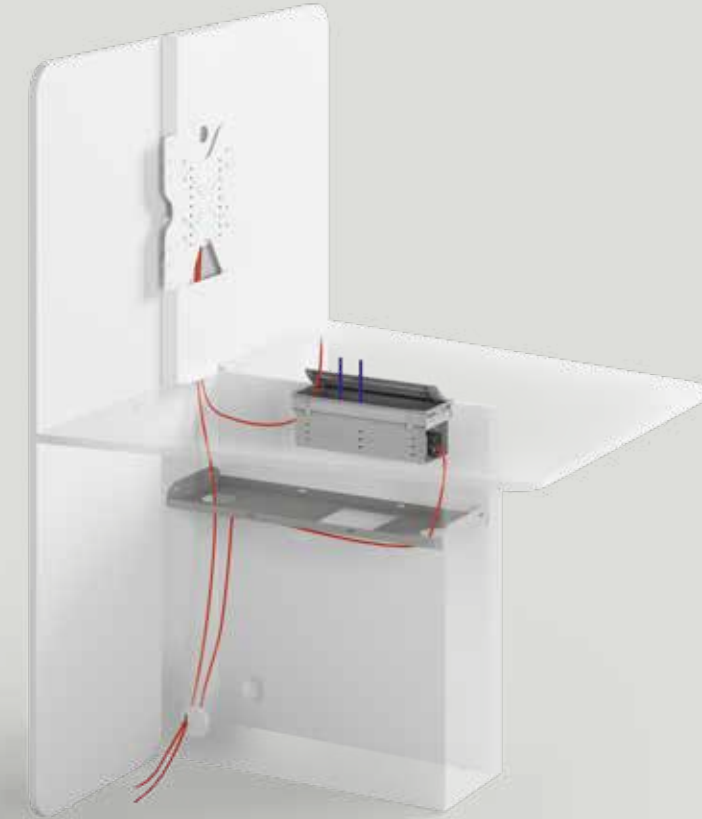

Dettaglio vista interna
Pannello superiore amovibile
Tappo passacavi diam 80 mm
Interior view detail
Removable upper panel
Cable grommet diam 80 mm

Esempi di elettrificazione per workstations PAG ed ENTITY P 158 cm
Examples of electrification for PAG and ENTITY workstations D 158 cm

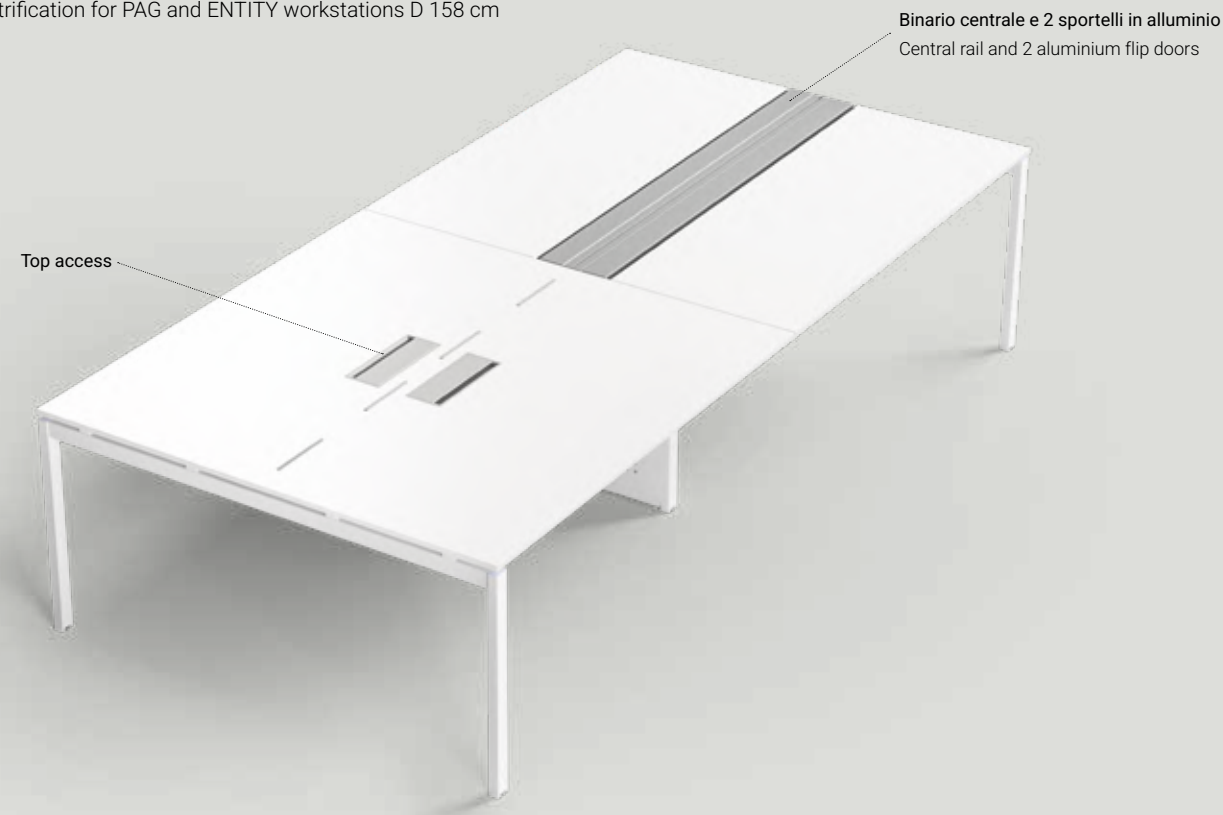

Esempi di elettrificazione per workstations PAG ed ENTITY P 136.5 e P 166.5 cm
Examples of electrification for PAG and ENTITY workstations D 136.5 and D 166.5 cm



Passacavi bicolore in ABS - Ø 8
2 coloured outlet lid - Ø 8



Passacavi in ABS - Ø 6 - 8
ABS outlet lid - Ø 6 - 8



Passacavi in zama - Ø 8
Zamak outlet lid - Ø 8

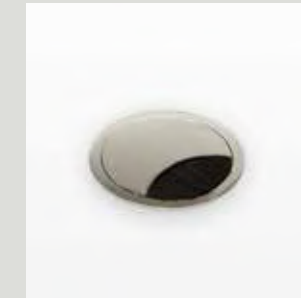

Tappo elettrificato - Ø 8
Electrified grommet - Ø 8



Top access
Top access

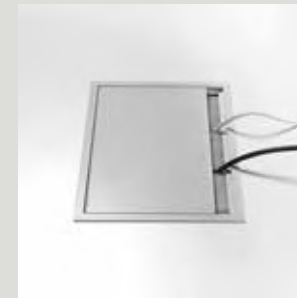

Top access elettrificato per scrivania
Electrified top access for desk



Top access elettrificato per scrivania
Electrified top access for desk

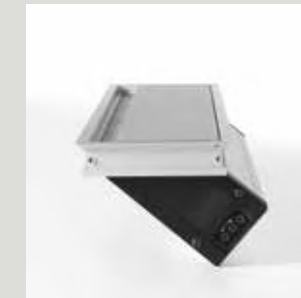

Top access per tavoli riunioni
Top acces for meeting tables

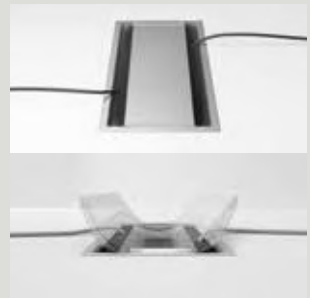

L/W 24 | P/D 10 | H/H 1.5
L/W 32 | P/D 12.3 | H/H 2.4
L/W 32 | P/D 12.3 | H/H 3

L/W 26.3 | P/D 14.8 | H/H 2.5

L/W 26.3 | P/D 14.8 | H/H 2.5

L/W 24.7 | P/D 17.5 | H/H 5
L/W 34.7 | P/D 17.5 | H/H 5
L/W 44.7 | P/D 17.5 | H/H 5

Multipresa elettrificata
Electrified multiple socket



L/W 23.8 | P/D 8.8 | H/H 7.8

Multipresa elettrificata
Electrified multiple socket



L/W 23.2 | P/D 6.2 | H/H 5.1

Multipresa elettrificata
Electrified multiple socket



L/W 12 | P/D 7 | H/H 6.6

Presa USB
USB socket



LEGENDA
LEGEND

■ Bianco
White

■ Alluminio
Aluminium

■ Cromo
Chrome

■ Nero
Black

Immagini puramente indicative. Consultare il Listino Prezzi.
Purely indicative images. See Price List.

Porta CPU con cinghie nere
CPU holder with black belts



Porta CPU su ruote
CPU holder on castors



Braccio porta video
statico su palo
Static arm for video
support on deskbase



Doppio braccio porta video
statico su palo
2 static arms for video
support on pole



Braccio porta video
mobile su piano
Dynamic arm for video
support on deskbase



Doppio braccio porta video
mobile su piano
2 dynamic arms for video
support on deskbase



TIPOLOGIA DI FISSAGGIO
FIXING TIPOLOGY

Fissaggio su piano singolo
Fixing on single worktop



Fissaggio su binario centrale
Fixing on central rail



LEGENDA
LEGEND

Bianco
White
 Alluminio
Aluminium

Cromo
Chrome
 Nero
Black

Immagini puramente indicative. Consultare il Listino Prezzi.
Purely indicative images. See Price List.

Passacavi verticale a spirale
Vertical spiral cable duct



Canalina verticale con zip
Vertical channel with zip



Canale passacavi attrezzabile
Equippable wire management



La natura è il motore che sostiene il mondo in cui viviamo. Lavorare in un'ottica green è un impegno e un dovere per avere i piedi radicati a terra nel presente, ma lo sguardo sempre rivolto al futuro.

Per il benessere del domani è indispensabile fare oggi delle scelte sostenibili. Selezioniamo con grande attenzione la qualità dei materiali dei nostri prodotti e soddisfiamo gli standard più rigorosi: prodotti durevoli e sostenibili. Una costante ricerca per un miglioramento continuo nei processi produttivi di ogni nostra attività: essere green è la nostra natura, non solo parole.

Ecco i fatti: le nostre certificazioni aziendali e di prodotto, sono in costante aggiornamento, poiché essere green vuol dire soprattutto sapersi sempre rinnovare per crescere.

Nature is the engine that sustains the world we live in. Working in a green perspective is a commitment and a duty to have one's feet firmly rooted in the present, but one's gaze always turned towards the future.

For the well-being of tomorrow, it is essential to make sustainable choices today. We carefully select the quality of the materials in our products and meet the strictest standards: durable and sustainable products. Constant research for continuous improvement in the production processes of all our activities: being green is our nature, not just words.

Here are the facts: our company and product certifications are constantly being updated, because being green means above all always knowing how to renew in order to grow.

Scopri le nostre certificazioni:
Discover our certifications:

