

abaco

BATHROOM (R) EVOLUTION

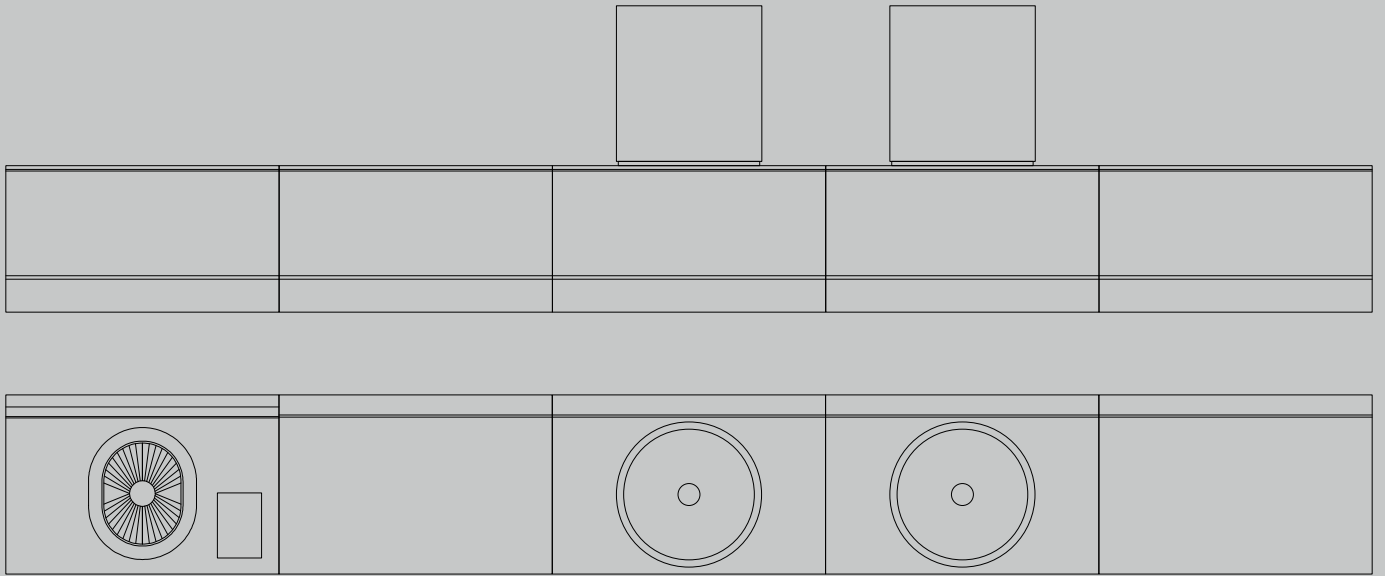

CEQ

The new bathroom dimension

"ABACO is a common thread that runs through my entire life. It began when I was just a boy, following my father to construction sites to see how water pipes were laid.

That extraordinary experience of bathroom design had an impact on me and I endeared the bathroom because of its richness in technology and innovation. My professional life however, has always been a search for simplicity and order, so I began to think about the beauty of creating a modular container that would accommodate all the functions of the bathroom in a way that it was simple and straightforward. Only steel could convey all of this: an extremely hygienic, antibacterial material, preserver of experience, knowledge and innovation, a friend."

NATALINO MALASORTI



Integrated Modular System

- A unique bathroom composition
- A large range of coverings - steel, marbles and wood
- A hidden toilet with a heated seat in stainless steel
- An integrated plumbing system and electrical equipment
- A hidden WC flush and toilet cleaning system
- A bidet toilet spray for women and men
- Two different sizes of backlit mirrors
- More chests of drawers covered in leatherette



The purity of stainless steel

ABACO is made entirely of AISI 316L stainless steel, an alloy with a reduced content of carbon, universally recognised for the characteristics of hygiene and excellent resistance to corrosion. Thanks to its chemical composition, AISI 316L stainless steel does not oxidize and does not rust in contact with external agents such as water and air. The natural protective film that stainless steel is equipped with makes the material resistant over time and always restorable. CEA products are entirely made with the aid of mechanical procedures that maintain unaltered the unique and extraordinary characteristics of the alloy. The stainless steel used for CEA production is not treated with either chrome plating or galvanic process, preserving the properties of an ecological, eco-friendly, completely recyclable and highly hygienic product.





<
MIR02 - Extra clear mirror Ø 550 mm
thickness 4 mm, polished edge, sandblasted
back edge 20 mm with front 3000K LED
lighting. Stainless steel fixing structure

WBN03 - Countertop washbasin (Ø 425 mm,
H. 470 mm) with overflow and siphoned up
& down waste drain completely inspectable

Tap: OPUS collection

>
ABC01 - Toilet module with integrated bidet
function and jet cleaner, heated seat with soft-
open and soft-close cover, hidden toilet roll
holder. Drawer with leatherette lining and 3000K
LED lighting activation via presence sensor

Material: Stainless Steel satin finish





Integrated Lighting System

This monolithic composition is equipped with a plinth with floor lighting as a courtesy light that also runs along the entire rear of the volume so as to illuminate the wall against which it is leaning. Dimmable LED lighting 3000K.





MIR02 - Extra clear mirror Ø 550 mm thickness 4 mm, polished edge, sandblasted back edge 20 mm with front 3000K LED lighting. Stainless steel fixing structure

WBN04 - Freestanding washbasin (Ø 425 mm, H. 900 mm) with 3000K LED floor lighting, overflow, floor drainage and siphoned up & down waste drain completely inspectable

Tap: CROSS Collection

Material: Stainless Steel satin finish and basin in Copper satin finish





Special finishes

Special finishes treatments are the result of an accurate work of chromatic choice and technological development that is based on a high thickness deposition of mixtures of mineral powders and graphite. Thanks to this process, the steel surface is even more resistant against cleaning and chemical agents. The CEA special finishes emphasize the unique properties of AISI 316L stainless steel, increasing the gloss and hardness of its surface. Special finishes are ecological and biocompatible.

WBN03 - Countertop washbasin (Ø 425 mm, H. 470 mm) with overflow and siphoned up & down waste drain completely inspectable

Tap: REGOLO collection

Material: Stainless Steel / Black Diamond satin finish



Comfort and hygiene

ABACO WC module promotes gender equality in toilet use with increased comfort and relaxation thanks to the sitting position on an ergonomic heated seat, guarantees hygiene and ease of cleaning as it is made of stainless steel. By eliminating the removable seat, ABACO prevents the transfer of bacterial contaminations on the surface.





Solid Surface

ABACO is available in solid surface cladding for a minimalistic and pure design. Combinable with details in satin steel finish or special finish, it reveals aesthetic and technological innovation.



ABC01 - Toilet module with integrated bidet function and jet cleaner, heated seat with soft-open and soft-close cover, toilet roll holder, drawer with leatherette lining and 3000K LED lighting activation via presence sensor

ABC08 - Shower bench module with drawer for shower gel and sponges, perforated bottom for water drainage and 3000K LED lighting activation via presence sensor

Material: Solid Surface and Black Diamond satin finish



Natural Stone

The modularity of the composition is enriched by natural cladding materials such as stone, marble and wood, which allow the product to be interpreted in different finishes and shades. The innovative character of ABACO is highlighted by the thickness of the front of the drawer units and the cover, which is only 10 mm for a particularly clean and elegant volume.



WBN03 - Countertop washbasin (Ø 425 mm, H. 470 mm) with overflow and siphoned up & down waste drain completely inspectable

Tap: CARTESIO collection

Material: Black Diamond satin finish and basin in polished finish

ABC04 - Module for countertop washbasin, predisposition for one-hole tap on the right, drawer with leatherette lining and 3000K LED lighting activation via presence sensor

Material: Breccia Imperiale Marble honed surface and Stainless Steel





Leatherette

ABACO is a large container that allows you to store all bathroom toiletries and personal care. The drawer units are completely removable and lined with leatherette which is available in different colours to match the external finish whether it is steel, marble, stone or wood. The choice of leatherette for lining the drawers is functional in simplifying the cleaning of the surfaces.





ABACO is a product capable of transforming itself with extreme ease thanks to the customization of its finishes, while maintaining the same steel core which makes it an eternal and unique product.

<
MIR04 - Extra clear mirror Ø 800 mm thickness 4 mm, polished edge, sandblasted back edge 20 mm with front 3000K LED lighting. Stainless steel fixing structure

ABC02 - Module for countertop washbasin, drawer with leatherette lining and 3000K LED lighting activation via presence sensor

Tap and accessories: LUTEZIA Collection

Material: Fior di Bosco Marble and Bronze satin finish

WBN04 - Freestanding washbasin (Ø 425 mm,
H. 900 mm) with 3000K LED floor lighting,
overflow, floor drainage and siphoned up &
down waste drain completely inspectable

Tap: FLAG collection

Material: Bronze satin finish



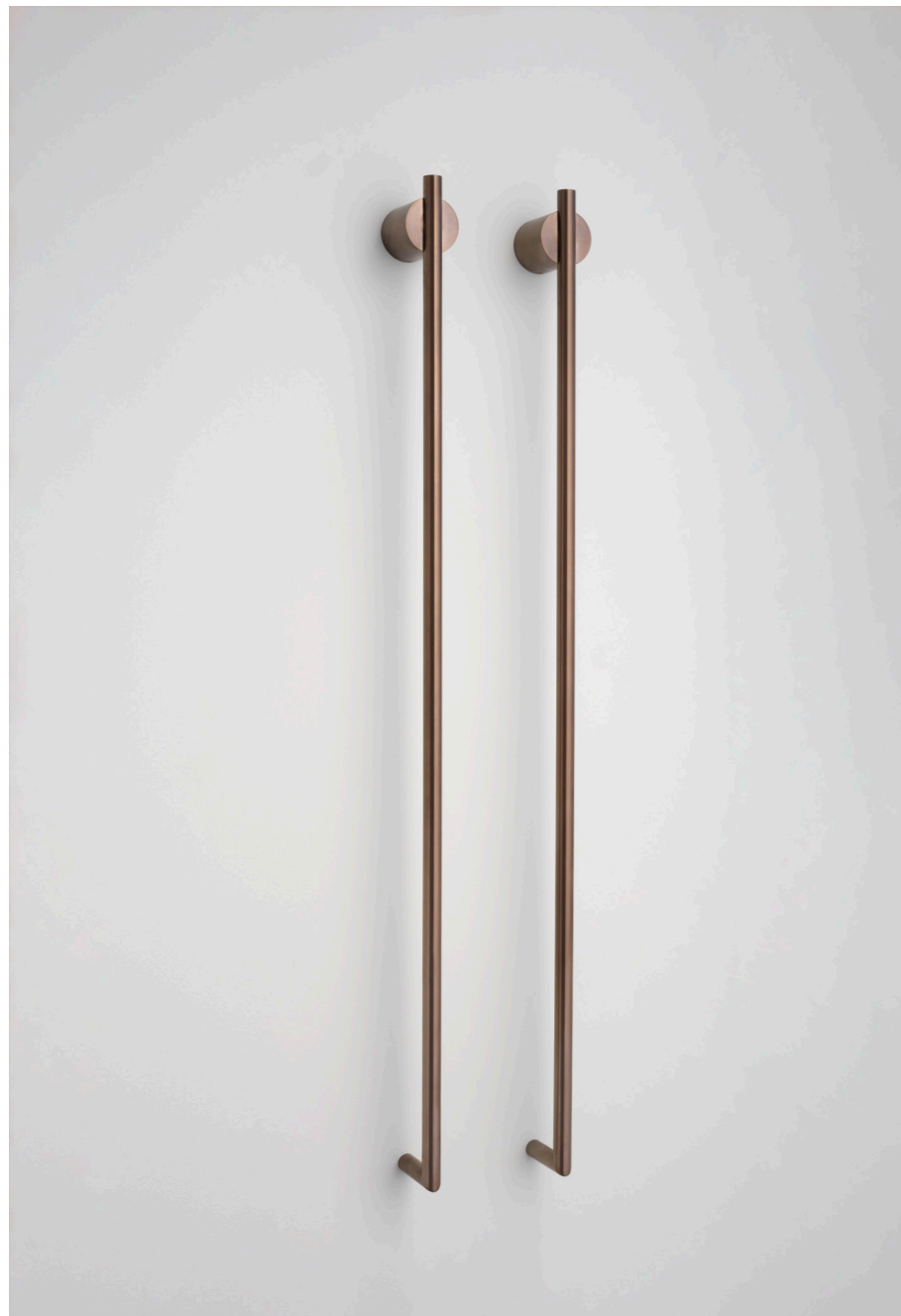

<
EQB22 - Electric bathrobe warmer L. 1.060 mm

>
ABC09 - Decorative wall disc Ø 1.600 mm

EQB65 - Electric towel warmer L. 580 mm and L. 1.060 mm

Material: Bronze satin finish and Fior di Bosco Marble

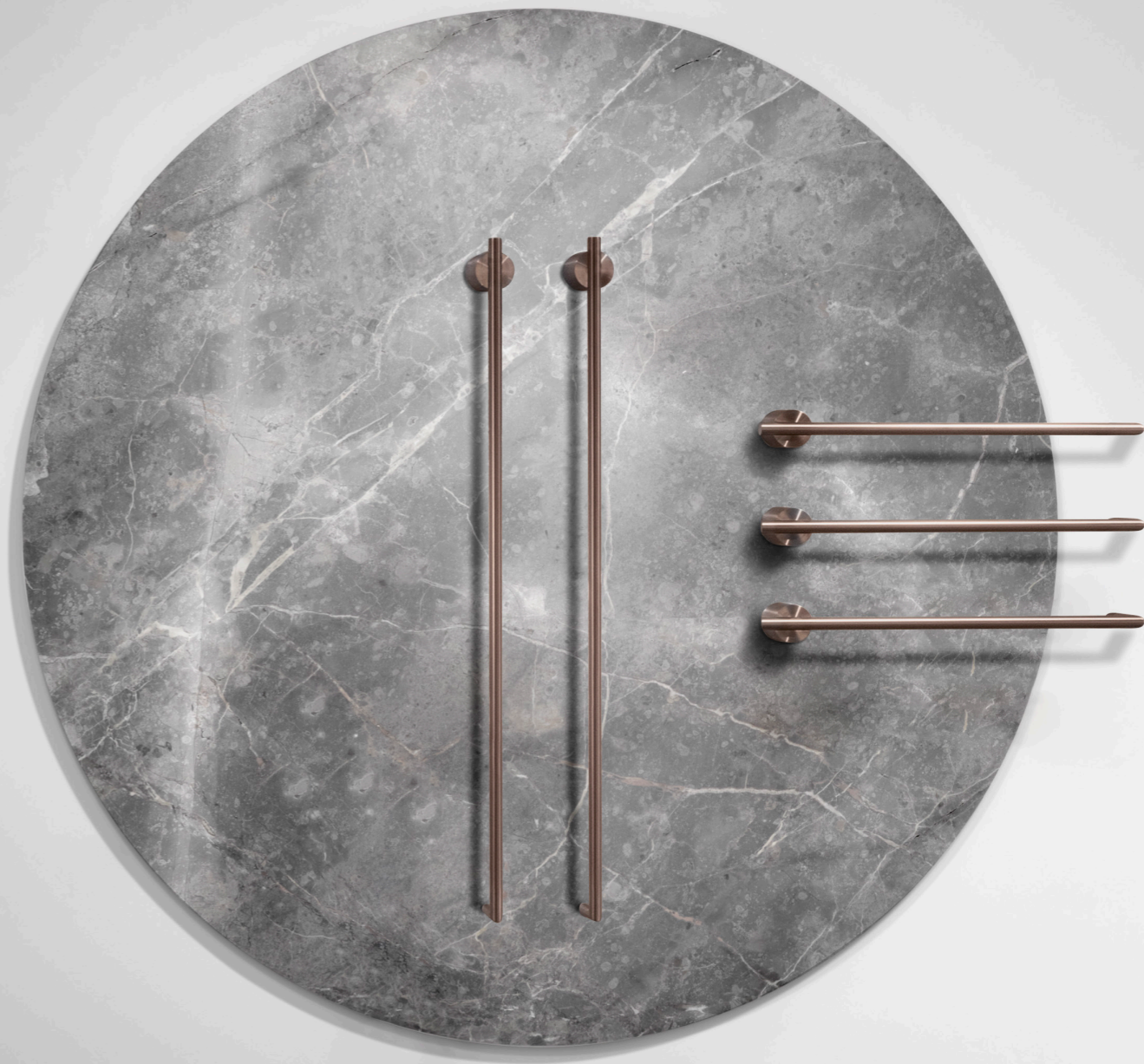

Wood essences and special finish

ABACO maintains the integrity of the woodgrain along the entire length of the composition, guaranteeing an extremely refined and exclusive effect.

ABACO is available in Canaletto Walnut, Oak, Burma Teak, Eucalyptus: all the wood come from certified forests.

MIR02 - Extra clear mirror Ø 550 mm thickness 4 mm, polished edge, sandblasted back edge 20 mm with front 3000K LED lighting. Stainless steel fixing structure

ABC02 - Module for countertop washbasin, drawer with leatherette lining and 3000K LED lighting activation via presence sensor

Tap: GIOTTO collection

Material: Canaletto Walnut and Black Diamond satin finish





Integrated modular system

ABACO is a modular, sober, and linear system, which hides sanitary functions and plant-engineering technology within a single volume aimed at adapting to any room of a house. It presents itself as a silent and elegant object that when in function, it embodies all the strength of its innovation.

The toilet which is an Industrial Invention Patent by Natalino Malasorti himself, merges drain, flush and bidet functions. ABACO is entirely made of stainless steel, a high-performance material, hygienic, antibacterial, totally recyclable and ideal in a bathroom environment. Its durability over time is the essence of quality and ecology. Even the special finishes (Black Diamond, Light Gold, Copper and Bronze) in which ABACO is available are obtained through environmentally friendly processes. To enrich the modularity of the compositions, natural cladding materials such as marble and wood are added allowing different interpretations and shades for an even more sculptural and refined style.

Drawer module

ABC05

Drawer module with leatherette lining and 3000K LED lighting activation via presence sensor



Electrical connection is needed if you do not have the toilet module

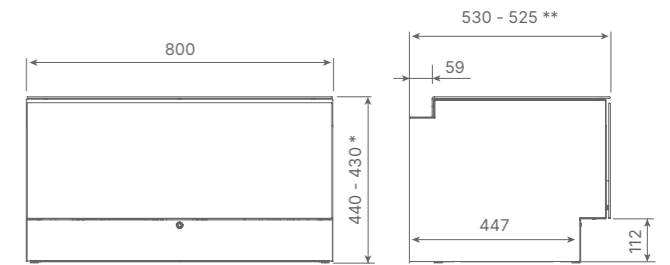
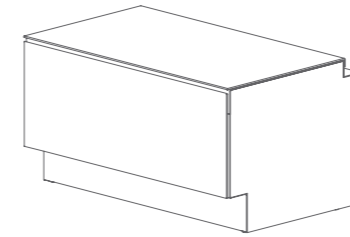

* 440: marble, wood, solid surface
430: stainless steel

** 530: marble, wood, solid surface
525: stainless steel

Toilet module

ABC01

Toilet module with integrated bidet function and jet cleaner, heated seat with soft-open and soft-close cover, toilet roll holder, drawer with leatherette lining and 3000K LED lighting activation via presence sensor



Electrical connection is needed



Built-in fitting for hydraulic system

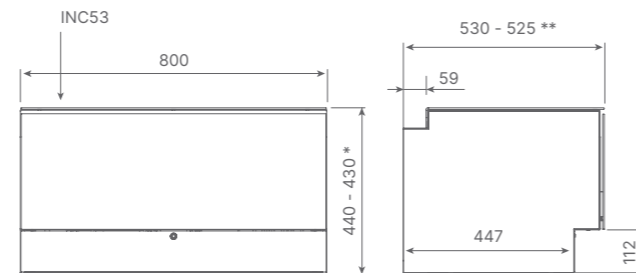
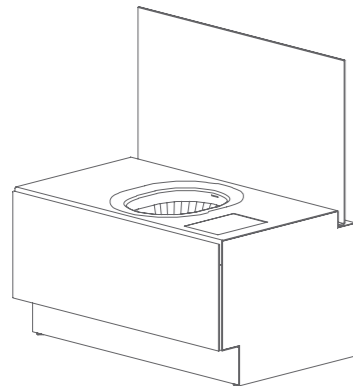

* 440: marble, wood, solid surface
430: stainless steel

** 530: marble, wood, solid surface
525: stainless steel

Module for countertop washbasin

ABC02

Module for countertop washbasin, drawer with leatherette lining and 3000K LED lighting activation via presence sensor



Electrical connection is needed if you do not have the toilet module

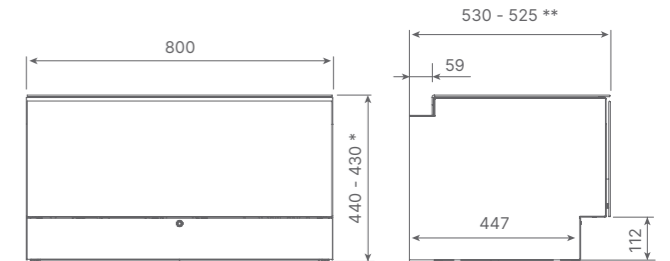
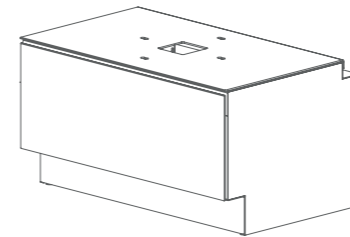

* 440: marble, wood, solid surface
430: stainless steel

** 530: marble, wood, solid surface
525: stainless steel

Module for countertop washbasin, predisposition for one-hole tap

ABC03

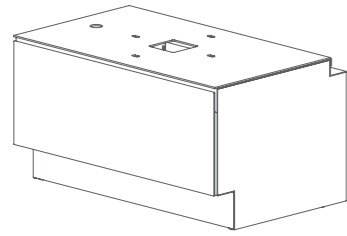

Module for countertop washbasin, predisposition for one-hole tap on the left, drawer with leatherette lining and 3000K LED lighting activation via presence sensor



Electrical connection is needed if you do not have the toilet module

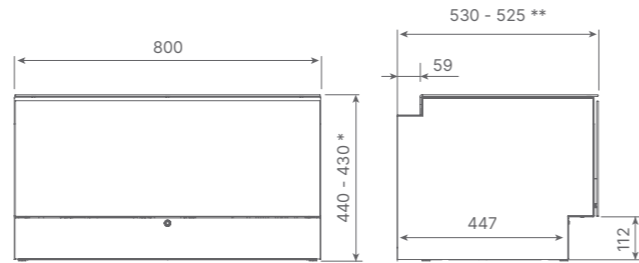

* 440: marble, wood, solid surface
430: stainless steel

** 530: marble, wood, solid surface
525: stainless steel

Shower bench module

ABC07

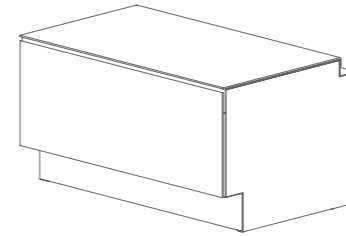

Shower bench module with 3000K LED lighting activation via presence sensor



Electrical connection is needed if you do not have the toilet module

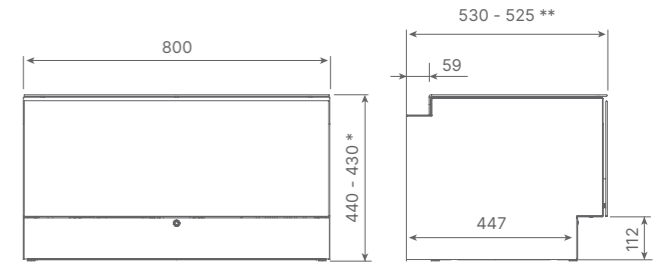

* 440: marble, solid surface
430: stainless steel

** 530: marble, solid surface
525: stainless steel

ABC04

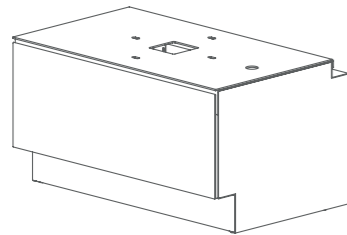

Module for countertop washbasin, predisposition for one-hole tap on the right, drawer with leatherette lining and 3000K LED lighting activation via presence sensor



Electrical connection is needed if you do not have the toilet module

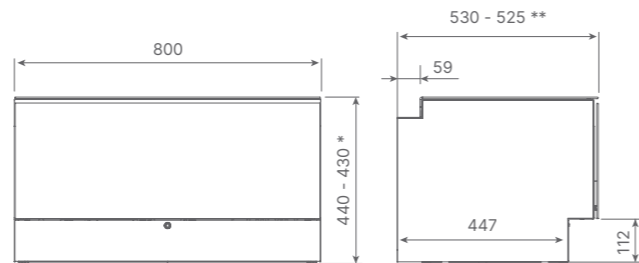

* 440: marble, wood, solid surface
430: stainless steel

** 530: marble, wood, solid surface
525: stainless steel

ABC08

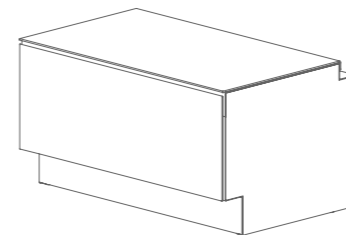

Shower bench module with drawer for shower gel and sponges, perforated bottom for water drainage and 3000K LED lighting activation via presence sensor



Electrical connection is needed if you do not have the toilet module

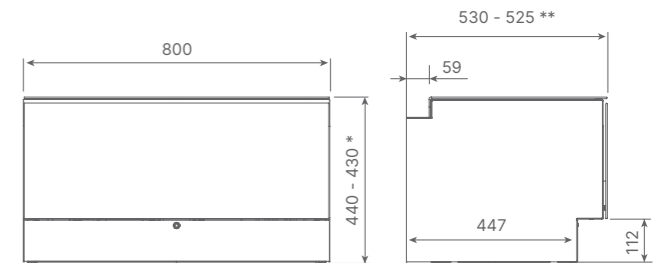

* 440: marble, solid surface
430: stainless steel

** 530: marble, solid surface
525: stainless steel

Decorative wall disc

ABC09

Decorative Wall Disc of 1600 mm diameter in Marble with holes for EQB65 towel warmer composition

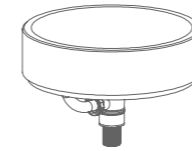
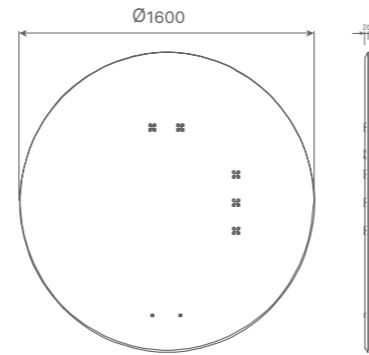
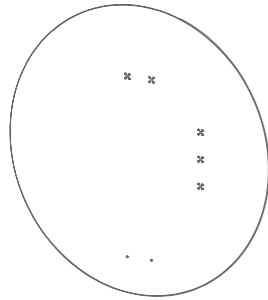

Countertop washbasin

WBN02

Countertop washbasin (Ø 425 mm, H. 125 mm) with overflow and siphoned up & down waste drain completely inspectable

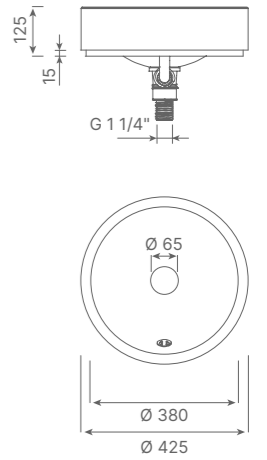

Countertop/undermount washbasin

WBN01

Countertop/undermount washbasin (Ø 425 mm) with overflow and siphoned up & down waste drain completely inspectable

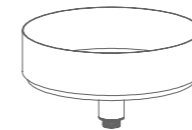
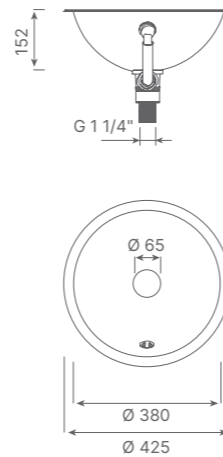

WBN06

Countertop washbasin (Ø 425 mm, H. 120 mm) without overflow and with siphoned free flow drain completely inspectable

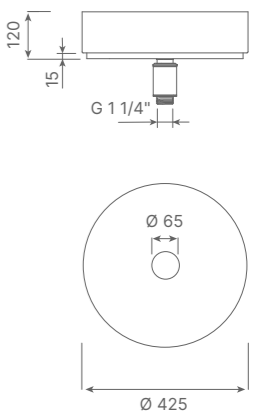

Wall hung washbasin

WBN07

Wall hung washbasin (Ø 425 mm, H. 120 mm) without overflow and with free flow drain

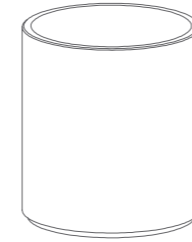
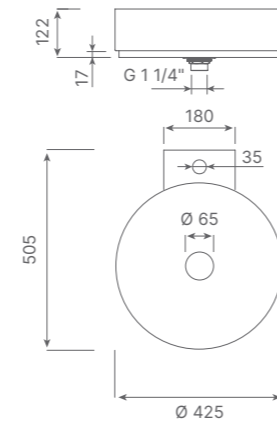
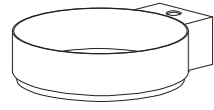

WBN08

Countertop monobloc stone washbasin (Ø 425 mm, H. 470 mm) with siphoned waste drain completely inspectable

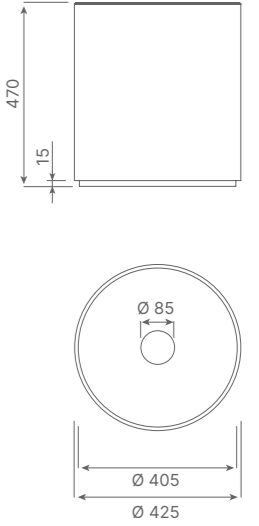

Countertop washbasin

WBN03

Countertop washbasin (Ø 425 mm, H. 470 mm) with overflow and siphoned up & down waste drain completely inspectable

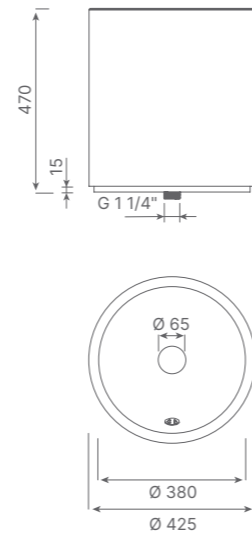
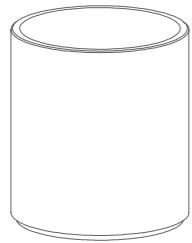

WBN04

Freestanding washbasin (Ø 425 mm, H. 900 mm) with 3000K LED floor lighting, overflow, floor drainage and siphoned up & down waste drain completely inspectable

 Electrical connection is needed

Freestanding washbasin

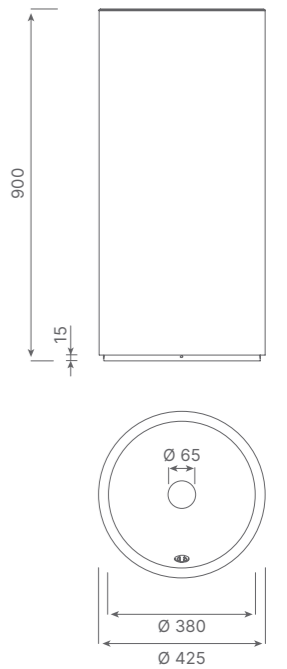

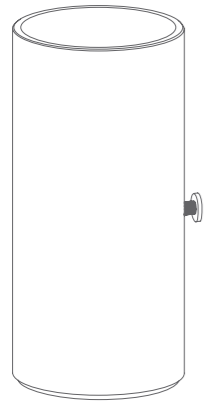

WBN05

Freestanding washbasin (Ø 425 mm, H. 900 mm) with 3000K LED floor lighting, overflow, wall drainage and siphoned up & down waste drain completely inspectable

 Electrical connection is needed

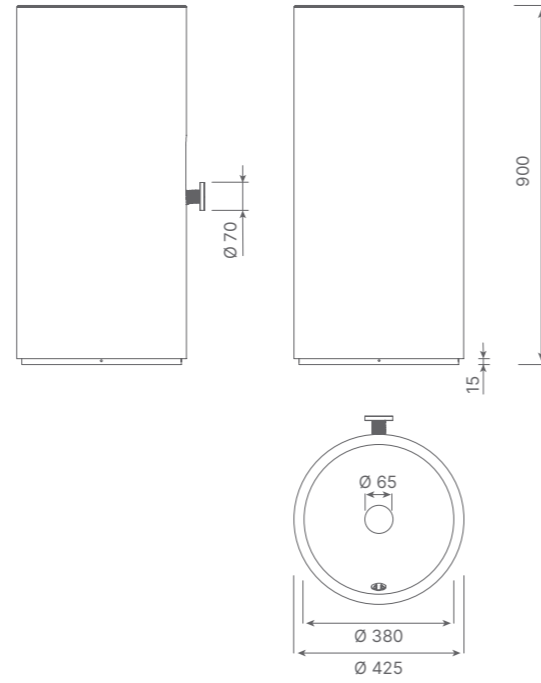

Mirror

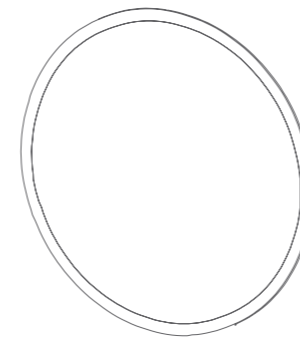
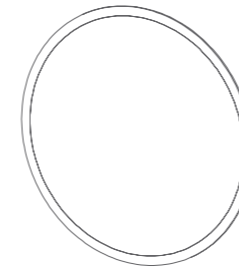
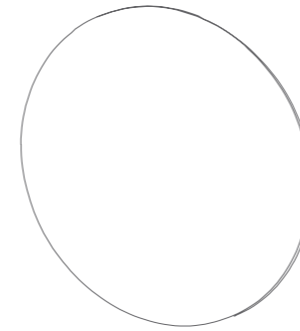

MIRO3

Extra clear mirror Ø 800 mm, thickness 4 mm, polished edge with stainless steel fixing structure

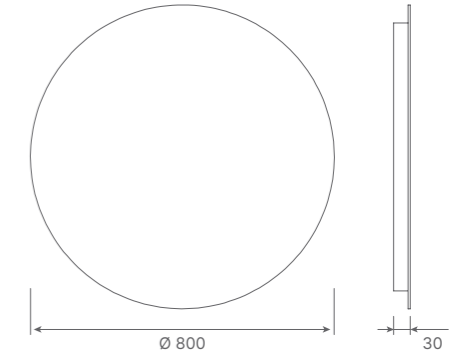

MIRO2

Extra clear mirror Ø 550 mm thickness 4 mm, polished edge, sandblasted back edge 20 mm with front 3000K LED lighting. Stainless steel fixing structure

 Electrical connection is needed

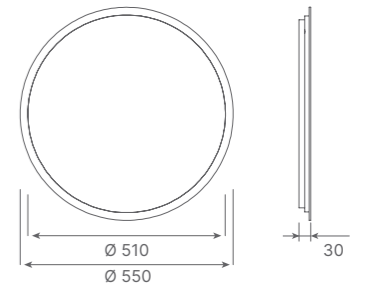

MIRO1

Extra clear mirror Ø 550 mm, thickness 4 mm, polished edge with stainless steel fixing structure

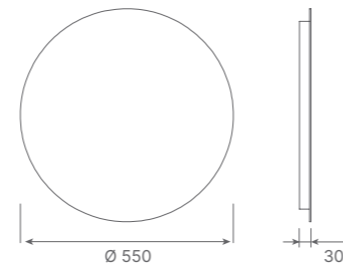
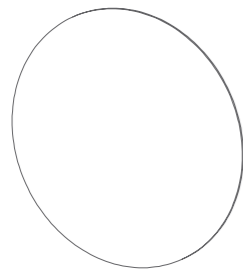

MIRO4

Extra clear mirror Ø 800 mm thickness 4 mm, polished edge, sandblasted back edge 20 mm with front 3000K LED lighting. Stainless steel fixing structure

 Electrical connection is needed

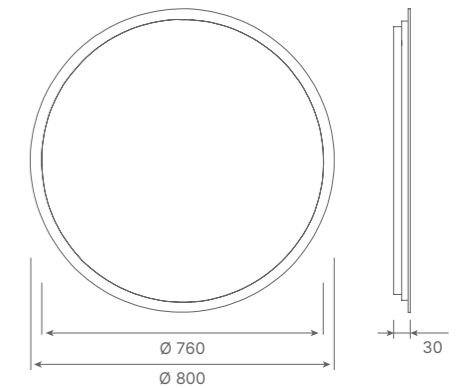



ceadesign.it

Headquarters and Factory

CEADESIGN
Via Brenta 8
36020 Pove del Grappa - Italy
+39 0424 572309

Showroom

CEA MILANO
Via Brera 9
20121 Milano - Italy
+39 02 91526071

CEA GHENT
Kleindokkaai 20
9000 Ghent - Belgium
+32 9 253 49 74



CEADESIGN reserves the right to change without prior notice materials, finishes and drawings. The images are indicative. Any errors and/or misprints can't be a motive for any kind of claim. Catalogue not intended for sale.

This catalogue has been printed on Ecological paper produced without the use of chlorine.



